



SOLVENT RECYCLERS SR30-30V & 60-60V



AUTO-FILL OPTION



MODEL SR30	PART # 325030
MODEL SR60	PART # 325060
MODEL SR30V	PART # 325031
MODEL SR60V	PART # 325061

- Warranty
- Safety
- Operation
- Service parts
- Accessory Information
- Registration Form



QPS Listed Mark - Canada / United States
Conforms to UL 2208
Certified to CSA C22.2 No. 30

INSTRUCTION MANUAL



TABLE OF CONTENTS

	Page
LIMITED WARRANTY.....	4
SOLVENT RECYCLER SPECIFICATIONS.....	5
SAFETY AND WARNINGS	6
SAFETY AND WARNINGS (CONT'D).....	7
SAFETY RULES (CONT'D)	8
SAFETY RULES (END)	9
OBJECTIVES.....	10, 11
WARNINGS.....	12
ENVIRONMENTAL PROTECTION - INSTALLATION	13
ELECTRICAL CONNECTIONS.....	14
INSTALLATION DRAWINGS	15
KEYBOARD OPERATIONS	16, 17
STARTING PROCEDURES	18, 19
TEMPERATURE AND CYCLE TIME SELECTION.....	20, 21
STARTING PROCEDURES - CYCLE	22
FLAMMABLE SOLVENTS	23
NON - FLAMMABLE CHLORINATED SOLVENTS.....	24
TROUBLESHOOTING.....	25 to 28
THERMIC OIL CHANGING PROCEDURES	28
REPLACING THE BOILER GASKET.....	30
THERMAL OIL CHANGE PROCEDURE.....	31
SR30 - SCHEMATIC OF UNIT.....	32
SR60 - SCHEMATIC OF UNIT.....	33
SR30/30V SCHEMATIC OF UNIT - TOP VIEW	34
SR60/60V SCHEMATIC OF UNIT - TOP VIEW	35



TABLE OF CONTENTS

	Page
SR30 & SR60 SCHEMATIC OF UNIT - OIL CHAMBER	36
SR30/60 SCHEMATIC OF UNIT - REAR VIEW	37
AUTO-FILL.....	38
AUTO-FILL : INTERIOR BOILER & DETAILS	39
SCHEMATIC OF UNIT - CONTROL BOARD	40
SCHEMATIC OF UNIT - ELECTRICAL BOXES	41
SR30 ELECTRICAL DRAWING.....	42
SR60 ELECTRICAL DRAWING.....	43
OPTIONAL VACUUM DIAGRAM.....	44
OPTIONAL VACUUM DISTILLATION SECTION	45
OPTIONAL VACUUM DISTILLATION SECTION	46
OPTIONAL VACUUM DISTILLATION SECTION	47
OPERATING PRINCIPLES - VACUUM DISTILLATION	48
OPERATING METHODS	48
STARTING OPERATIONS	49
INSTALLATION (AT VACUUM CONDITION).....	49
SR30V - OPTIONAL VACUUM DISTILLATION	50
SR60V - OPTIONAL VACUUM DISTILLATION	51
OPTIONAL VACUUM INSTALLATION	52
AUTOMATIC FILLING AND SOLVENT TRANSFER SYSTEM (OPTIONAL).....	53
DOUBLE DIAPHRAGM PUMP MODEL A050 M 1/2"	54 TO 72
IMPORTANT ADVICE	73
IST WARRANTY REGISTRATION	74
INFORMATION - TECHNICAL ASSISTANCE.....	75
ABOUT THE COMPANY	76



LIMITED WARRANTY

ISTpure warrants all equipment led in this manual which is manufactured by ISTpure and bearing its name, to be free from defects in material and workmanship on the date of sale by an authorized ISTpure distributor to the original purchaser for use. Notwithstanding any special, extended or limited warranty published by ISTpure will, for a period of TWELVE (12) months from the date of sale, repair or replace any part of the equipment determined by ISTpure to be defective. This warranty applies only when the equipment is installed, operated and maintained in accordance with ISTpure's written recommendations.

This warranty does not cover, and ISTpure shall not be liable for general wear and tear, or any malfunction, damage or wear caused by faulty installation, misapplication, abrasion, corrosion, inadequate or improper maintenance, negligence, accident, tampering, or substitution of non-ISTpure component parts. Nor shall ISTpure be liable for malfunction, damage or wear caused by the incompatibility with ISTpure equipment with structures, accessories, equipment or materials not supplied by ISTpure, or the improper design, manufacture, installation, operation or maintenance of structures, accessories, equipment or materials not supplied by ISTpure.

This warranty is conditioned upon the prepaid return of the equipment claimed to be defective to an authorized ISTpure distributor for verification of the claimed defect. If the claimed defect is verified, ISTpure will repair or replace free of charge any defective parts. The equipment will be returned to the original purchaser, transportation prepaid. If the inspection of the equipment does not disclose any defect in material or workmanship, repairs will be made at a reasonable charge, which charges may include the costs of parts, labor, and transportation.

THIS WARRANTY IS EXCLUSIVE, AND IS IN LIEU OF ANY OTHER WARRANTIES, EXPRESSED OR IMPLIED, INCLUDING BUT NOT LIMITED TO WARRANTY OF MERCHANTABILITY OR WARRANTY OF FITNESS FOR A PARTICULAR PURPOSE.

ISTpure's sole obligation and the buyer's sole remedy for any breach of warranty shall be as set forth above. The buyer agrees that no other remedy (including, but not limited to, incidental or consequential damages for lost profits, lost sales, injury to person or property, or any other incidental or consequential loss) shall be available. Any action for breach of warranty must be brought forward within one (1) year of the date of sale.

ISTpure MAKES NO WARRANTY, AND DISCLAIMS ALL IMPLIED WARRANTIES OF MERCHANTABILITY AND FITNESS FOR A PARTICULAR PURPOSE, IN CONNECTION WITH ACCESSORIES, EQUIPMENT, MATERIALS OR COMPONENTS SOLD BUT NOT MANUFACTURED BY ISTpure. These items sold, but not manufactured by ISTpure (such as electric motors, switches, hose, etc.), are subject to the warranty, if any, of their manufacturer. ISTpure will provide the purchaser with reasonable assistance in making any claim for breach of these warranties.

LIMITATION OF LIABILITY

In no event will ISTpure be liable for indirect, incidental, special or consequential damages resulting from ISTpure supplying equipment hereunder, or the furnishing, performance, or use of any products or other goods sold hereto, whether due to a breach of contract, breach of warranty, the negligence of ISTpure, or otherwise.

Report all accidents or "near misses" which involve ISTpure products to :

- Technical Assistance

The following items are not covered under the ISTpure warranty policy :

- Parts or chassis replacement due to normal wears.

Report all accidents or negligence involving ISTpure products to our Service Department :

1 877 629-8202



SOLVENT RECYCLER SPECIFICATIONS

SPECIFICATIONS	SR 30		SR 60	
Units system	Imperial	Metric	Imperial	Metric
Geometrical capacity of boiler	9 US gal	35 L	18 US gal	67 L
Useful capacity of boiler	8 USgal	30 L	16 US gal	60 L
Operating temperature	104°-360°F	40°-180°C	104°-360°F	40°-180°C
Solvent protection	Class 1, Div. 1, Group D			
Solvent temperature	class 310 °C			
Absolute operating pressure	223 - 1,000 hPa			
	170 -760 mmHg			
	-0.223 - 1 bar			
Relative operating pressure	-776 - 0 hPa			
	-590 - 0 mmHg			
	-0.776 - 0 bar			
Time per cycle of distillation	3.5 to 4.5 hours (estimate)			
Yield	85% – 97%			
Cooling system	Motor Fan 1/8 hp		Motor Fan 1/2 hp	
Boiler material	Stainless steel AISI 304			
Cover material	Stainless steel AISI 304			
Condenser material	Copper (standard) / Stainless steel (optional)			
Voltage	240 V – 1 Ph – 60 Hz			
Power consumption	2 500 W		5 000 W	
Nominal amperage (240V)	11 A		24 A	
Thermic oil capacity	2.7 gal	10 L	5.3 gal	20 L
Dimensions (LxWxH)	26" x 26" x 62"	mm : 650x 650 x 1550	30" x 32" x 76"	mm : 750x 800 x 1900
Weight	350 lb	159 kg	578 lb	263 kg
Warranty	12 months standard. Warranty additional 12 months extension with returned warranty card on parts only.			



SAFETY AND WARNINGS

GENERAL SAFETY

1. Carefully inspect the shipping crate for any signs of transport damage. The damage to the create often indicates possibility of transport damage to the equipment inside.
2. Carefully remove your ISTpure Recycler Cabinet from the shipping crate.
3. Check your equipment immediately to ensure that it is free of transport damage. Report any transport damage to the carrier without delay for possible claim procedures. ISTpure is not responsible for damage to equipment after it leaves our warehouse.
4. Check the equipment list and compare it with the parts you have received. If any parts are missing, contact the supplier you purchased the equipment from.

Before operating the ISTpure recycler, read this instruction manual completely. All ISTpure products are engineered and manufactured to the highest performance standards and have been subjected to detail testing before shipment from the factory.

DANGER AND WARNING LABELS

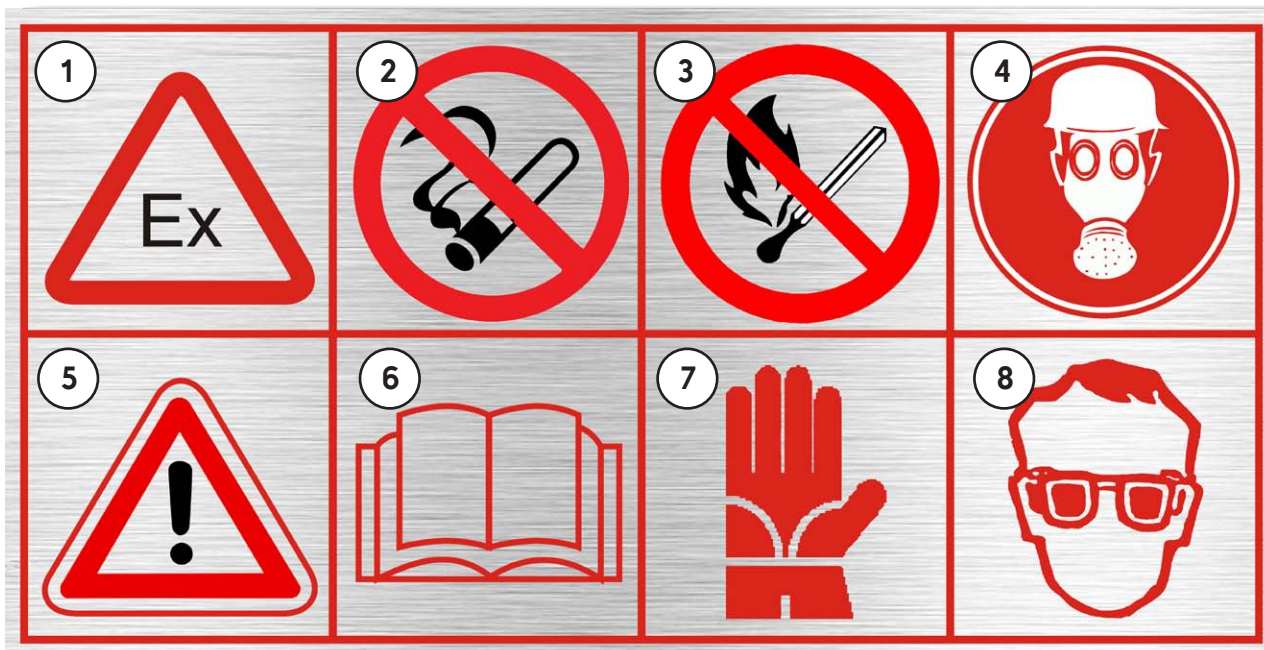

1. Presence of flammable vapors and solvents
2. No smoking or metal grinding nearby
3. Keep away from open flames
4. Wear breathing mask
5. Observe warnings at all times.
6. Read the Instruction Manual carefully.
7. Wear solvent-proof rubber gloves.
8. Wear protective eyewear before use.



SAFETY AND WARNINGS (CONT'D)

WARNING

« READ ALL INSTRUCTIONS » Failure to follow the **SAFETY RULES** identified by a **BULLET (•)** symbol listed **BELOW** and other safety precautions may result in serious personal injury.

“ SAVE THESE INSTRUCTIONS “

GENERAL SAFETY RULES

- **KEEP WORK AREA CLEAN.**
- **KEEP CHILDREN AWAY.** Do not let visitors come in contact with the equipment. All visitors should be kept away from the work area.

PERSONAL SAFETY

- **DRESS PROPERLY.** Do not wear loose clothing or jewelry. They can be caught in the moving parts. Wear protective hair covering to contain long hair.
- **USE SAFETY EQUIPMENT. WEAR SAFETY GOGGLES** or glasses with side shields and breaking mask.
- **STAY ALERT. USE YOUR COMMON SENSE.** Concentrate on what you are doing. Do not operate the unit when you are tired or under the influence of drugs or alcohols.
- **DO NOT OVERREACH.** Keep proper footing and balance at all times.

UNIT USE AND CARE

- **DO NOT FORCE THE UNIT.** It will perform better and safer at the rate for which it was designed.
- **THE USE OF ANY OTHER ACCESSORIES** not specified in this manual may create a hazard.
- **CLOSE THE MAIN AIR SUPPLY VALVE AND MAIN POWER DISCONNECT BEFORE SERVICING** or when not in use.
- **DO NOT ALTER OR MISUSE THE UNIT.** These units are precision built. Any alteration or modification not specified is misuse and may result in a dangerous situation.
- Only trained repairmen should attempt (•) **ALL REPAIRS**, electrical or mechanical. Contact the nearest ISTpure repair service facility. Use only ISTpure replacement parts, any other parts may create a hazard.



SAFETY RULES (CONT'D)

THE OPERATOR MUST WEAR protective water-proof rubber gloves to prevent contact between his hands and the products used for cleaning.



THE OPERATOR MUST WEAR protective eyewear to prevent spatte from coming in contact with his eyes.

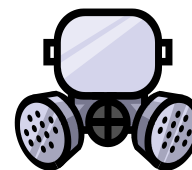

STAY ALERT at the start of the wash cycle. Make sure the liquid solution is not «corrosive» or flammable. Immediately stop the using and replace the solvent whenever you note signs of corrosion on the unit.

IF EYES COME IN CONTACT WITH SOLVENTS rinse thoroughly with water.

BEFORE USING the Solvent Recycler, make sure that all safety devices are in perfect operating condition.

BECOME FAMILIAR WITH THE CONTROLS and their functions before commencing work.

BE CAREFUL when you load or unload the solvent in the unit. Make sure you do not splash or spill the contents on the workshop floor.

THE OPERATOR MUST PERIODICALLY check the level of the solvent contained in the equipment to be sure to not run this pump dry.

DO NOT USE ELECTRICAL OR PNEUMATICAL TOOLS WITH THE UNIT. AVOID GASEOUS AREAS. Do not operate portable electric tools in explosive atmospheres in the presence of flammable liquids or gases. Motors in these tools normally spark, and do not scrape or scratch the machine with metal objects; the sparks might ignite fumes.

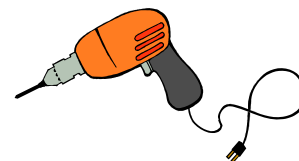

DO NOT ALLOW FAMILIARITY GAINED FROM FREQUENT USE OF YOUR RECYCLER TO BECOME COMPLACENT. Always remember that a careless fraction of a second is sufficient to inflict severe injury.

DO NOT ALTER OR MISUSE THE UNIT. Any alteration or modifications is a misuse and may result in serious personal injuries.



SAFETY RULES (END)

COMPLY WITH LAWS IN THE COUNTRY where the washer is installed regarding the use and disposal of the products used to wash clean objects.

FIRE EXTINGUISHING SYSTEMS must be installed in the same room or close to the unit in case of emergency.

These appliances must be well maintained and inspected every year by qualified personnel.



THE INSTALLATION SITE MUST PERMIT PERSONNEL TO EASILY AND QUICKLY MOVE AWAY FROM DANGER ZONES IN CASE OF AN EMERGENCY.



DO NOT USE THE UNIT TO wash or degrease objects designed to come in contact with food.

COMPLY WITH LAWS IN THE COUNTRY where the Solvent Recycler is installed regarding the use and disposal of the products used to wash clean objects.

DO NOT USE UNSTABLE REACTIVE
avoid distilling solvent that may include unstable reactives, such a nitrocellulose.



THINK SAFETY! SAFETY IS A COMBINATION OF THE OPERATOR'S COMMON SENSE, KNOWLEDGE OF THE SAFETY AND OPERATING INSTRUCTIONS AND ALERTNESS AT ALL TIMES WHEN THE UNIT IS BEING USED.



DISTILLATION OPERATING PRINCIPLES

This PLC controlled solvent recycler, will recycle many different types of solvents that have been contaminated by paints, pigments, inks, greases, oils, etc. Through the simple distillation process, the recycler separates the contaminants from the original solvent.

The boiling of the polluted solvents consists of a boiler surrounded by a reservoir containing thermal oil, heated by an electrical resistance. The solvent vapors produced in the boiler are eventually conveyed in an solvent cooled drum and then brought back to their liquid state. The cooled solvent is gathered in a clean stainless steel collecting tank, ready to be re-used again. The process does not alter the characteristics of the distilled solvent. Consequently, the operation can be performed endlessly.

The residues remains inside the boiler and can be unloaded when cold. It is recommended to use a liner bag (Part# 300006) for SR 30, (#300019) for SR 60, for information contact the authorized reseller) to be placed inside the boiler. These bags facilitate the unloading of residues at the end of the distillation cycle.

The cycle is completely automatic. The operator only has to close the lid, touch the **START** button and remove the residues at the end of the cycle.

In case of malfunction, abnormal increase of temperature or power failure, the cycle is automatically **STOPPED** and the recycler **CANNOT** be re-started until the problem has been resolved.

OBJECTIVES

The goals that can be achieved with ISTpure distillation units are :

1. Solvent recycling with the highest yield possible.
2. Obtaining «special» and not «toxic and noxious» residues.
3. Reducing intervention times and operator discomforts.

Solvent and contamination product topologies are so different that there are no general rules that can apply for all cases. This manual will provide general information that may be useful to your specific situation to which you can adapt as you gain more experience and comfort with using the distillation units.



The products to be recycled normally consist of :

Solvent or Reducer + Contaminated Products

- **Solvent**

« Solvent » defines the liquid, which, without reacting chemically, dissolves other substances (solutes), forming a solution.

As every solvent has its own boiling temperature, we must (in order to distill the solvents) set the thermostat at a higher working temperature of about 10°C to 50°C (30°F to 80°F) than the boiling point.

- **Reducer**

A mixture of solvent is defined as a « reducer ».

As every solvent component in the mixture has its own boiling temperature, in order to proceed to the distillation of a reducer, set the thermostat at a working temperature of about 10°C to 50°C (30°F to 80°F) higher than the boiling point of the most high-boiling solvent.



OBJECTIVES (CONT'D)

- **Chlorinated Solvents (these solvents can be recycled with the SR30V–SR60V–SR120V or SR180V only)**

Chlorinated Solvents are **non-flammable solvents**, generally utilized for cleaning and degreasing metal surfaces. Normally, these types of solvents are polluted by **oil, grease**, etc.

Atmospheric pressure distillation of chlorinated solvents will result in a partial recovery, leaving a distillation residue containing about 20% of solvents. This occurs when the oil contents in the boiling solution increases; therefore the mixture distillation temperature rises.

These solvents are thermalable, meaning that when they exceed their specific critical temperature they decompose causing the formation of hydrochloric acid. This acidifies the product and therefore cannot be reused. When operating with atmospheric pressure, and reaching this critical temperature, we shall have distilled only 80% of the solvent.

Operating with a vacuum will allow you to achieve a yield of 100%, as you do not reach the critical temperature (vacuum kit is optional).

- **Liquid Polluting Products**

The most common liquid contamination products are :

Oil, Ink and Water

The presence of liquid contamination may (in the distillation phase) drag contaminants into the clean product, leaving traces in the distillate.

For different types of oil and ink with particularly high boiling temperature, this problem normally does not occur and the process of separation may be obtained with a simple distillation.

If there is « **water** » in the contaminated product, you **must recycle** with a **fractional distillation**. This operation is not possible with a simple distillation process.

Unloading a liquid polluting product from the recycler presents no problem. It is possible to obtain a complete separation of the polluting product from the reducer.

This complete separation is not possible when **Chlorinated Solvents** are to be distilled under atmospheric pressure.

For these solvents it is necessary to proceed with a « **vacuum** » distillation. This process allows you to obtain a residue without solvent.

- **Solid Polluting Products**

The most common solid polluting products are :

Resins, Pigments, Paints, Polymers, Glue, Powder, Grease, etc.

Solid polluting products, according to their nature, already classified as «toxic and noxious» have the advantage (in comparison to liquid contamination products). They can be unloaded into controlled waste dumps, as they do not release toxic substances into the ground. However, this is on the condition that the percentage of solvent will not exceed that of the Concentration Limit (CL) – a value legally stabilized for different types of solvents used in different Countries.

By distillation, and this is another considerable advantage, you can obtain an extremely pure distilled product as there will be no contaminants dragged into the distilled product.

The disadvantage, in comparison with liquid polluting products, is a greater difficulty in cleaning the distillation unit.

Leave a minimal percentage of solvent (3-10%) with the contaminants in the solution of residue, in order to obtain a semi-solid residue, and therefore will be easily discharged.

These percentages, however, are greater than the Concentration Limit (CL) accepted for the disposal in controlled dumps.



WARNINGS

The operating staff must be fully instructed on the use and function of the unit as well as on the correct application of the protection devices. The instructions must be repeated in regular intervals.

It is essential to keep the Instruction Manual inside the door slot or close to the unit.

Operator must wear anti-static clothes, avoiding clothes made of synthetic material (nylon, rayon, etc.).

Open the cover only after the unit has cooled down, with the control board indicating less than 100°C (212°F).

When unloading residues, it is recommended to use solvent resistant gloves and an anti-vapor mask.

Do not use any metallic tools as they could provoke sparks.

The unit must undergo a revision and control according to its grade of use. Maintenance must be carried out by qualified personnel and according to the indications of the Manufacturer.

It is important to pay attention to the control of the security installations: thermostats, flow controls, thermocouple detectors, switches of safety levels, aspirators, etc.

Before using a distillation unit, which has been out of use for a long time, it must be checked and brought back into optimal condition in order to guarantee the operator's security at all times.

According to the type of liquid to be distilled and the kind of operation to be performed, it is important to adopt adequate personal protection rules.

If you are not using plastic bags, the residues must be cleaned with tools that do not provoke sparks.

The cover works as a safety valve. If you notice steam leaking from the cover, immediately shut down the recycler and consult page 19, « **Troubleshooting** ». In any case, never modify in any way the parts on top of the cover or block the cover in order to avoid the steam from leaking.

Nitrocellulose which is an ester of cellulose and nitric acid is a component found in many lacquers, inks, adhesives and cements cannot be recycled. It automatically **ignites** at 135°-166°C (275°-330°F) and can be extremely volatile.

It is important to clean the boiler thoroughly after each cycle, as a build up of residue will stop the transmission of heat and cause a malfunction.

If repairs are necessary shut off the power supply **IMMEDIATELY**.

Do not smoke, cause sparks or use open flames near the recycler.

This unit is for use in a 40°C (104°F) environment with no forced ventilation. Under these conditions, the unit shall be spaced a minimum space according to national regulation from potential sources of ignition such as electrical receptacles, switches, pilot light fixtures, contacts and other similar equipment that can produce sparks. If the equipment is used in higher ambient temperatures an increase in spacing from sources of ignition shall be considered.

This unit has been tested for use with the solvents indicated in the instruction manual (see tables on pages 22-23, « **Flammable Solvents and Non-Flammable Chlorinated Solvents** »).



ENVIRONMENTAL PROTECTION

The user must ensure the protection of the environment so that the recycler can not be the cause of vapor emissions or odors. The use must ensure that the residues are treated and disposed of according to local standards.

INSTALLATION

If the unit is installed in a small closed room like 10' x 10' than it has sufficient natural or artificial air ventilation. If installed in explosion proof room or mixing room for paint ink, there is no need to add additional ventilation.

Places and zones with sufficient artificial air ventilation are those with such ventilation capacity as to change air circulation ten times per hour. The outlet of the unloading air channels must be placed in a way that the evacuation of emerging vapors does not cause any form of danger.

Complete air circulation should be provided in case of artificial air ventilation.

Air ventilators or their motors should be explosion proof.

Make sure that the emergency exit is easily accessible.

The distillation unit must be positioned near one door that leads to an exit door.

Place a fire extinguisher near the unit (for fire type B and C).

Keep a distance of at least 24 inches between the unit and any object to allow the recycler to cool off, and be able to perform the maintenance if necessary.

Place the unit on a flat surface away from heat, sparks and any source of flames.

Connect permanently the unit to an efficient grounding pole.

Place a container of at least twice the capacity of the boiler:

- 16 gallons or more for the SR30
- 32 Gallons or more for the SR60.

The power outlet is located on the back of the unit.

- The SR30 unit should be permanently connected into a 240 V single phase, 15 A explosion proof electrical line.
- The SR60 unit should be permanently connected into a 240 V single phase, 30 A explosion proof electrical line.

When service or maintenance work is required, disconnect the main breaker switch before servicing or for maintenance work.

Note : If the unit is equipped with the Sludge Monitoring Safety Device, make sure to use an inline filter on your water supply to trap debris upstream from the valve.



ELECTRICAL CONNECTIONS

The Class 1 Division 1 electrical connections must be performed by a certified electrician.

For the current and voltage specifications, refer to the nameplate on the right side panel.

It is recommended to locate the above-mentioned electrical box, at a height of 5 to 6 feet from the floor.

N.B. : An adequate explosion installation must be provided for the solvent recycler and all other components around (for example: protection type Class 1, Div. 1, Group D, with increased safety).

Once the electrical connections are complete, open the main breaker for the recycler and the keyboard light will be « **ON** ».

Each time the power is closed and re-opened, the ISTpure electronic keyboard will enter a self-test mode. During 5 seconds, all 5 lights and all 5 digits of 7 segment lights will stay on. Then the keyboard will display its own programming version (example: r 6.0) for a few seconds and then the thermometer light will stay « **ON** » and the actual temperature of the thermic oil will be displayed.

The control board is « **READY** » for instructions.

DATA & SPECIFICATIONS						
Electrical Requirements Amp Draw listed for entire unit — including motor and heating element						
MODEL	Full load Amp Draw			Location		
	220V	480V	600V	Non-classified area	In mix room/classified area	
SR 30	11.7	—	—	<ul style="list-style-type: none"> ● General purpose disconnect ● Min. 5 ft away from unit ● Min 18" off the floor 	Explosion proof disconnect required	
SR 60	23.4	—	—			
SR 120	—	14.5	11.3			
SR 180	—	20.8	15.0			
SR 240	—	24.8	19.5			
Air Requirements						
ITEM	Air Line Specifications	cfm	Notes			
SR30V-60V	3/8" @ 100 psi	5	Factory set at 85-90 psi			
SR120V-180V	1/2" @ 100 psi	10				
SR120V-180V	1/2" @ 100 psi	10				
SR 240	1/2" @ 100 psi	10				
Thermal Heat Transfer Oil						
Model	Oil Capacity	Parts Number				
SR30 TO SR240	Please refer to your product identification plate for required oil volume. 	Standard	High Temp.	Volume		
		330066	330166	1 gal / 4 L		
		330067	330167	2.5 gal / 9.5L		
		330068	330168	5 gal / 19 L		
		330069	330169	55 gal / 208L		
Recycler Bags						
MODEL	Part number					
SR 30	300006					
SR 60	300019					
SR 120	300008					
SR 180	300009					
SR 240	300010					
INFORMATION CODES						
ISTpure offers a complete line of spray gun cleaners and solvents recyclers that conform to the requirements of :						
<ul style="list-style-type: none"> • NFPA-33 Standard for spray application using flammable and combustible materials. • NFPA-30 flammable and combustible liquid code • IFC : International Fire Code 						
The recycler has been certified and listed :						
<ul style="list-style-type: none"> • UL 2208 standard for solvent distillation unit 						
The recycler has been reviewed and approved by :						
<ul style="list-style-type: none"> • QPS for U.S. & Canada requirements report #LR1558 						
Conformity of all these requirements is dependent upon the manner in which the equipment is installed. The contractor will make certain that all of the electrical wiring and conduit, piping, gas supply, roof penetrations, automatic fire protection systems, and the location of the equipment within the building also conforms to the cited codes and the other references.						
EXCLUSIVE RIGHTS This drawing is the exclusive property of ISTpure and informations contained herein can be used only when specifically authorized by ISTpure. Possession of this drawing does not authorize use nor transmission to any other organisation.			<h2 style="margin: 0;">GENERAL ARRANGEMENT</h2>			



INSTALLATION DRAWINGS

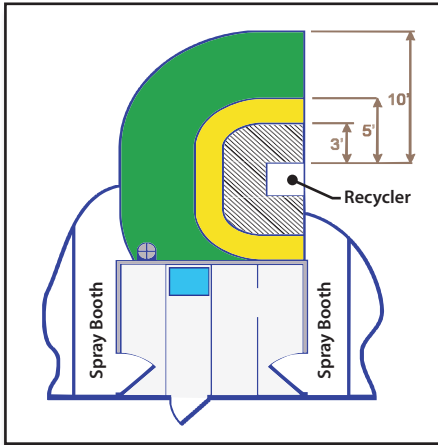

INTERMEDIATE MIX ROOM

LEGEND

-  Class 1 - Div 1
-  Class 1 - Div 2
-  Class 1 - Div 2
18" Height only

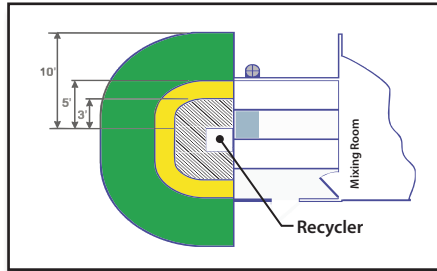

THREE SIDES MIX ROOM

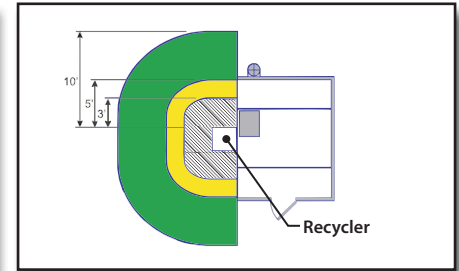

FREE STANDING MIX ROOM

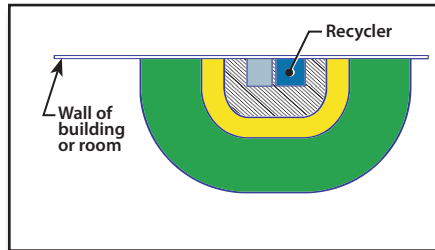

**ENTIRE SYSTEM OUTSIDE
MIX ROOM**

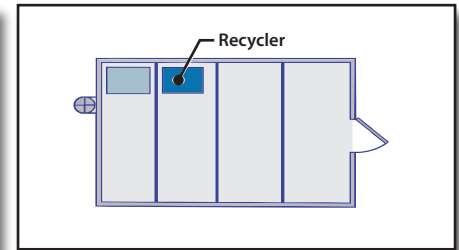

**ENTIRE SYSTEM INSIDE
MIX ROOM**

Classification zones as per :

- A) NFPA 33 standard for spray application using flammable and combustible materials, sections 4.3.5
 - B) International fire code, chapter 34 flammable and combustible liquids 3403.1.1
- Zone requirements apply to both gun cleaners and recyclers together and stand alone.

EXCLUSIVE RIGHTS

This drawing is the exclusive property of ISTpure and informations contained herein can be used only when specifically authorized by ISTpure. Possession of this drawing does not authorize use nor transmission to any other organisation.

GENERAL ARRANGEMENT

ISTpure
346 Allée du Golf, St-Eustache (Qc) J7R 0M8 Canada
Tel 1 800 361-1185 • 450 963-4400 Fax 450 963-5122



KEYBOARD OPERATIONS

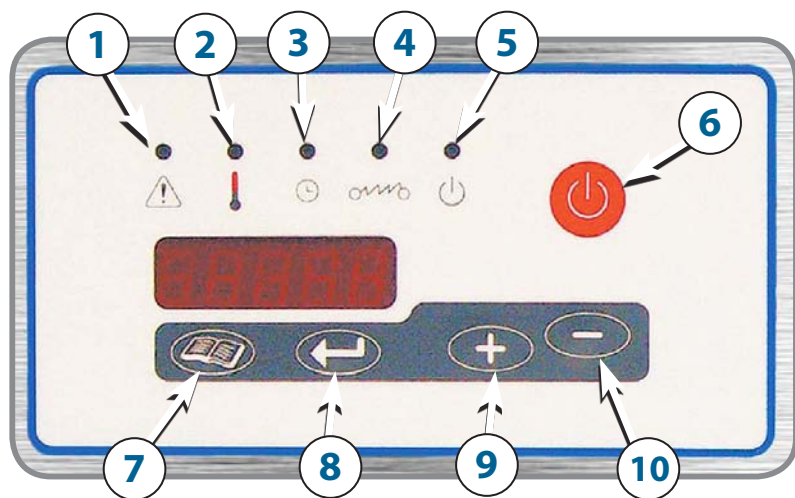

Keyboard Symbols :

1. Alarme
2. Temperature
3. Time
4. Electric Heater
5. Start/Stop (light)
6. Start/stop (button)
7. Menu
8. Enter
9. Increase
10. Decrease

The ISTpure temperature control board has been designed to control the different cycles during the distillation process. It controls the temperature of the thermic oil, vapors and the distillate solvent coming out of the condenser. It uses this information to maintain a constant temperature, starts the cooling fan to cool the vapors coming off the condenser and stops the cycle if necessary.

Two heat sensors are used to read different temperatures. The thermic oil and the distillate solvent temperatures are captured using two thermocouples (because of high temperatures rising up to 175°C (343°F)). These sensors assure precision of the readings of the temperatures of $\pm 1^{\circ}\text{C}$ ($\pm 2^{\circ}\text{F}$).

The ISTpure board also display the total number of hours of operation of the recycler. **For every 2000 (two thousand) hours of operation, the display code «OIL» will appear to remind you that it is time to replace the thermic oil follow the steps on page 23 to 25.** The code «OIL» will remain displayed for ten (10) hours and then will disappear.

The display board consists of 5 digits of 7 segments, of 5 independent LEDs and of 5 touch-tone keys (7, 8, 9, 10 and 11) to operate the recycler. The operator can program the temperature, select the amount of time for the cycle, start or stop the cycle, choose between Celsius or Fahrenheit degrees, and if necessary, display every code to verify the operation of the recycler in case of problems.











The safety devices will stop the cycle in case one of the sensors detects any trouble. The **TROUBLE** light will be displayed. The recycler **CANNOT** be re-started until the problem has been resolved.

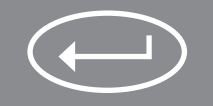
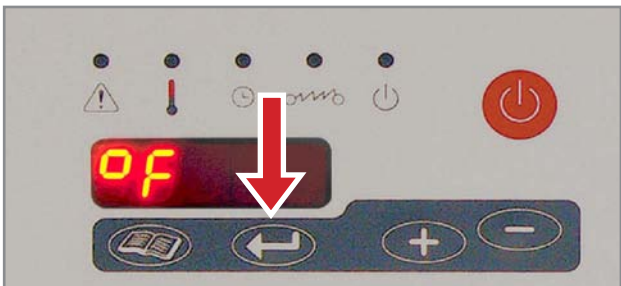

KEYBOARD OPERATIONS (CONT'D)

CONVERTING BETWEEN CELSIUS AND FAHRENHEIT MODE.

All units manufactured by ISTpure are programmed in CELSIUS.

Press	Indication	Result of the keyboard
	<p>Step 1 – Press + </p> <p>Press and hold the Plus sign for 7 seconds</p>	
	<p>Step 2 – Press - </p> <p>Press and hold the Minus sign once</p>	
	<p>Step 3 – Press the Arrow</p> <p>Confirm by pressing the arrow sign you are now in Fahrenheit</p>	
 	<p>Now set up time and temperature (see page 21)</p>	



STARTING PROCEDURES

1. Preparation

- Position a clean solvent container (equal the capacity or greater than the boiler) on the left end side where the clear tube comes from the outlet of the condenser.
- The clean solvent container must have an air vent to allow normal fill-up.
- You must use a metallic container, and it must be connected to the ground clip supplied with the unit.

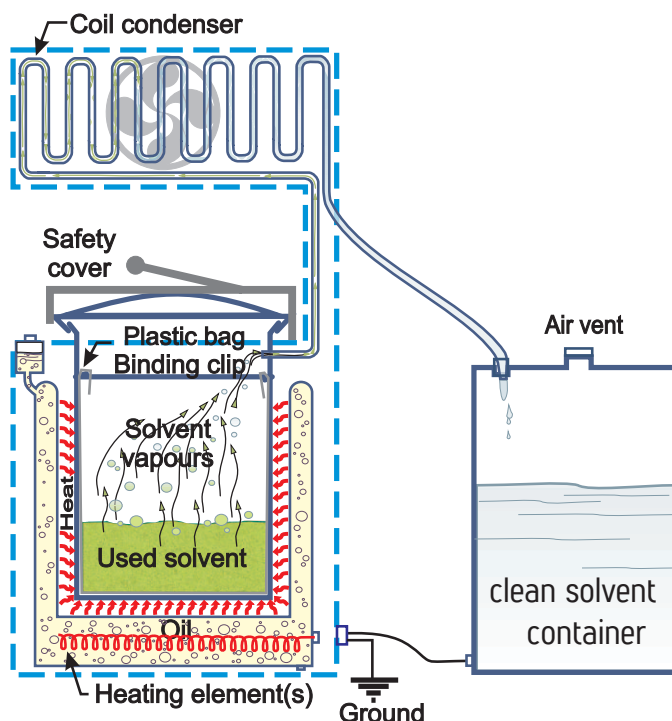

2. Plastic bag installation steps

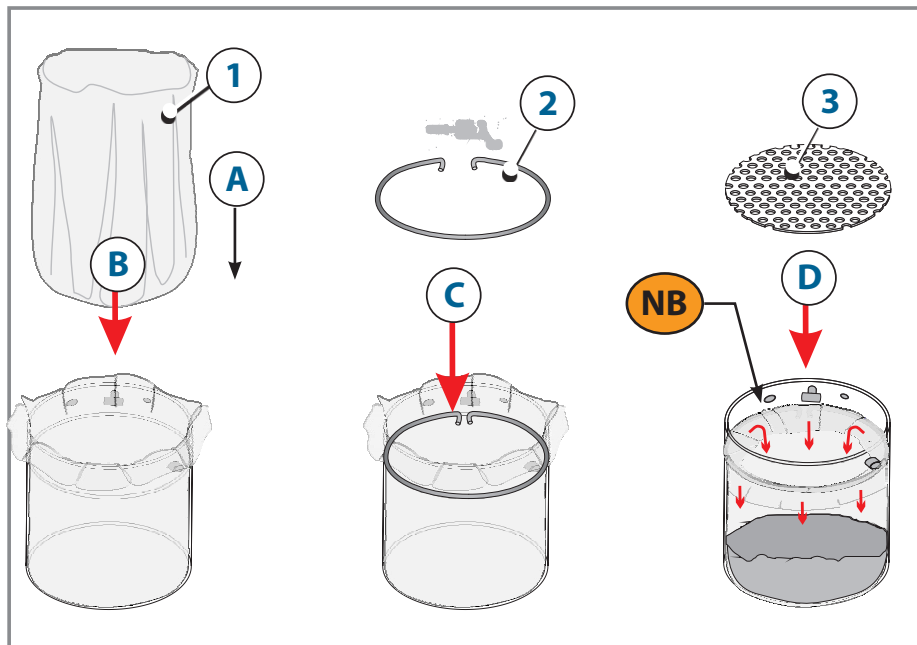

- Pull the bottom corner of the bag inwards.
 - Insert the plastic bag (#1) in the boiler. **SR30 : # 300002**
SR60 : #300018
 - Insert the retaining ring (#2) **SR30 : # 323113**
SR60 : #323122 and insert the locking mechanism.
 - Optional antifoam grate (#3), **SR30 : #324022**
SR60 : #324026
- NB** Fold the protruding portion of the bags inward as not to cover any spouts.



STARTING PROCEDURES (CONT'D)

Good installation (bag folded)



Wrong installation (Bag above the elbow)



Note : the recycler shown above is a SR30, but the principle is the same for all models.

OVERFLOW PROCEDURE

If the replacement bag were to block any of the spouts found inside the boiler chamber this would create an unsafe pressure build up. A safety mechanism built into the lid would release the excess pressure and lead to a dangerous situation in which a nearby operator could be burned.

Should you experience this situation, ensure to turn off the cycle switch if safe to do so. If unable to turn off the cycle close the main circuit break and stay away from any solvent which may splash out of the recycler.



Important: Wait at least 1 hour before opening the unit and put on gloves and a protective mask before approaching the boiler.



STARTING PROCEDURES (END)

3. Filling up the Recycler

- A. Open the cover and manually fill the boiler with dirty solvents up to approximately 1 inch (25 mm) below the grooved slot mark indicating the maximum level.
- B. Before closing the cover, verify the condition of the lid gasket. **It is recommended to change the oil for SR30 (330067 – 10 liter container), for SR60 (330068 – 20 liter container) & the cover seal for SR30 (304018) for SR60 (304023), SR60 with vacuum (304024) every 2000 hours of work or every year whichever comes first. See page 28 for oil change procedures.** Both SR120 and SR180 models use the same orange or black gasket cover seals.
- C. according to the type of solvent to be distilled, you must use the proper cover gasket. See part numbers below :

Part # 304018 (8 Gal. / 30 Liters)	Gasket Orange Color	
Part # 304023 (15 Gal. / 60 Liters)	Gasket Orange Color	
Part # 304024 (15 Gal. / 60 Liters)	Gasket Black Color	

Using a **non-suitable gasket will cause vapors to leak from the cover.**

During the boiling phase, some solvents can foam up and lead to a decrease in the quality and quantity of solvent that can be recovered. To avoid this situation an optional anti-foam kit (part# 324022 for model SR30V or 324026 for model SR60V) is available.

Pay the utmost attention while the residues are drying. Some polluting products tend to carbonize with a considerable discharge of smoke from the recycler.

In case this occurs, press the (START / STOP) button to end the cycle.

In this case it is not possible to dry the residues at atmospheric pressure; proceeding to the vacuum distillation phase may solve the problem. This technique allows you to operate at a much lower temperature.

Opening the cover before the distillation cycle is complete will cause the gasket to swell. You must wait at least **one hour**.

- D. Close and secure the cover properly. Your cover acts as a safety valve. **NEVER** modify the cover mechanism and **NEVER** use any tools to tighten the cover.
- E. **DO NOT SHAKE OR TILT** the load recycler during operation.

NOTE : All ISTpure recyclers are pre-tested and are shipped with thermic oil in it and are ready to be used.

TEMPERATURE AND CYCLE TIME SELECTION









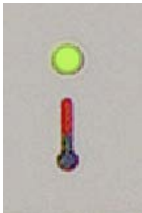
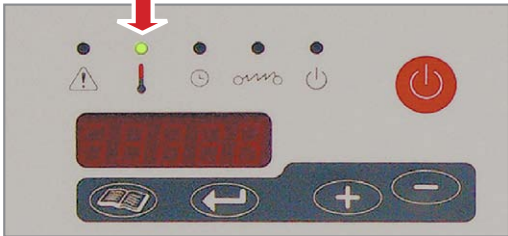

Before starting the cycle, you must select between **CELSIUS** and **FAHRENHEIT** temperatures (see p.17). Temperature settings are determined by the **BOILING POINT** of the solvent to be reclaimed. The boiling points shown are for **NEW SOLVENTS**.

To recycle contaminated solvents, the temperature setting **MUST BE** 10°C to 50°C (50°F to 122°F) **MORE** than the stated boiling points starting with 10°C/30°F for the first batch increasing by until 50°C /122°F proper setting is obtain.

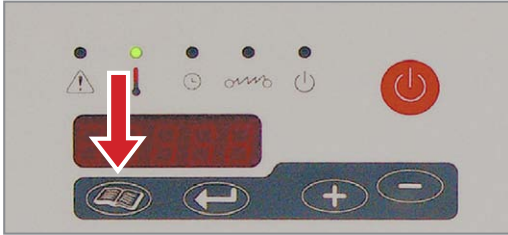
NOTE : The temperature setting starting point will vary according to the solvent used and the percentage of contaminants in the solvent.



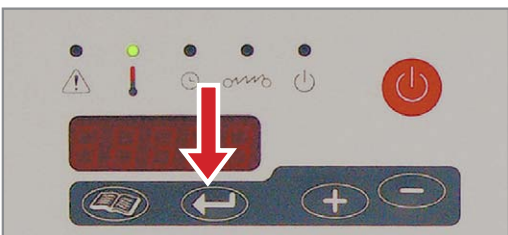
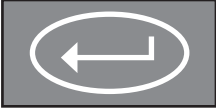
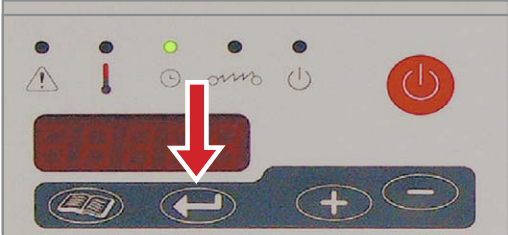

TEMPERATURE AND CYCLE TIME SELECTION (CONT'D)

Press	Indication	Result of the keyboard
	<p>Thermometer light is ON.</p> <p>Keyboard will display the actual temperature of the thermic oil.</p>	
	<p>Thermometer light flashes.</p> <p>You have the option to select the temperature for the cycle by pressing keys.</p> <p> or </p>	
	<p>You have the option to select your own amount of time for the cycle by pressing keys :</p> <p> or </p> <p>Recycler will automatically stop when time has expired.</p>	
	<p>Clock light is ON.</p> <p>The total amount of working hours of the recycler since day one will be displayed.</p> <p>This cannot be changed.</p> <p>For every 2,000 hours of operation the message OIL will flash to notify you to change the thermic oil.</p>	
	<p>Thermometer light is ON.</p> <p>Keyboard will display the actual temperature of the thermic oil.</p>	



STARTING PROCEDURES

Press	Indication	Result of the keyboard
	<p>Press the START/STOP key. ON light will go on.</p> <p>Electric element will start heating the thermic oil.</p> <p>Element light will go on.</p>	

DURING THE DISTILLATION CYCLE

- A. Every 5 seconds, the keyboard will display 3 different readings:
 1. Selected boiling temperature : (Thermometer light will flash).
 2. Amount of time selected for that cycle : (Clock light will flash).
 3. Elapsed time since starting the unit : Clock light will be on).
- B. The cooling fan will start turning.
- C. The recycled solvents will start dripping approximately one hour after the start-up.
- D. At the end of the cycle, the **ON** light will flash and a count down timer will indicate the remaining time left in the cool down period (starting at 60 minutes and counting down to zero).. During the cool down time the heating element will be off but the cooling fan will remain on during the cooling period. When the cycle time has ended, the display panel will indicate **-END-**.
- E. The cooling fan will automatically shut off at the end of the cooling cycle.

END OF CYCLE

- The keyboard will display the total elapsed time for that cycle.
- All lights will shut off except the ON light.
- Wait at least one hour before opening the cover.
- You can now remove the residues.
- Press the stop key.





FLAMMABLE SOLVENTS
(vacuum system not required)

SOLVENT TYPE	Distillation Temperature		Temperature Class	Ignition Temperature		Seal Silicone	Condenser Type	
	°C	°F		°C	°F		cop	s/st
Acetone	56	133	T2	535	995	A	A	A
Alcohol Amyl	145	293	T2			A		B
Alcohol Butyl	118	244	T2			A	A	A
Alcohol Ethyl	79	175	T2	362		A	A	A
Amyl Acetate	126-155	259-311	T2	375	707	A	A	A
Benzol (Benzene)	80	176	T-1	498	1040	A	B	B
Butanol (Butyl Alcohol)	118	244	T2	366	691	A	A	A
Butyl Acetate	128	262	T-2	370	698	A	B	A
Cabinol	65	149	T-2	385	725	A	B	A
Cellosolve Acetate	156	313	T-2	377	711	A	B	A
Cyclohexanone	155	311	T-2	419	786	A	B	A
Ethyl Acetate	79	174	T-2	427	801	A	A	A
Ethyl Alcohol (Ethanol)	79	175	T-2			A	A	A
Ethyl Benzene	136	277	T-1	466	871	A	A	A
Ethyl Glycol Acetate	156	313	T-2	377	711	A	A	A
Iso Amyl Acetate	125-155	257-311	T-2	375	707	A		A
Iso Butyl Acetate	104-119	219-246	T-2	420	788	A		
Iso Butyl Alcohol	111	232	T-2	430	806	A		
Iso Propane	83	181	T-2	400	752	A	B	A
Iso Propyl Acetate	89	192	T-2	460	860	A	A	A
Iso Propyl Alcohol	83	181	T-2	400	752	A		A
Iso Propyl Glycol	143	289	T-2	345	653	A		
Lacquer Solvents	140	284	T2	535	995	A	A	A
Methyl Acetate	58	136	T-2	454	850	A	B	A
Methyl Cellosolve Acetate	156	313	T-2	377	711	A	B	A
Methyl Ethyl Ketone (M.E.K.)	80	176	T-1	530	986	A	A	A
Methyl Glycol Acetate	137-152	278-305	T-2	380	716	A	A	A
Methyl Isobutyl Ketone (M.I.B.K.)	117	243	T-1	459	858	A	B	A
N. Butyl	118	244	T2	366	691	A		A
Pentanol	138	280	T2	327	621	A		A
Propanol	98	208	T2	371	700	A		A
Propyl Alcohol	98	208	T2	371	700	A	A	A
Propyle Acetate	101	214	T2	450	850	A	A	A
Paint Thinner	140	284	T2	535	995	A	B	B
Sec. Butyl Alcohol	101	214	T2	390	734	A		A
Toluol	110	231	T1	480	905	A	A	A

FLAMMABLE SOLVENTS
(vacuum system required)

SOLVENT TYPE	Distillation Temperature		Temperature Class	Ignition Temperature		Seal Teflon braided	Condenser Type	
	°C	°F		°C	°F		cop	s/st
Aliphatic hydrocarbons		370			487	A	A	A
Bottcherin		370			487	A	A	A
Citrus terpenes	176	349		237	458	A	A	A



FLAMMABLE SOLVENTS (CONT'D)

(vacuum system required)

SOLVENT TYPE	Distillation Temperature		Temperature Class	Ignition Temperature		Seal Teflon braided	Condenser Type	
	°C	°F		°C	°F		cop	s/st
D Limonene	176	349		237	458	A	A	A
Dimethylformamide (DMF)	153	307	T-2	445	833	A	A	A
Ether Glycol	210			277		A	A	A
LO NX (Kodak)	203	398		N/A	N/A	A	A	A
N-Methylpyrrolidone	202	396		N/A	N/A	A	A	A
White Spirit	150-175	302-374	T-2	353	489	A	A	A
Varsol	150	302	T-2	351	487	A	A	A
Virosol 225				N/A	N/A	A	A	A
Xylol (Xylene)	144	291	T-1	463	907	A	A	B

NON - FLAMMABLE CHLORINATED SOLVENTS

(vacuum system required)

SOLVENT TYPE	Distillation Temperature		Temperature Class	Ignition Temperature		Seal Silicone	Condenser Type	
	°C	°F		°C	°F		cop	s/st
1,1,1. Trichloroethane-(Methyl Chloroform)	74	165				A		A
n-Propyl Chloride	47	117				A		A
Isopropyl chloride	40	104				A		A
Methylene chloride	40	106				A		A
Dichloroethylene	37	99				A		B
Ethylene dichloride	84	183				A		A
Monochlorobenzene	133	273				A		A
Propylene dichloride	98	208				A		A
Chloroform	61	142				A		A
Trichloroethylene	92	198				A		A
Trichloroethane	115	239				A		A
Ortho dichlorobenzene	182	361				A		A
1,2,3. trichloropropane	158	317				A		A
Carbon tetrachloride	78	172				A		A
Perchloroethylene	122	254				A		A
Tetrachloroethane	147	297				A		A



WARNING



The information and data set forth in this catalog or the information disclosed by a representative is for your general information only. Many factors influence the resistance of materials to corrosion, such as temperature, concentration, aeration and contaminants.

A – Recommended

B – Not Recommended

Blank – Information not available



TROUBLESHOOTING

KEYBOARD ERROR CODES

There are **5** (five) **ERROR** codes that can be displayed if a problem occurs:

1. **O HI** code indicates that the OIL temperature is too **HIGH**.
2. **L HI** code indicates that the recycled **SOLVENT** temperature is too **HIGH**.
3. **S HI** code indicates that the recycled **SLUDGE** temperature is too **HIGH (OPTIONAL)**.
4. **P-OFF** : water pressure is **LOW** or vacuum negative pressure is **LOW**.
5. **FILL - 0** : **FILL NOT COMPLETED** after 20 minutes.

The **ERROR** code can be erased by touching the + key (9) for each code. Once all the codes have been erased, the display returns to normal and the **ERROR** light disappears.

Distillation at Atmospheric Pressure

Defects	Causes	Remedies
Unit heats but does not distill	Boiler is dirty.	Clean the boiler.
	The solvent boiling point is higher than the temperature indicated on the control panel.	Set a higher temperature on the control panel.
	The solvent boiling temperature is higher than the recycler's highest temperature setting.	Use a solvent with a lower boiling temperature or vacuum distill with the suitable kit (optional).
	Thermic oil is worn out.	Change thermic oil.
	Lack of thermic oil.	Add thermic oil
Smoke comes out from the cover.	Polluting products overheating.	Reduce time and/or working temperature.
	Polluting products decomposing.	Possibly vacuum distill with the suitable kit.
	Dirt on cover gasket.	Clean cover gasket.
Cover gasket swells.	Cover is opened while recycler is hot.	Open the cover one hour after the cycle is complete
	The cover gasket is not suitable for the type of solvent to be distilled	Mount the suitable gasket (see page 26).



TROUBLESHOOTING (CONT'D)

Distillation at Atmospheric Pressure

Defects	Causes	Remedies
Solvent leaks from the gasket.	Worn out gasket.	Replace the gasket.
	Vapor manifold is clogged	Using a funnel, pour in clean solvent, wash vapor tube and blow air into the tube.
	Vapor condenser is clogged.	Replace the condenser.
Unit is in operation mode but does not heat. Indicator light is ON.	Temperature is set at zero.	Increase temperature.
	Burnt out heater.	Change the defective heater
	Mechanical thermostats is defective.	Change the faulty thermostat.
	Thermocouple sensor is defective	Change the faulty thermocouple
Distills only part of the dirty solvent.	Insufficient operating time selected.	Increase the operating time.
	The undistilled fraction has a boiling temperature higher than the temperature set on the control panel.	Set a higher temperature on the control panel.
	Solvent-boiling temperature is higher than the recycler's maximum working temperature.	Convert to a lower boiling solvent or use a vacuum operated unit.
Trouble light flashes and horn signals a problem	Distillate temperature is over 40°C (104°F).	
	Ventilator motor burns out.	Replace the ventilator motor.
	Vapor condenser internally dirty	Clean by compressed air jet.
	Vapor condenser externally scaled.	Wash it, by pouring clean solvent with a funnel into the manifold
	The security thermostat is defective.	Replace the thermostat
Distillate comes out dirty	Loaded with a quantity superior to the maximum.	Load with the exact quantity.
	Solvent foams.	Wait at least 48 hours before beginning a new cycle
	Temperature set on control panel too high.	Reduce working temperature.
	Vapor manifold or condenser dirty.	Wash it by pouring clean solvent with a funnel into the manifold



TROUBLESHOOTING (CONT'D)

Distillation at Atmospheric Pressure

Defects	Causes	Remedies
Distillate assumes a greenish color.	Distilling solvents or reducers in general.	
	The solvent is acidic.	Replace copper condenser with a stainless steel condenser.
Condenser is becoming corroded.	Distilling a chlorinated solvent.	
	Temperature set on the control panel is higher than the temperature indicated.	Set the correct working temperature.
	Solvent acidifies. If the temperature set on the control panel is correct, acidification occurred during process before distillation.	Replace the solvent immediately.
Distillation time is more than 4 hours.	There is a considerable percentage of water in the dirty solvent.	Replace the solvent.
	Lack of thermic oil.	Add thermic oil.
	Thermic oil is worn out.	Change thermic oil.
	Heater is scaled.	Remove thermic oil and clean the heater.
Distills only part of the dirty solvent.	Insufficient operating time selected.	Increase the operating time.
	The undistilled fraction has a boiling temperature higher than the temperature set on the control panel.	Set a higher temperature on the control panel.
	Solvent-boiling temperature is higher than the recycler's maximum working temperature.	Convert to a lower boiling solvent or use a vacuum operated unit.
Trouble light flashes and horn signals a problem	Distillate temperature is over 40°C (104°F).	
	Ventilator motor burns out.	Replace the ventilator motor.
	Vapor condenser internally dirty	Clean by compressed air jet.
	Vapor condenser externally scaled.	Wash it, by pouring clean solvent with a funnel into manifold
	The security thermostat is defective.	Replace the thermostat



TROUBLESHOOTING (END)

Distillation at Atmospheric Pressure

Defects	Causes	Remedies
No vacuum protection	Lack of compressed air.	Adjust the air pressure.
	Lack of compressed air circuit.	Check the connection.
	Distilling a chlorinated solvent.	Turn off the distillate-unloading tap.
	The rubber tube of connection to distillate container is not perfectly connected.	Check the connection towards the condenser and connection on rapid clutch.
	Rubber tube deteriorated.	Change the rubber tube.
	Lack of distillate level control.	Check the connections.
	The cover does not have a perfect seal.	Place the cover correctly on the shoulder of the boiler.
	Cover gasket deteriorated.	Replace the gasket.
	Solenoid defected.	Replace the solenoid.
	Vacuum pump damaged.	Change the vacuum pump.
During the distillation distillate comes out dirty.	Solvent foams.	Use anti-foaming discs, see page 17.
		Load less quantity of solvent.
		Reduce the working temperature.
		Reduce the compressed air feeding.
During drying distillate pigments.	Draws polluted products.	Separate the distillation phase than the drying ones. At the end of the distillation discharge the distillate tank and proceed to dry. At the end of drying wash the tank.

THERMIC OIL CHANGING PROCEDURES

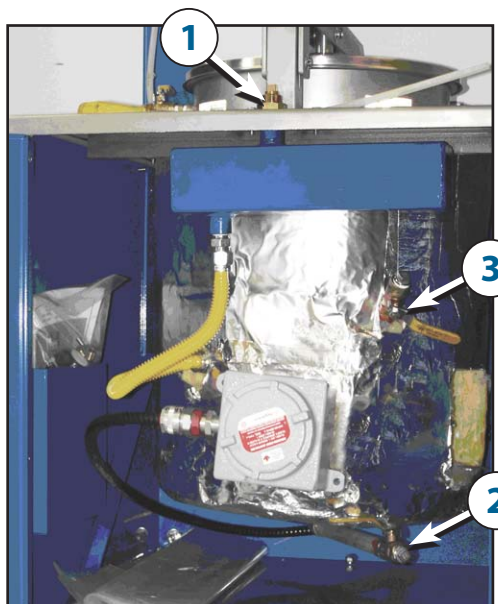

It is recommended to change the oil (330067 for SR30 or 330068 for SR60) & the cover seal :

- SR30 : 304018
- SR60 (black) 304023
- SR60V (orange) 304024

every 2000 hours of work or every year witch ever comes first.
See page 29 for oil change procedures.

1. Remove the overflow valve # (1) and remove the plug on the ball valve # (2) and open the breather valve # (3)
2. Place the empty oil collector container below the ball valve # (2) on open the valve to remove the used oil.
3. When empty, close the ball valve # (2), remove the container and re-install the plug on the ball valve # (2).
4. Install a funnel on (1) and pour new thermic oil into the funnel until full.
5. Close the ball valve (3) and re-install the vent tube plug on the ball valve (3) and the overflow valve (1).

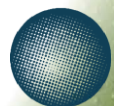

MAINTENANCE

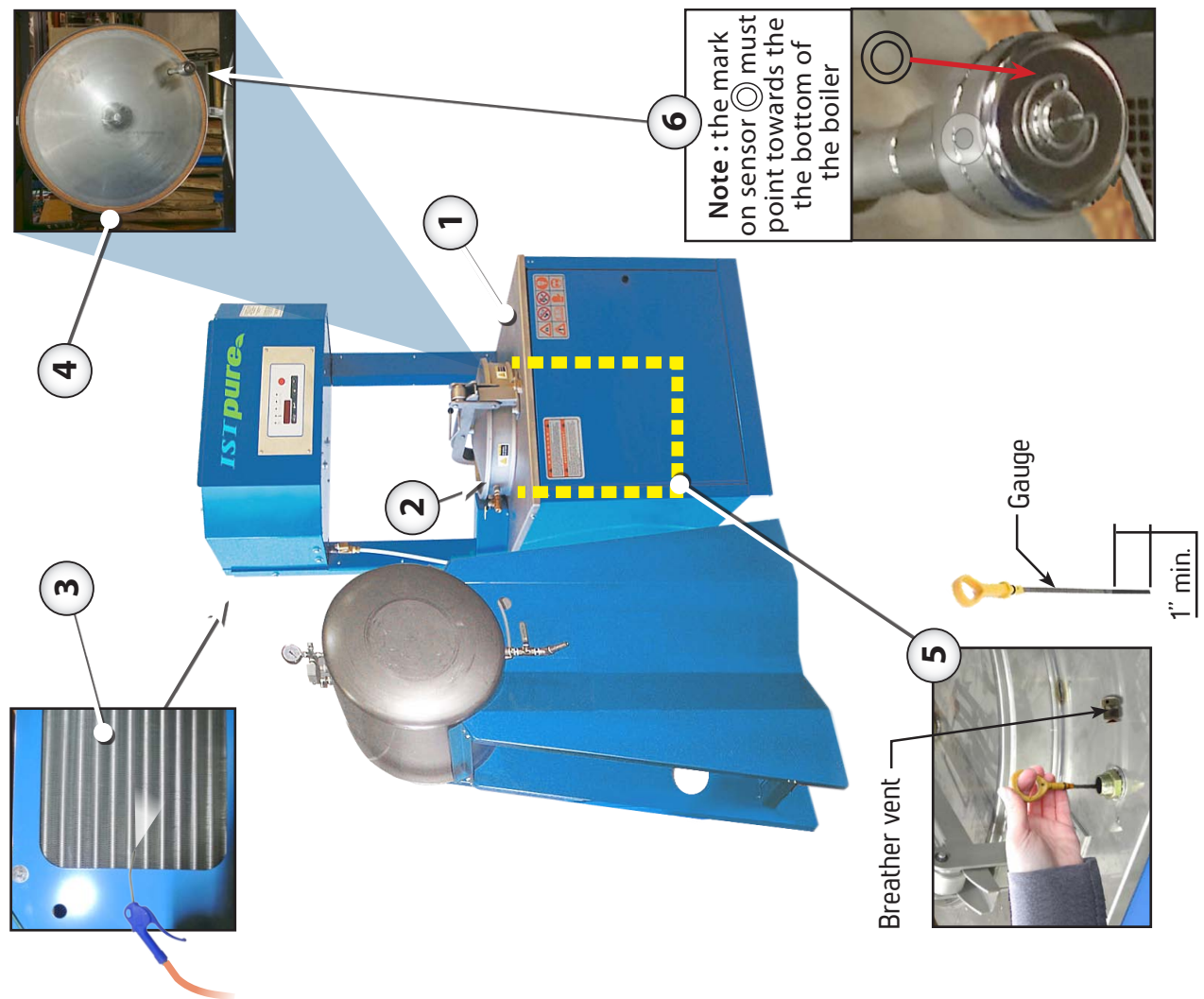

EVERY DAY

- Clean the work surface **1**
- Clean the boiler **2**

EVERY MONTH

- Clean the condenser **3** using a blow gun
- Check the seal condition **4** and replace as needed
- Check the oil level **5** in the overflow tank with a gauge and make sure it is at minimum 1"

EVERY 2,000 HOURS OF OPERATION

- Change the cover seal **4** (see details on page 30)
- Change oil **5** (see procedure on page 31)
- Clean the level sensor **6**

SR Models	Sealing gasket 4
SR30 (325030)	Black seal #304027 Orange seal #304018
SR30V (325031)	
SR60 (325050)	
SR60 (325060)	Orange seal #304023
SR60V (325061)	Black seal #304024

MAINTENANCE (CONT'D)

THERMAL OIL CHANGE PROCEDURE



STEPS TO OIL CHANGE PROCEDURE

A	Unscrew the breather vent (1A) or the elbow plug (1B) and remove the ball valve plug (2) .
B	Place an empty oil pan below the ball valve (2) and open the valve to drain the used oil.
C	When empty, close the ball valve (2) , remove the tray and screw the plug back on the ball valve (2) .
D	Remove the plug and open the ball valve (3) .
E	Insert a funnel into the vent hole (1A) oil into the elbow (1B) and pour in the new thermal oil until the oil spill out of the ball valve (3) .
F	Close the ball valve (3) and put back the square plug.
G	Continue pouring oil until it is completely filled. The oil level should be approximately 1" in the overflow tank. Check it with a dipstick.
H	Screw the breather vent back on (1A) or the elbow plug (1B)

Locate the breather vent **(1A)** or the elbow **(1B)**, Depending on the option (standard or high temperature)

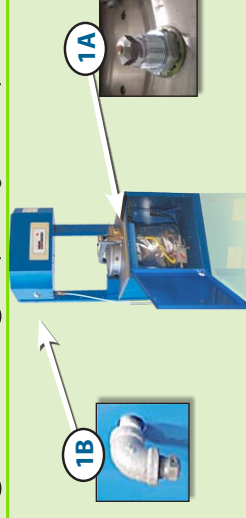

Models	Standard Unit	High Temperature Option
SR30-30V / 60-60V	1A	1B



Funnel



4

Oil Capacity

Please refer to the nameplate of your machine for the required oil volume.

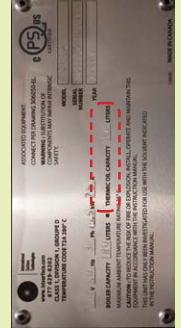

Thermal Oil		4	
Volume	Standard	High Temperature	
1 gal / 4L	330066	330166	
2.5 gal / 9.5 L	330067	330167	
5 gal / 19 L	330068	330168	
55 gal / 208 L	330069	330169	

MAINTENANCE (END)

REPLACING THE BOILER GASKET (ORANGE OR BLACK DEPENDING ON THE TYPE OF SOLVENT)

ORANGE RUBBER SEAL

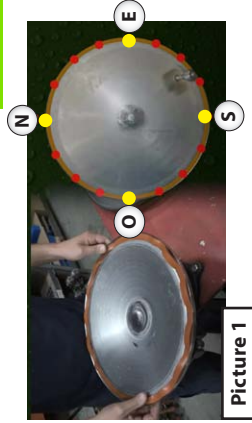

Picture 1

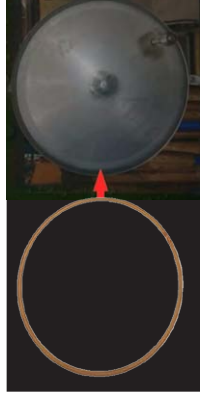

1. Remove-cut the old gasket with a cutter or a screwdriver, clean the gasket groove carefully with a rag impregnated with solvent.

2. Install the new gasket in place.

3. Using the cardinal points method, push the gasket with your thumb into the groove starting with the north, south, east, and west (Picture 1).

4. Then repeat the same process this time to the northeast, southwest, northwest, and southeast (Picture 2).

5. Finally, press the gasket halfway between each of the last two directions (Picture 3).

6. Using the gasket roller (RJ), finish placing the gasket evenly around the circumference (Picture 4).



Picture 2



Picture 3

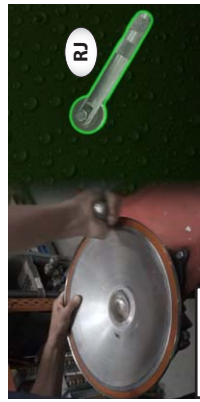

Picture 4

BLACK BRAIDED SEAL



1. Remove-cut the old gasket with a cutter or a screwdriver, clean the gasket groove carefully with a rag impregnated with solvent.

2. The new gasket is pre-cut at 45°, however it will need to be adjusted during installation.

3. Place the new gasket into the groove all around the cover, starting with one end pre-cut at 45° facing down. (Picture 5).

4. Using the gasket roller (RJ), finish placing the gasket evenly around the circumference.

5. The end of the gasket will overlap slightly over the other end in place. If needed, cut exceeding length at 45° so that it sits perfectly over the other end (Picture 6).

6. Once in place, the gasket must perfectly cover itself at both ends (Picture 7).



Picture 5



Picture 6



Picture 7



SR30 - SCHEMATIC OF UNIT

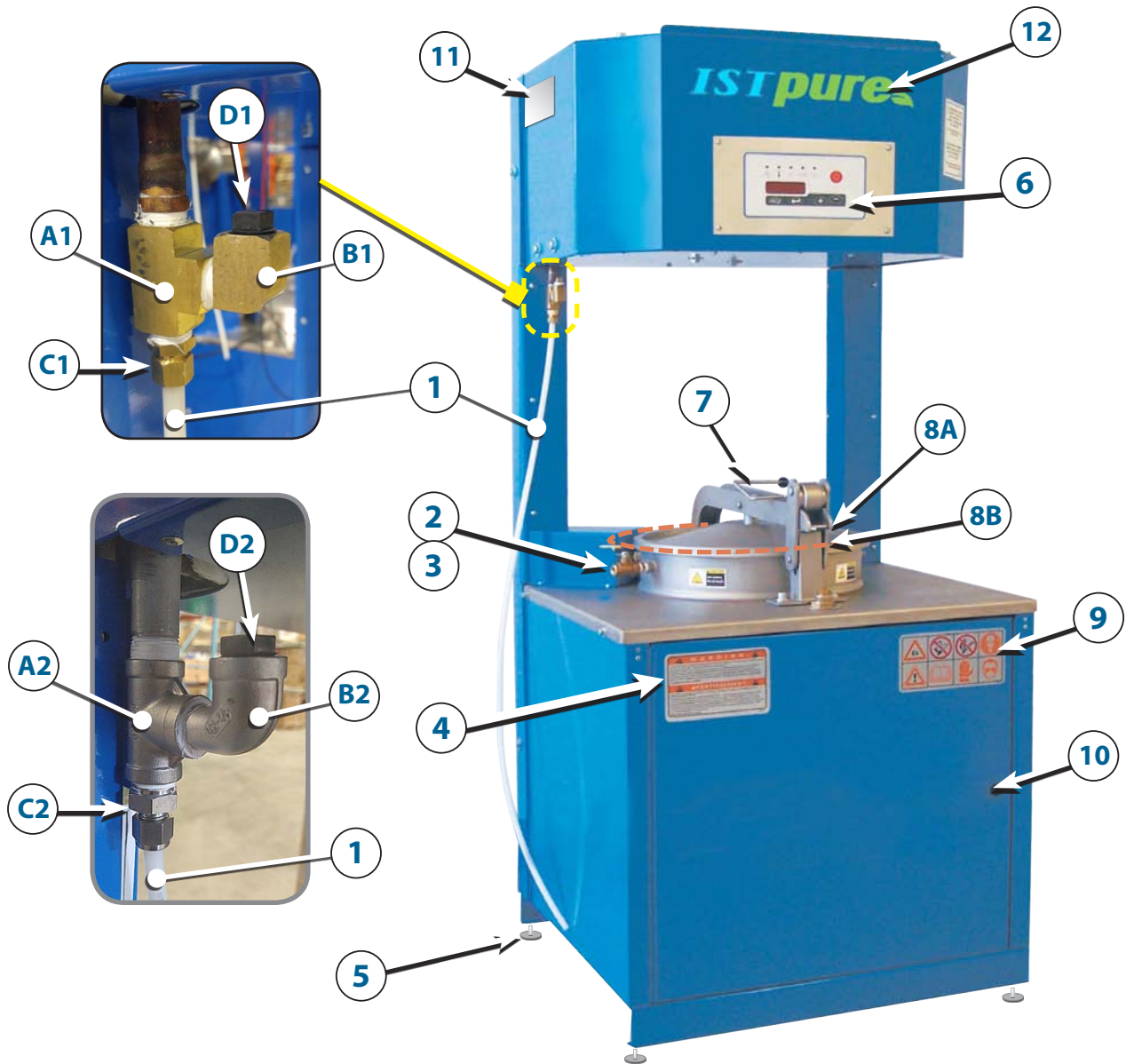

#	N° PIÈCE	DESCRIPTION	Qté
A1	632524	3/8" BRASS "T"	1
A2	323205	1/2" S/S "T"	1
B1	632551	3/8" BRASS ELBOW	1
B2	323186	1/2" S/S ELBOW	1
C1	323127	3/8" BRASS COMP. FITTING	1
C2	323208	3/8" S/S COMP. FITTING	1
D1	323071	3/8" PIERCED PLUG FOR BRASS	1
D2	323072	1/2" PIERCED PLUG FOR S/S	1
1	324512	NYLON HOSE 3/8"	4
2	323006	BRASS BALL VALVE 1/4"	1
3	323193	S/S BALL VALVE 1/4"	1

Nb	PART #	DESCRIPTION	Qty
4	331001	WARNING STICKER	1
5	612427	LEVELERS	4
6	307003	KEYBOARD	1
7	323114	COMPLETE HANDLE	1
8A	301018	COVER	1
8B	304018	ORANGE GASKET	1
9	331011	WARNING SYMBOLS STICKER	1
10	323117	DOOR LOCK	1
11	330020	QPS NAME PLATE	1
12	331053	ISTpure sticker	1



SR60 – SCHEMATIC OF UNIT

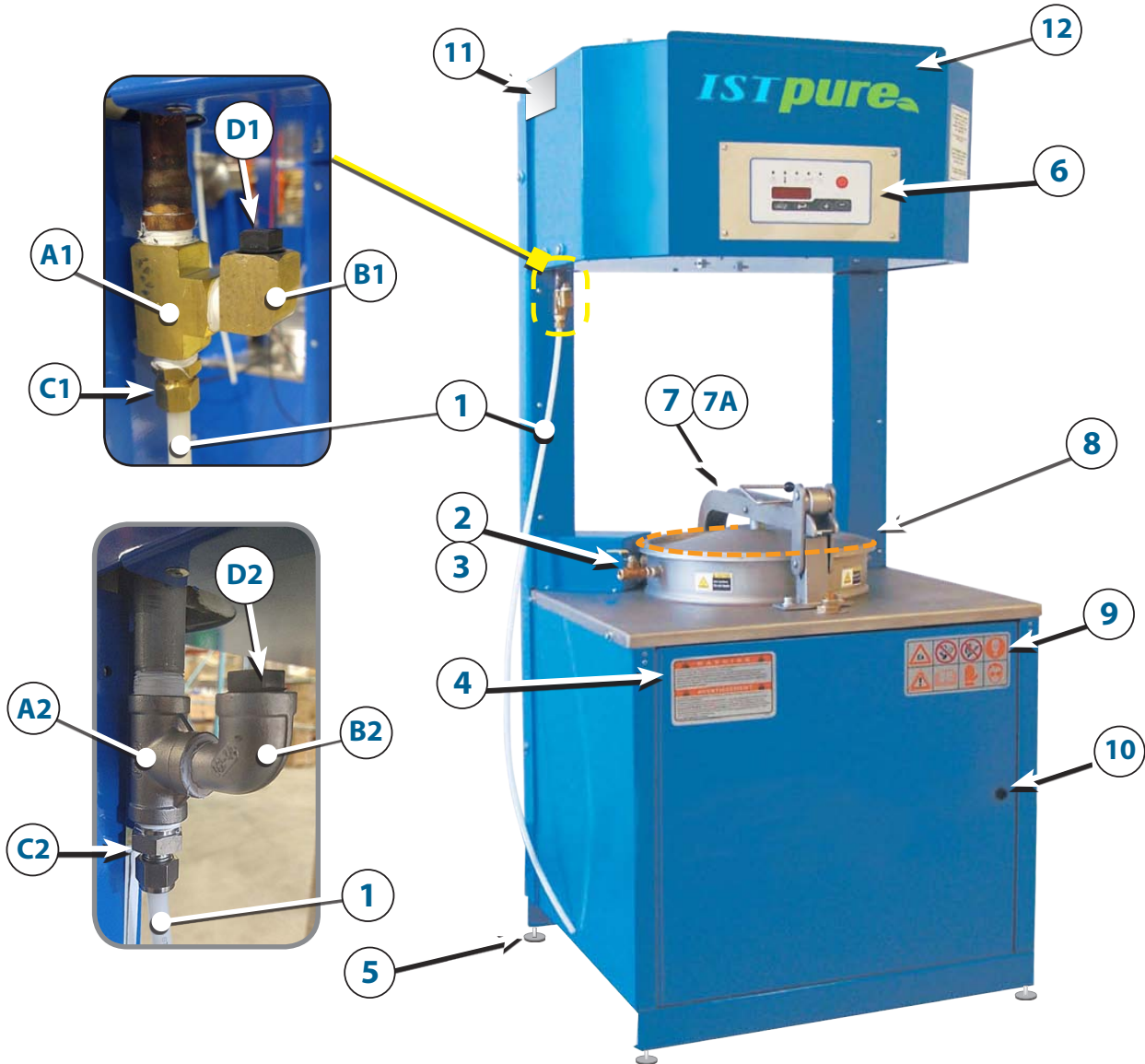

Nb	PART #	DESCRIPTION	Qty	Nb	PART #	DESCRIPTION	Qty
A1	632524	3/8" BRASS "T"	1	3	323193	S/S BALL VALVE 1/4"	1
A2	323205	1/2" S/S "T"	1	4	331001	WARNING STICKER	1
B1	632730	1/2" BRASS ELBOW	1	5	323076	LEVELERS	4
B2	323186	1/2" S/S ELBOW	1	6	307003	KEYBOARD	1
C1	323127	RACC. COMP. EN LAITON 3/8"	1	7	323114	COMPLETE HANDLE	1
C2	323208	RACC. COMP EN INOX. 3/8"	1	7A	ST3043	LOCKING MECHANISM	1
D1	323072	1/2" PIERCED PLUG (SAME FOR BRASS & S/S)	1	8	301018	COVER WITH ORANGE GASKET	1
D2			1	9	331011	WARNING SYMBOLS STICKER	1
D	632744	BRASS HEX REDUCER 1/2" M - 3/8" F	1	10	323117	DOOR LOCK	1
1	324512	NYLON HOSE 3/8"	4	11	330020	QPS NAME PLATE	1
2	323006	BRASS BALL VALVE 1/4"	1	12	331053	ISTPURE STICKER	1



SR30/30V SCHEMATIC OF UNIT - TOP VIEW

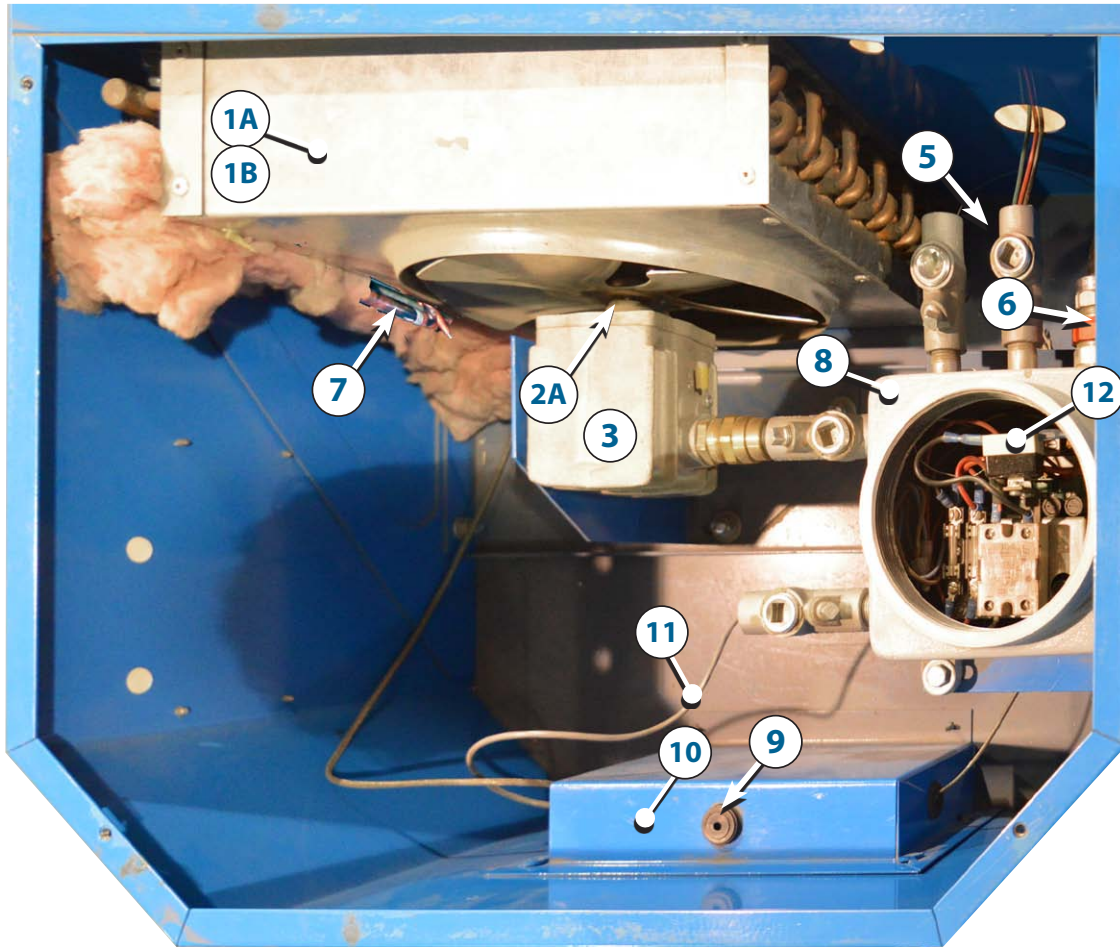

Nb	PART #	DESCRIPTION	Qty
1A	305004	COPPER CONDENSOR	1
1B	306010	S/S CONDENSOR	1
2	303003	FAN BLADE	1
3	303001	MOTOR	1
5	322012	EXPL. PROOF EYS FITTING	4
6	322004	TECK CONNECTOR	2

Nb	PART #	DESCRIPTION	Qty
7	307123	TEMP.SENSOR FOR SOLVENT	1
8	322001	EXPLOSION PROOF BOX	1
9	307016	AUDIBLE ALARM	1
10	307041	CONTROL BOARD	1
11	307127	COMMUNICATION CABLE	1
12	308010	HIGH LIMIT THERMOSTAT	1



SR60/60V SCHEMATIC OF UNIT – TOP VIEW

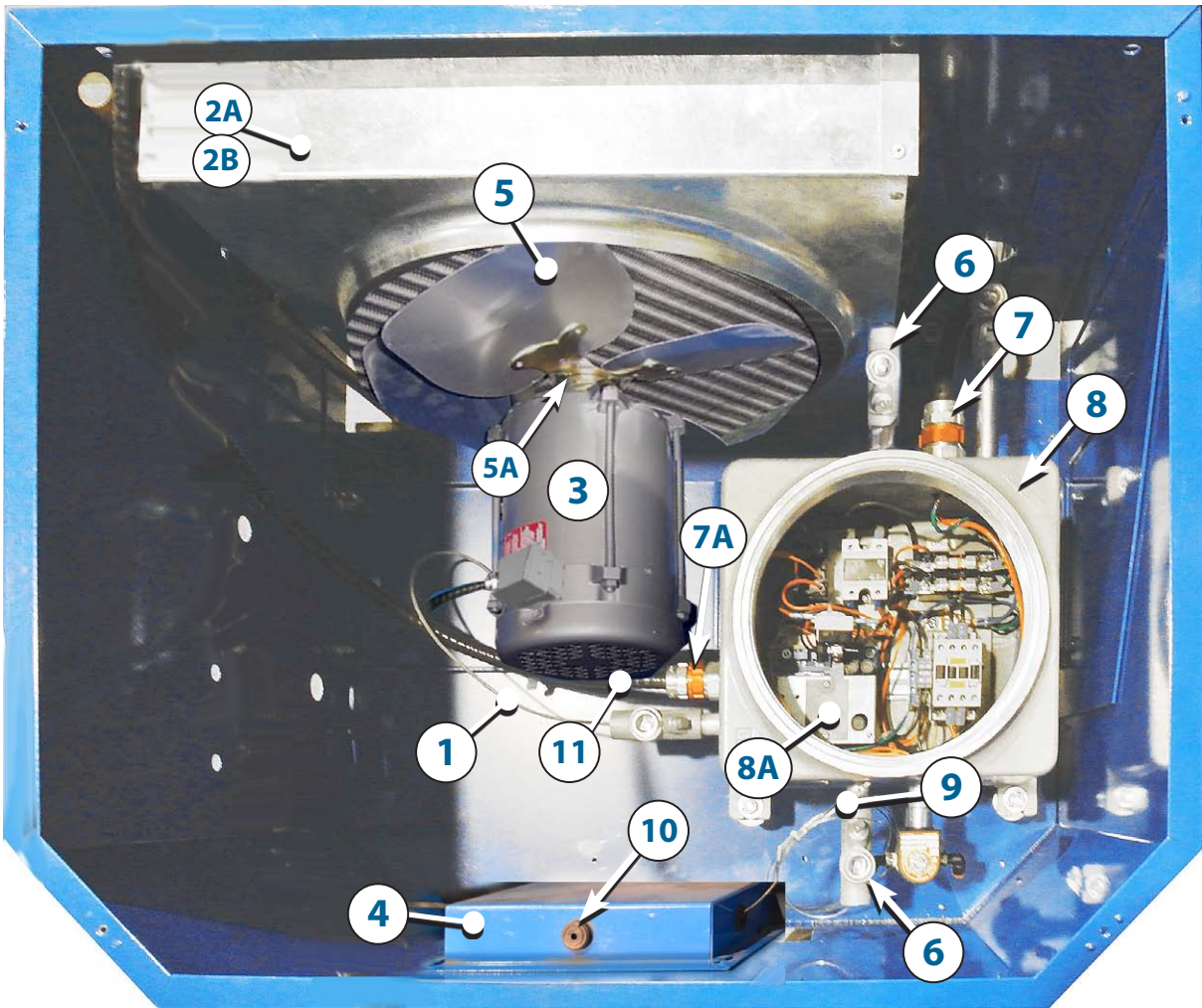

Nb	PART #	DESCRIPTION	Qty
1	307127	COMMUNICATION CABLE	1
2A	305005	COPPER CONDENSOR	1
2B	306011	S/S CONDENSOR	1
3	303024	MOTOR	1
4	307041	CONTROL BOARD	1
5	303012	MOTOR FAN BLADE	1
5A	303011	5/8" HUB	1
6	322012	« EYS » CONNECTORS	2

Nb	PART #	DESCRIPTION	Qty
7	322003	3/4" TECK CONNECTOR	1
7A	322004	1/2" TECK CONNECTOR	1
8	322033	EXPLOSION PROOF BOX	1
8A	308010	HIGH LIMIT THERMOSTAT	1
9	307122	OIL HEAT SENSOR	1
10	307016	AUDIBLE ALARM	1
11	321003	TECK CABLE	1



SR30 & SR60 SCHEMATIC OF UNIT - OIL CHAMBER

Optional sludge monitoring safety device

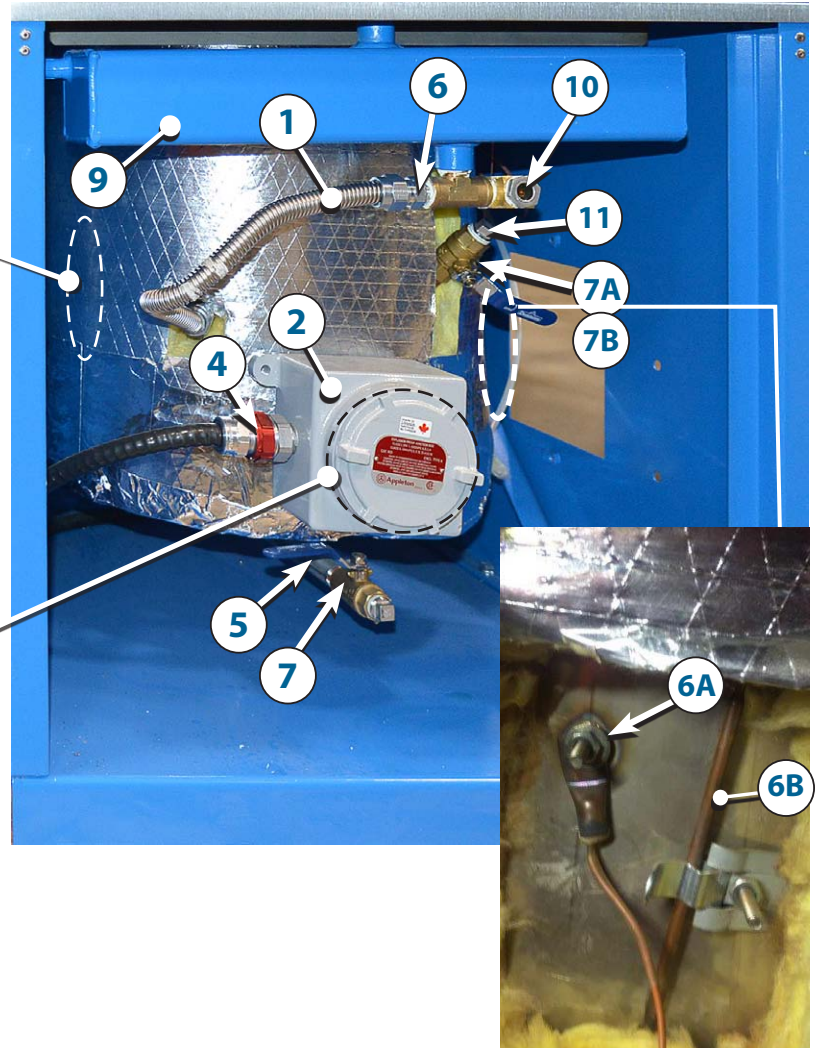
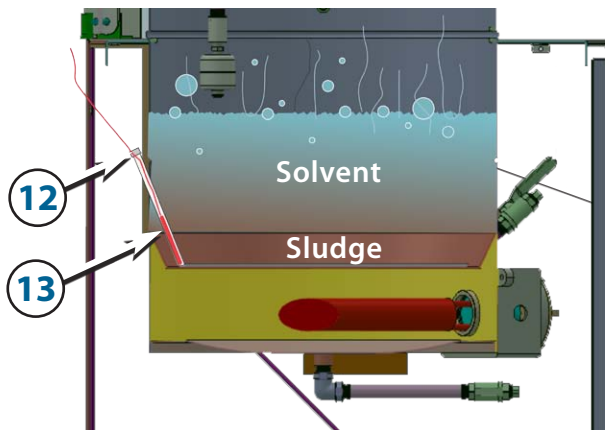

Nb	PART #	DESCRIPTION	Qty
1	323152	OIL FLEXIBLE TUBE	1
2	322002	EXPLOSION PROOF BOX	1
3	302002	SR30 HEATER	1
3A	302004	SR60 HEATER	1
4	322004	½" TECK CONNECTOR (SR30)	1
	322003	½" TECK CONNECTOR (SR60)	1
5	323527	LONG NIPPLE ½" X 8"	1
6	NPN	NIPPLE	1
6A	307122	OIL TEMPERATURE DETECTOR	1
6B	308005	THERMOSTAT PROBE	1

Nb	PART #	DESCRIPTION	Qty
7A	608102	BRASS BALL VALVE ½"	2
7B	908117	STAINLESS STEEL BALL VALVE ½"	2
8	304100	INSULATION SHEATH	*
9A	320032	SR30 OVERFLOW TANK	1
9B	320042	SR60 OVERFLOW TANK	1
10	310010	OIL LEVEL SIGHT GLASS	1
11	323522	½" INOX PLUG	2
OPTION: SLUDGE MONITORING SAFETY DEVICE			
12	323225	CONNECTOR FOR SENSOR	1
13	321031	SENSOR FOR SLUDGE	1

* Sold by foot



SR30/60 SCHEMATIC OF UNIT - REAR VIEW



Nb	PART #	DESCRIPTION	Qty
1	322006	JUNCTION BOX (EXPLOSION PROOF)	1
2	323086	GROUND CABLE WITH CLIP	1



AUTO-FILL : VALVE & PUMP SETS

SR30

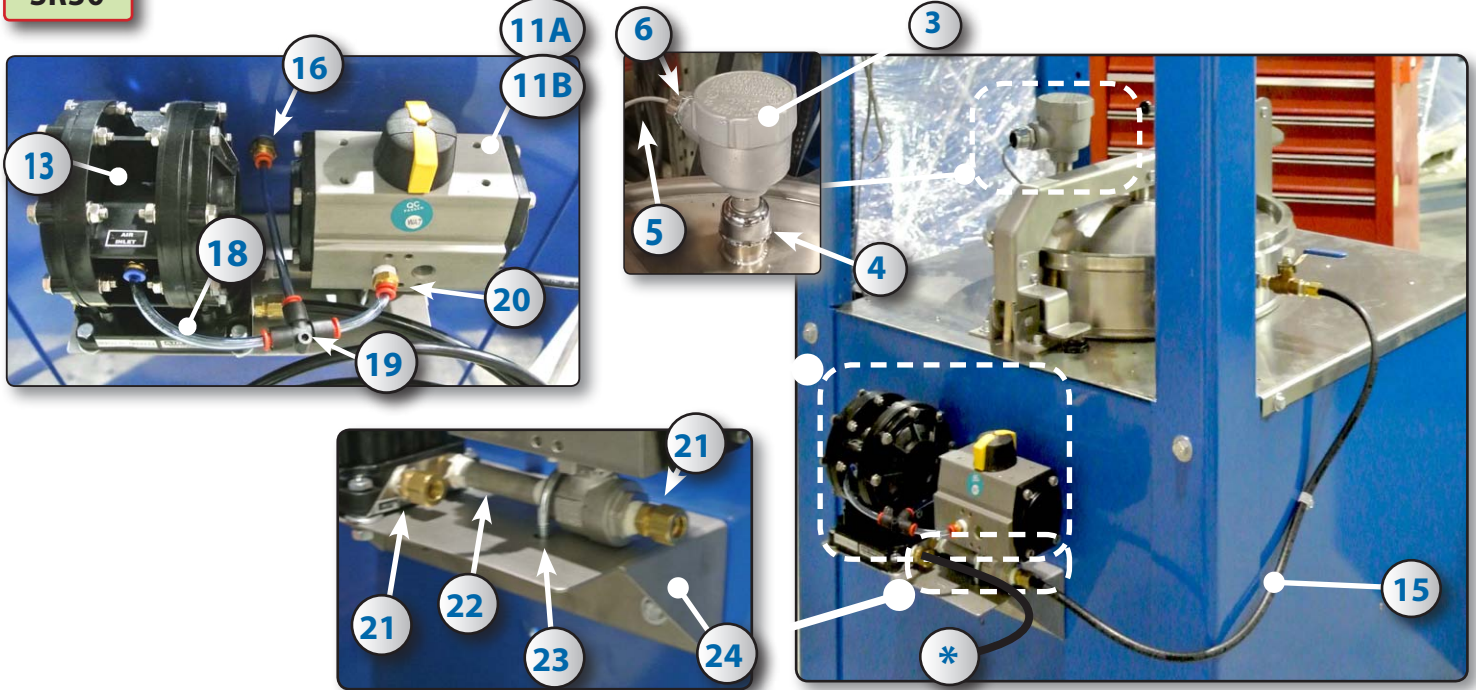

SR60

If the serial number of your unit is lower than T1-91X2-0257, it is running on a pump that has been replaced since.

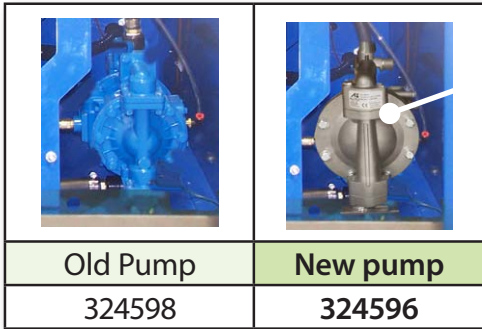

You will need a retrofit kit to accommodate the new pump.

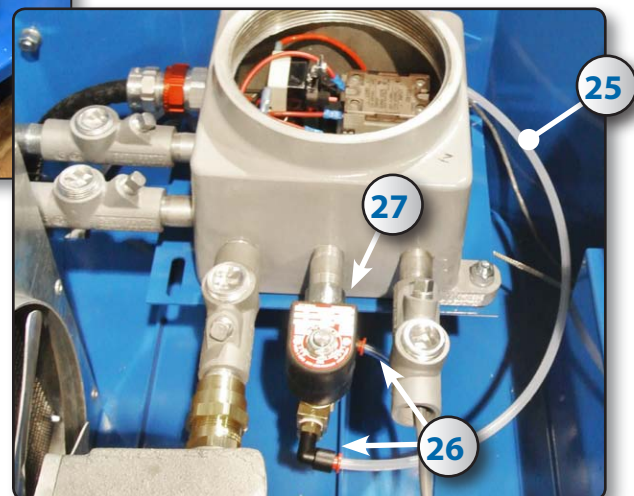
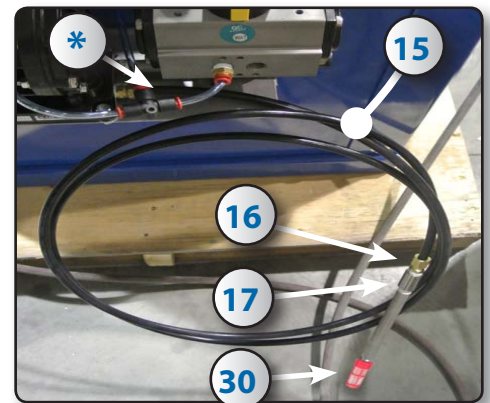
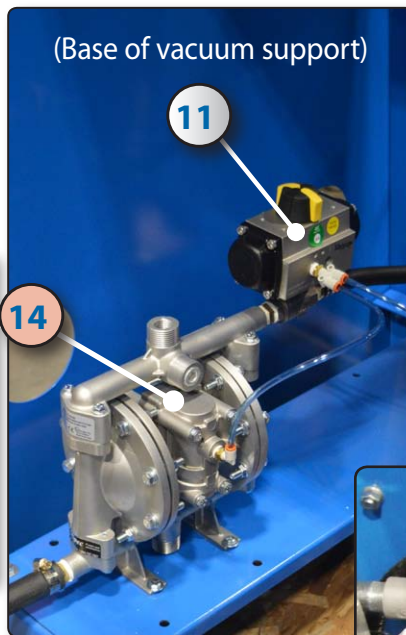



AUTO-FILL : INTERIOR BOILER & DETAILS

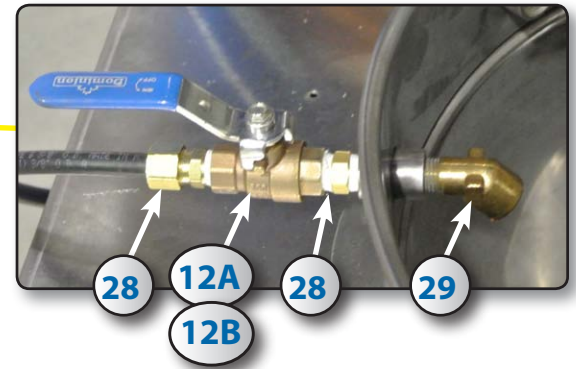
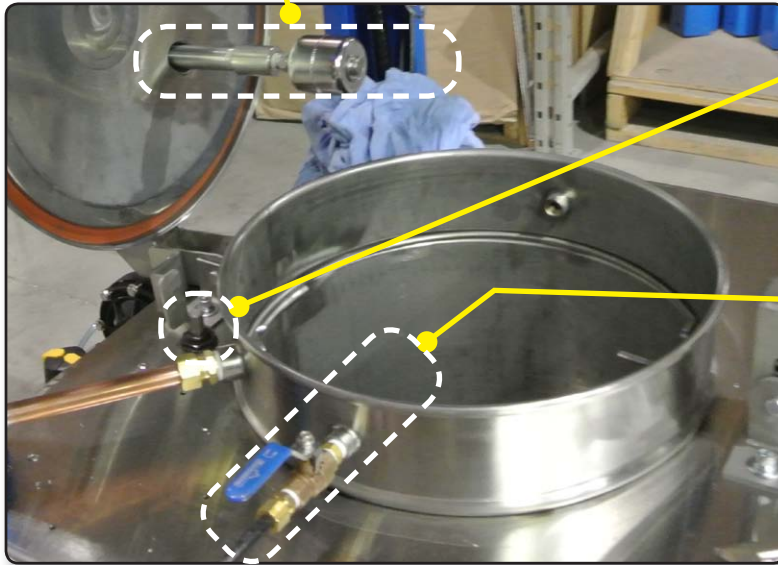
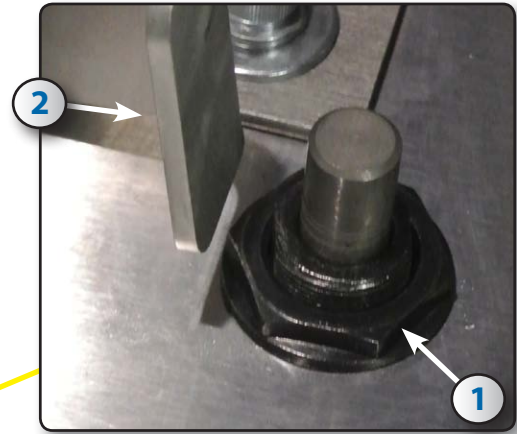
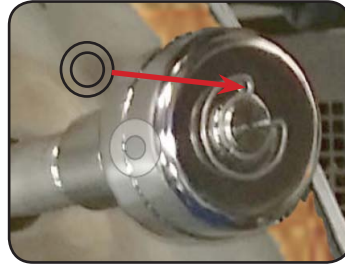
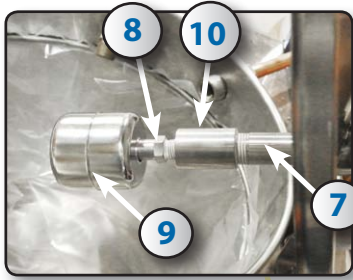

ID	Part #	Description
1	314582	COVER SWITCH
2	NPN	SUPPORT
3	322006	JUNCTION BOX
4	919811	COUPLING
5	314066	COMMUNICATION CABLE
6	616740	CONNECTOR 2521
7	323527	NIPPLE
8	323501	COUPLING
9	919810	LEVEL SWITCH
10	919812	REDUCTOR COUPLING
11A	324537	1/4" ROTEX ACTUATOR VALVE (SR30)
11B	324509	1/2" ROTEX ACTUATOR VALVE (SR60)
12A	323006	1/4" BRASS BALL-VALVE
12B	323193	1/4" S/S BALL-VALVE
13	324543	ECO PUMP (SR30 ONLY)
14	324596	PUMP (SR60 ONLY)
14A	324592	RETROFIT KIT FOR NEW PUMP

ID	Part #	Description
16	323166	3/8" PL FITTING
17	325501	1/4" S/S FITTING
18	324571	1/4" BLUE HOSE
19	324584	"T" PUSH-IN FITTING
20	324570	1/4" @ 1/8" PUSH-IN V
21	323130	ADAPTOR
22	323508	1/4" X 3" NIPPLE
23	624308	1/4" X 1 1/8" "U" BOLT C/W BOLTS & NUTS
24	NPN	SUPPORT PLATE
25	606101	1/4" PVC NYLON HOSE
26	324560	1/4" - 90° PUSH-IN FITTING
27	324003	SOLENOID VALVE
28	323130	COMPRESSION CONNECTOR 3/8" X 1/4"
29	323190	SPOUT : 1/4" PL 45° MF ELBOW
30	324624	FILTER SUCTION STRAINER



SCHEMATIC OF UNIT – CONTROL BOARD

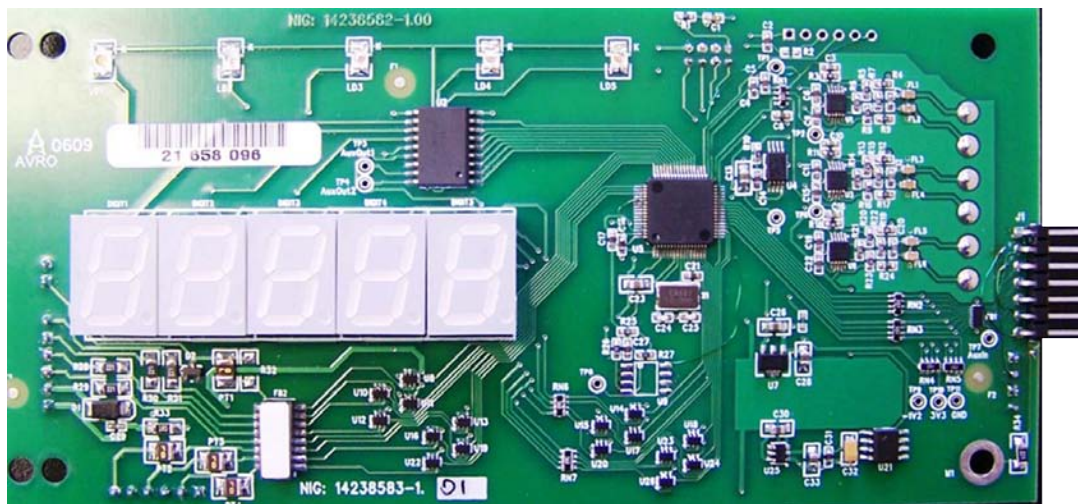
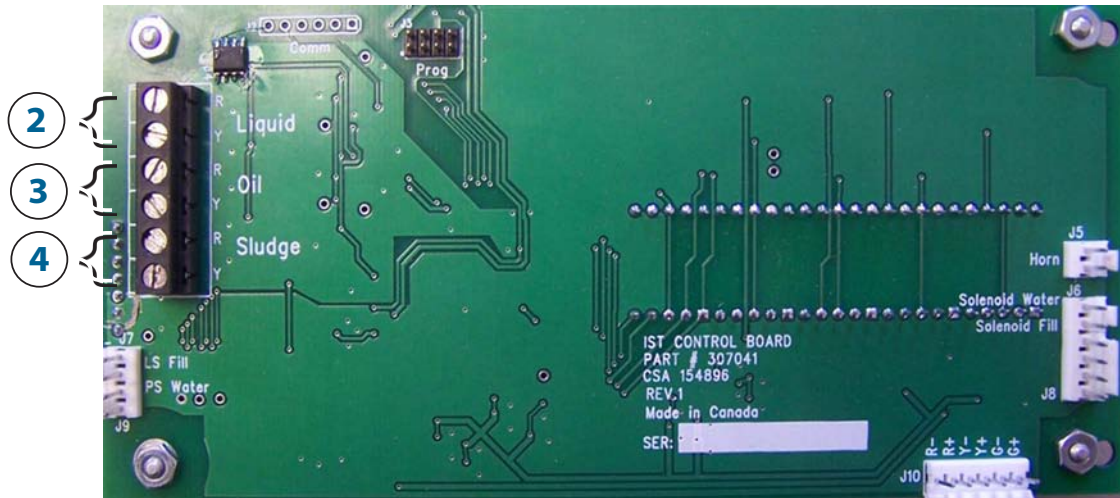

Nb	PART #	DESCRIPTION	Qty
1	307041	CONTROL BOARD	1
2	307123	TEMP. SENSOR FOR SOLVENT	1
3	307122	OIL HEAT SENSOR	1
4	321031	SLUDGE THERMOCOUPLE	1



SCHEMATIC OF UNIT - ELECTRICAL BOXES

POWER SUPPLY FOR SR30 (307050)

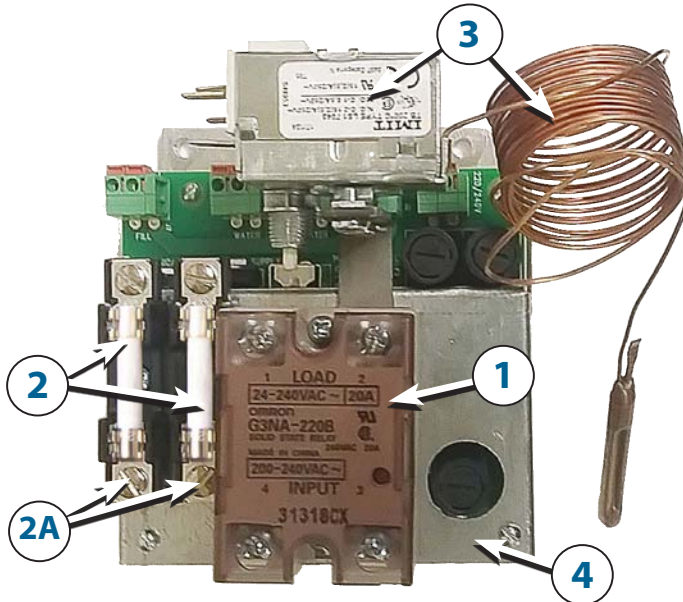

NB	PART #	DESCRIPTION	QTY
1	303053	SOLID STATE RELAY	1
2	616922	FUSE	2
2A	307017	FUSE HOLDER	2
3	308005	THERMOSTAT	1
4	330009	INTRINSICALLY BARRIER	1

ELECTRICAL BOX FOR SR60 (307051??)

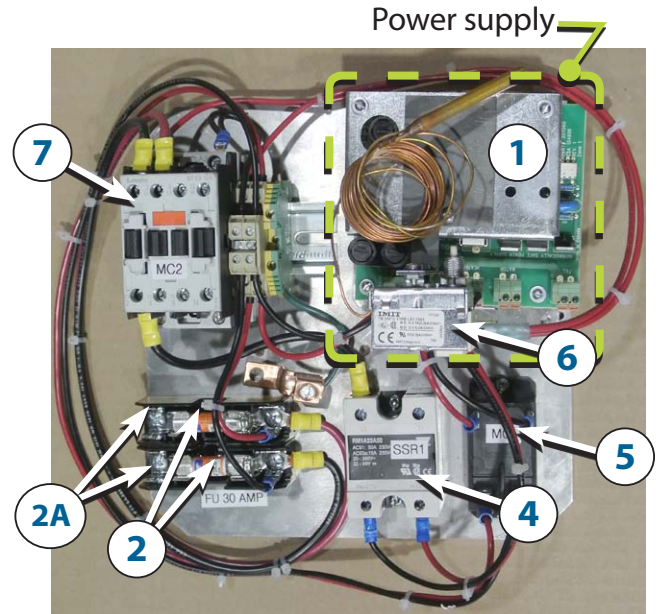

NB	PART #	DESCRIPTION	QTY
1	330009	INTRINSICALLY BARRIER	1
2	917725	FUSE	2
2A	917738	FUSE HOLDER	2
4	314059	OVERLOAD SS RELAY	1
5	303056	POWER RELAY	1
6	308005	THERMOSTAT	1
7	314051	CONTACTOR 7.5hp-240V	1

POWER SUPPLY ELECTRONIC CARD (SR30/60)

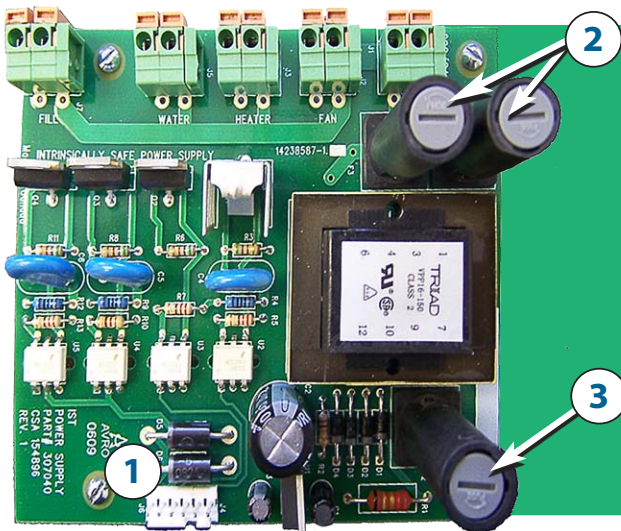

Nb	PART #	DESCRIPTION	Qty
1	307040	ELECTRONIC CARD	1
2	307130	FUSE	2
3	307131	FUSE	1



SR30 ELECTRICAL DRAWING

(with one heater of 2 500 W)

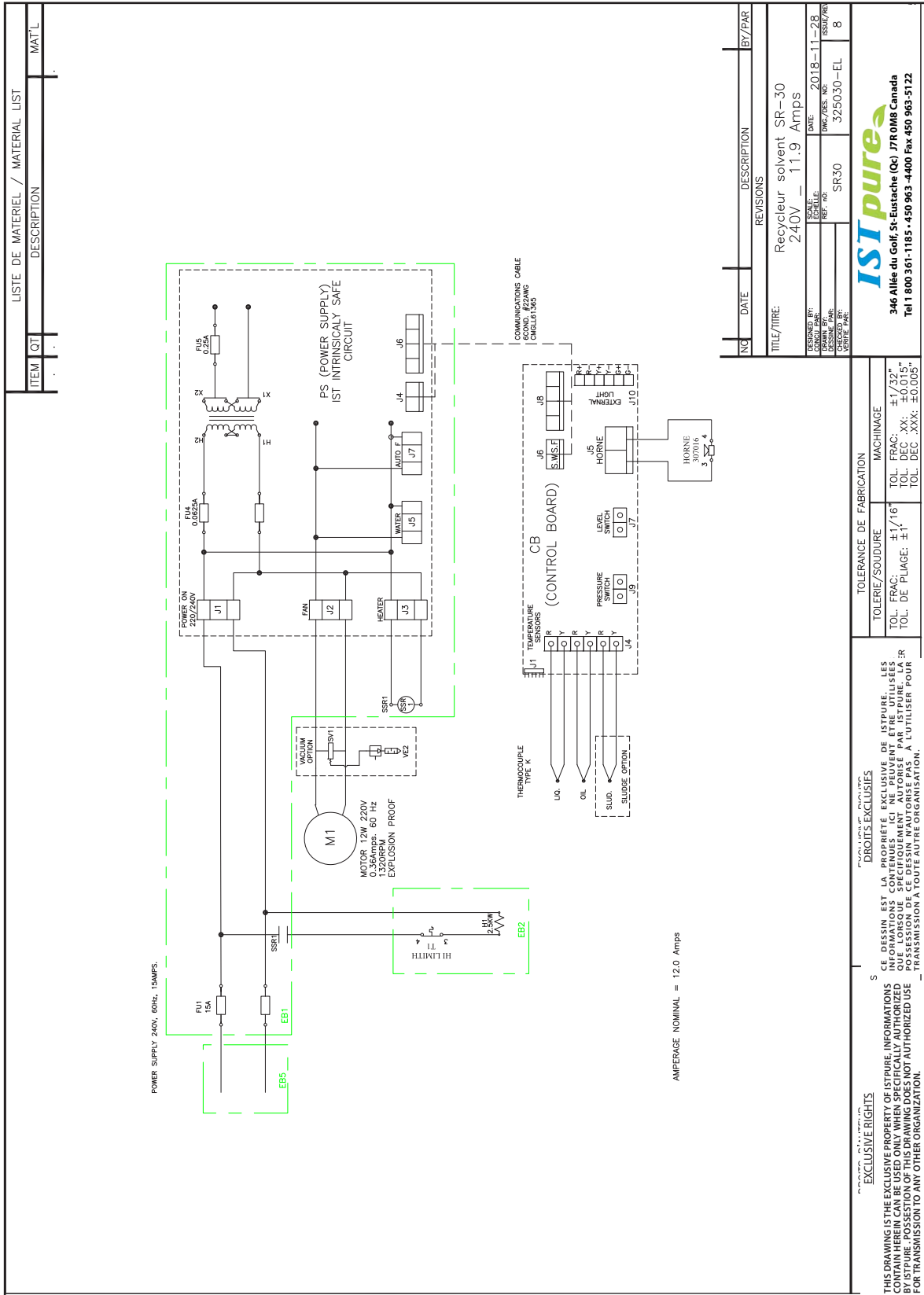



SR60 ELECTRICAL DRAWING
(with one heater of 5 000 W)

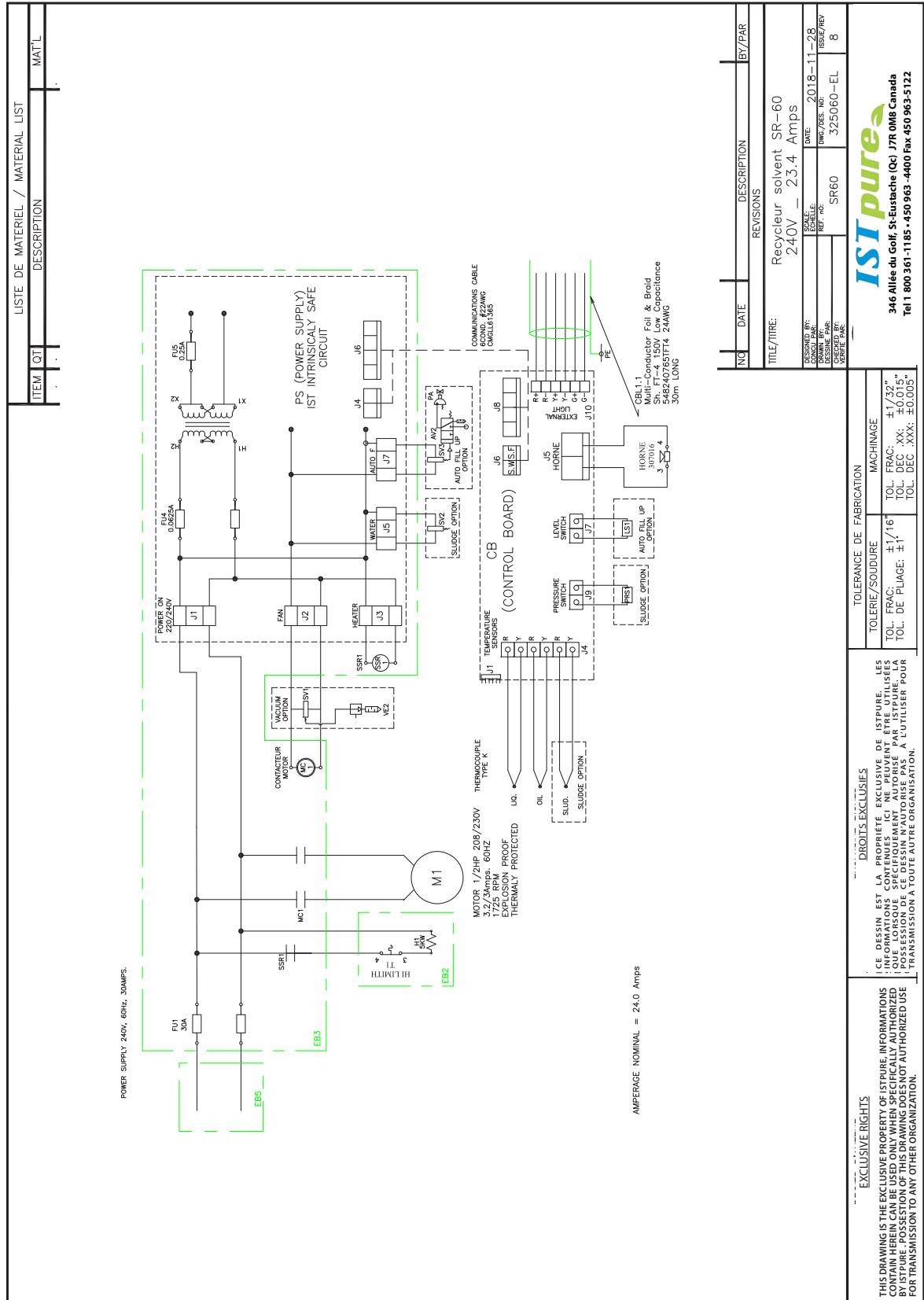

NO	DATE	DESCRIPTION	BY/PAR
REVISIONS			
TITLE/TITRE: Recycleur solvant SR-60 240V - 23.4 Amps			
DESIGNED BY:	SCALE:	DATE: 2018-11-28	ISSUE/REV: 8
DRAWN BY:	DWG/ISS. NO.:	SR60	ISSUE/REV: 8
CHECKED BY:	REF. NO.:		
VERIFIER PAR:			

ISTpure
346 Allée du Golf, St-Eustache (Qc) J7R 0M8 Canada
Tel 1 800 361-1185 • 450 963-4400 Fax 450 963-5122

TOLERANCE DE FABRICATION	MACHINAGE
TOLERIE/SOUDURE	
TOL. FRAC: ±1/16"	TOL. DEC: ±0.005"
TOL. DE PLAGE: ±1"	TOL. DEC: ±0.005"

DROITS EXCLUSIFS

CE Dessin est LA PROPRIÉTÉ EXCLUSIVE DE ISTPURE. LES DROITS EXCLUSIFS DE CE Dessin sont réservés à ISTPURE. LA REPRODUCTION, L'UTILISATION, LA COPIE, LA PHOTOCOPIE, LA REPRODUCTION, LA TRANSMISSION À TOUTE AUTRE ORGANISATION, LA REPRODUCTION, LA PHOTOCOPIE, LA REPRODUCTION, LA TRANSMISSION À TOUTE AUTRE ORGANISATION.

THIS DRAWING IS THE EXCLUSIVE PROPERTY OF ISTPURE. INFORMATION CONTAINED HEREIN CAN BE USED ONLY WHEN SPECIFICALLY AUTHORIZED BY ISTPURE. POSSESSION OF THIS DRAWING DOES NOT AUTHORIZE USE FOR TRANSMISSION TO ANY OTHER ORGANIZATION.



OPTIONAL VACUUM DIAGRAM

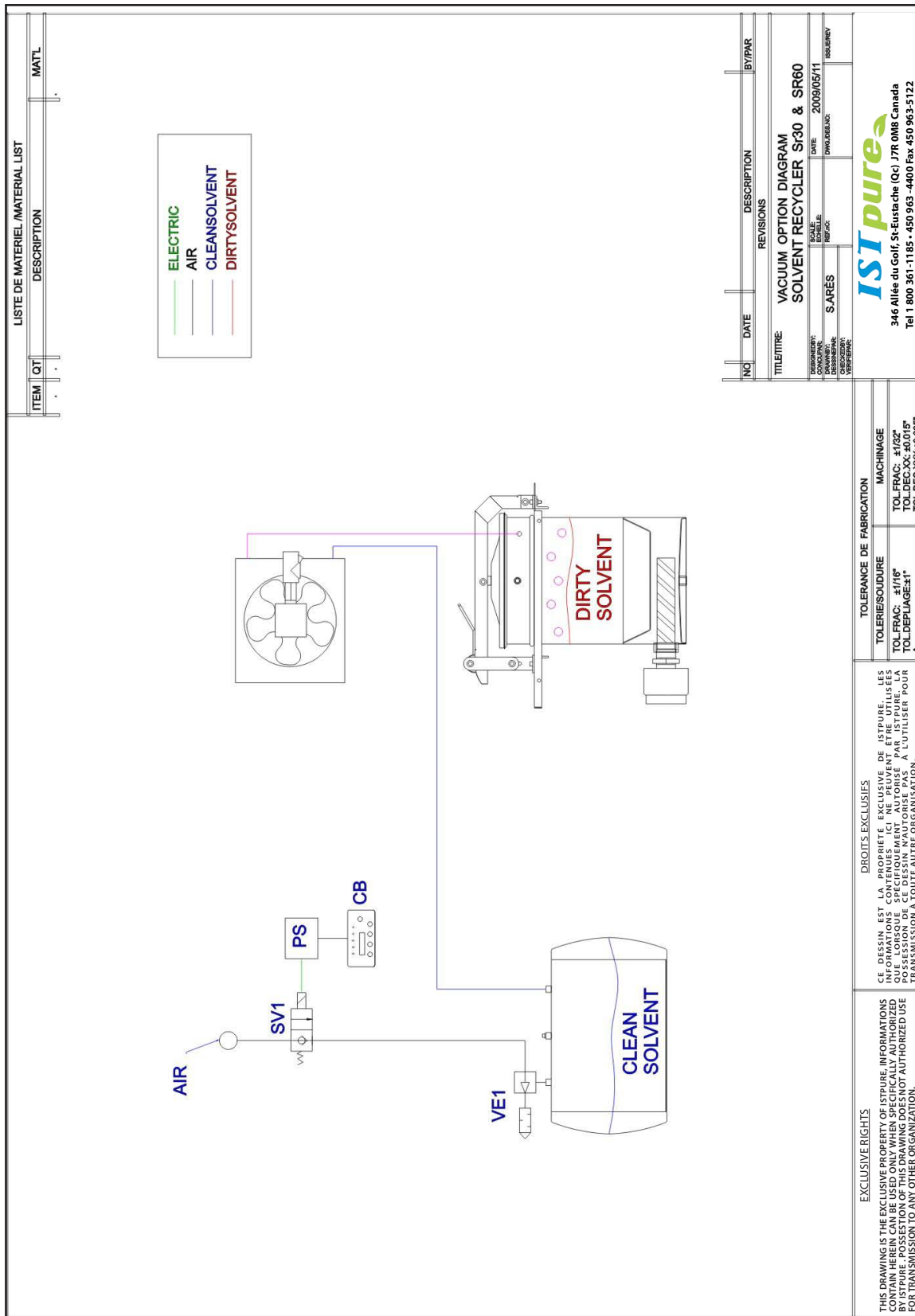



OPTIONAL VACUUM DISTILLATION SECTION



(SR30 SHOWN)

The boiling temperature of the solvents reported on pages 9–10 measured for atmospheric pressure operation of 1,000 hPa (760 mm Hg).

It is well known that by reducing the pressure, the boiling temperature of any substance is reduced.

When vacuum is created inside the distillation appliance, the boiling temperature is considerably reduced.

A distillation vacuum system on your SR30 or SR60 model will reduce boiling temperatures by about 30% leading to less energy consumption.

Vacuum distillation is recommended in the following cases :

1. When processing solvents with a **boiling temperature greater than 70°C (158°F)**.
2. Compulsory when processing solvents **with a boiling temperature greater than 60°C (140°F)**. Operating at a higher temperature can create problems on the cover seal
3. When processing solvents with **ignition point too close to their boiling temperature** can create a hazard or the solvent can degenerate and become an acid base and therefore cannot be re-used.
4. **When processing chlorinated solvents, atmospheric pressure distillation allows only a partial recovery of these solvents; at the end of the process the residues will still contain 20% of solvents.**

This happens because as the percentage of oil in the solvent increases, so does the temperature.

Chlorinated solvents have specific critical temperatures which when breached provoke the decomposition of the solvents leading to the formation of hydrochloric acid. This process will make the end product unusable.



OPTIONAL VACUUM DISTILLATION SECTION

Examples

Product to be distilled : Perchloroethylene

Distillation temperature at atmospheric pressure :121°C
 Distillation temperature at vacuum condition (223 hPa) :84°C
 Critical temperature of decomposition :150°C

A. Boiling range of clean perchloroethylene at atmospheric pressure: 1,000 hPa.

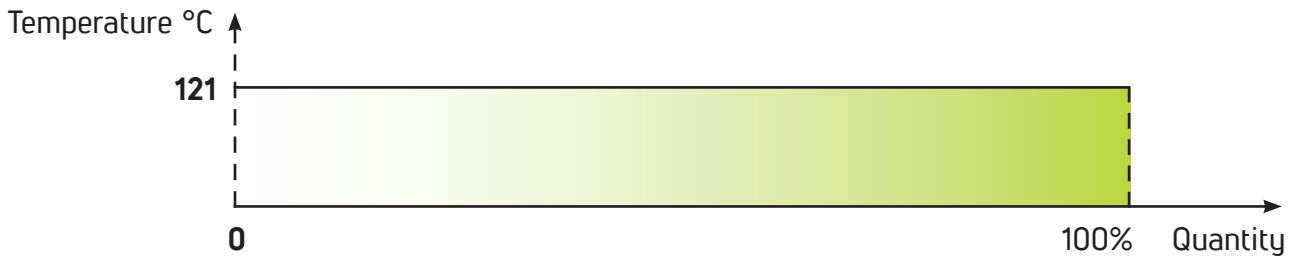

The distillation temperature of a clean solvent remains the same until the process of the whole cycle is complete.

B. Boiling range of clean perchloroethylene at vacuum condition: 223 hPa

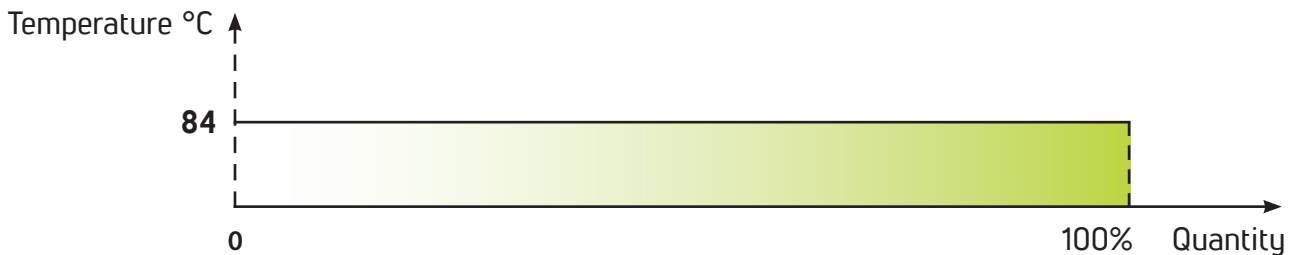

The distillation temperature of a clean solvent remains the same until the process of the whole cycle is complete.

C. Boiling range at atmospheric pressure (1,000 hPa) of a mixture of 90% perchloroethylene + 10% of oil.

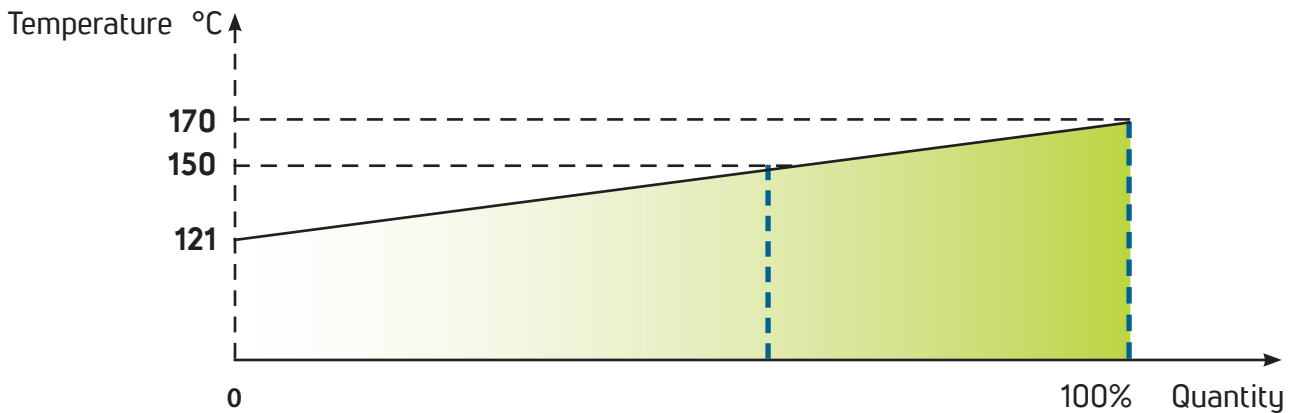

Once a temperature of 150°C (302°F) is reached, which is the critical non-supportable temperature, only 80% of perchloroethylene will be recovered.

The distillation temperature of the contaminated solvents increases during the process; this variation depends on the degree of contamination and on the type of contaminating substances.



OPTIONAL VACUUM DISTILLATION SECTION

D. Distillation temperature at vacuum condition (223 hPa) of a mixture of 90% perchloroethylene + 10% of oil.

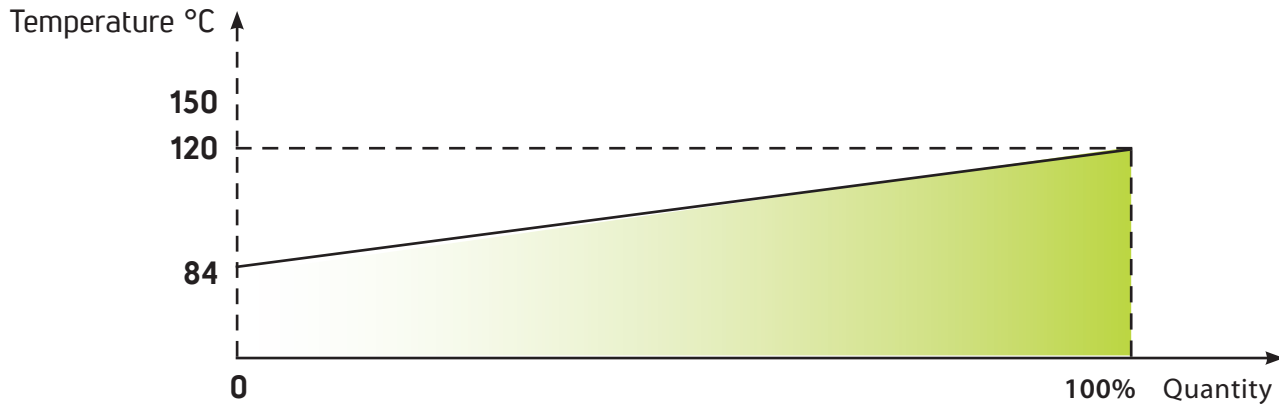

Operating with vacuum condition, 100% of perchloroethylene will be recovered when set at 120°C (248°F) and very far from the critical temperature of 150°C (302°F).

When distilling chlorinated solvents, the vacuum distillation is indispensable; this type of process is also necessary for minimal quantities of contaminants because of two specific reasons:

1. Yields 100%.
2. If the residual oil is contaminated with more than 2% of solvent, waste recycling companies will not accept it.

The distillation temperature of the contaminated solvents increases during the process; this variation depends on the degree of contamination and on the type of contaminating substances.



OPERATING PRINCIPLES – VACUUM DISTILLATION

Before reading this section, it is mandatory to read the previous section regarding the distillation at atmospheric pressure.

Unlike what occurs during atmospheric distillation, the distillation unit and the distillate collection tank are a single body.

A pneumatic vacuum generator joined at the solvent recovery tank provides the creation of the vacuum circuit.

Boiler Condenser Tank

The vacuum generator is fed with compressed air with a pressure of 70-100 P.s.i. with a maximum negative pressure of -27 P.s.i., -590 mm Hg.

NOTE : WITH VACUUM DISTILLATION IT IS POSSIBLE TO DISTILL SOLVENTS WITH DISTILLATION TEMPERATURE HIGHER THAN 60°C (140°F) AT ATMOSPHERIC PRESSURE.

For example, distilling at vacuum condition the Acetone, which has a distillation temperature of 56°C (133°F) at atmospheric pressure, will reach a boiling point of 39°C (101°F). Considering that the condenser is by air, if the temperature result is higher than 20°C (70°F) you will obtain a partial condensation of the solvent with an emission of Acetone vapor in the air.

OPERATING METHODS

DISTILLATION : AT ATMOSPHERIC PRESSURE

DRYING : AT VACUUM CONDITIONS

When processing solvents with distillation temperature lower than 60°C (140°F), polluted with liquid products.

DISTILLATION : AT ATMOSPHERIC PRESSURE

DRYING : AT VACUUM CONDITIONS

When processing solvents with distillation temperature higher than 60°C (140°F), polluted with solid products.

DISTILLATION : AT ATMOSPHERIC PRESSURE

DRYING : AT VACUUM CONDITIONS

In this case the process of the solvent reducers distillation temperatures between 60°-200°C (140°-392°F), and polluted with liquid products.



INSTALLATION (AT VACUUM CONDITION)

1. Connect the solenoid inlet to the compressed air circuit with a nylon tube of 3/8".

PRESSURE OF COMPRESSED AIR :..... 58 psi
CONSUMPTION OF AIR :..... 32 L/min

2. Connect the solenoid outlet to the vacuum generator with a plastic tube of 3/8".
3. Connect the distillate collection tank to the vapor condenser utilizing a rubber anti-solvent tube, avoiding any bend downwards.
4. When distilling flammable solvents, connect the distillate container to the grounding clip.
5. Turn off the distillate-unloading valve.

STARTING OPERATIONS

NOTE : During vacuum distillation some solvents foam with a consequent pollution of the distillate and vapors may leak from the cover.

The problem can be eliminated as follows :

- Utilize anti-foam discs.
- Reduce about 20% of the loading of solvent to be distillate.
- Reduce the compressed air pressure at the vacuum pump. In that way the vacuum will be reduced.
- Reduce the working temperature.
- Wait at least 48 hours after utilizing the solvent before starting the next distillation.

When filling up, pay attention not to pour solvent into the vapor manifold. The first solvent can come out dirty.



SR30V – OPTIONAL VACUUM DISTILLATION

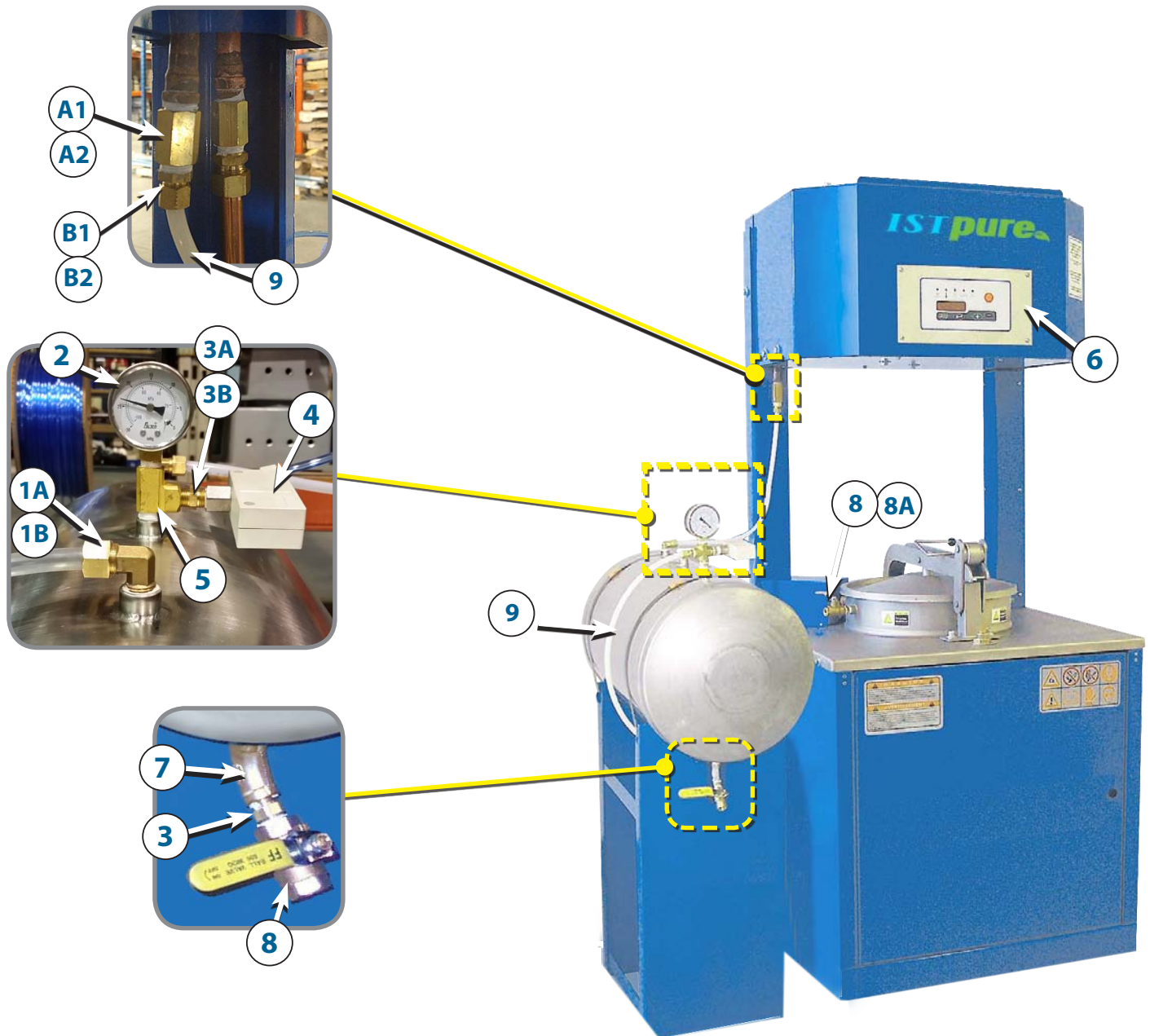

Nb	PART #	DESCRIPTION	Qty
A1	323166	3/8" PL NPT BRASS FITTING	1
A2	323501	1/2" PL NPT S/S FITTING	1
B1	323127	3/8" OD PL TUBE - 3/8" BRASS COMP. FITTING	1
B2	323208	3/8" OD PL TUBE - 1/2" S/S COMP. FITTING	1
1A	323131	1/4" OD PL TUBE - 3/8" BRASS COMP. FITTING	1
1B	323109	1/4" OD PL TUBE - 3/8" S/S COMP. FITTING	1
2	324001	VACUUM GAUGE	1
3A	632202	1/4" BRASS NIPPLE	5

Nb	PART #	DESCRIPTION	Qty
6	307003	KEYBOARD	2
7A	323190	1/4" @ 45° BRASS ELBOW	1
7B	323518	1/4" @ 45° S/S ELBOW	1
8A	323006	1/4" BRASS BALL VALVE	1
8B	323193	1/4" S/S BALL VALVE	1
9	324512	3/8" NYLON HOSE (2 FEET ON VACUUM & 4 FEET ON RECYCLER)	6



SR60V - OPTIONAL VACUUM DISTILLATION

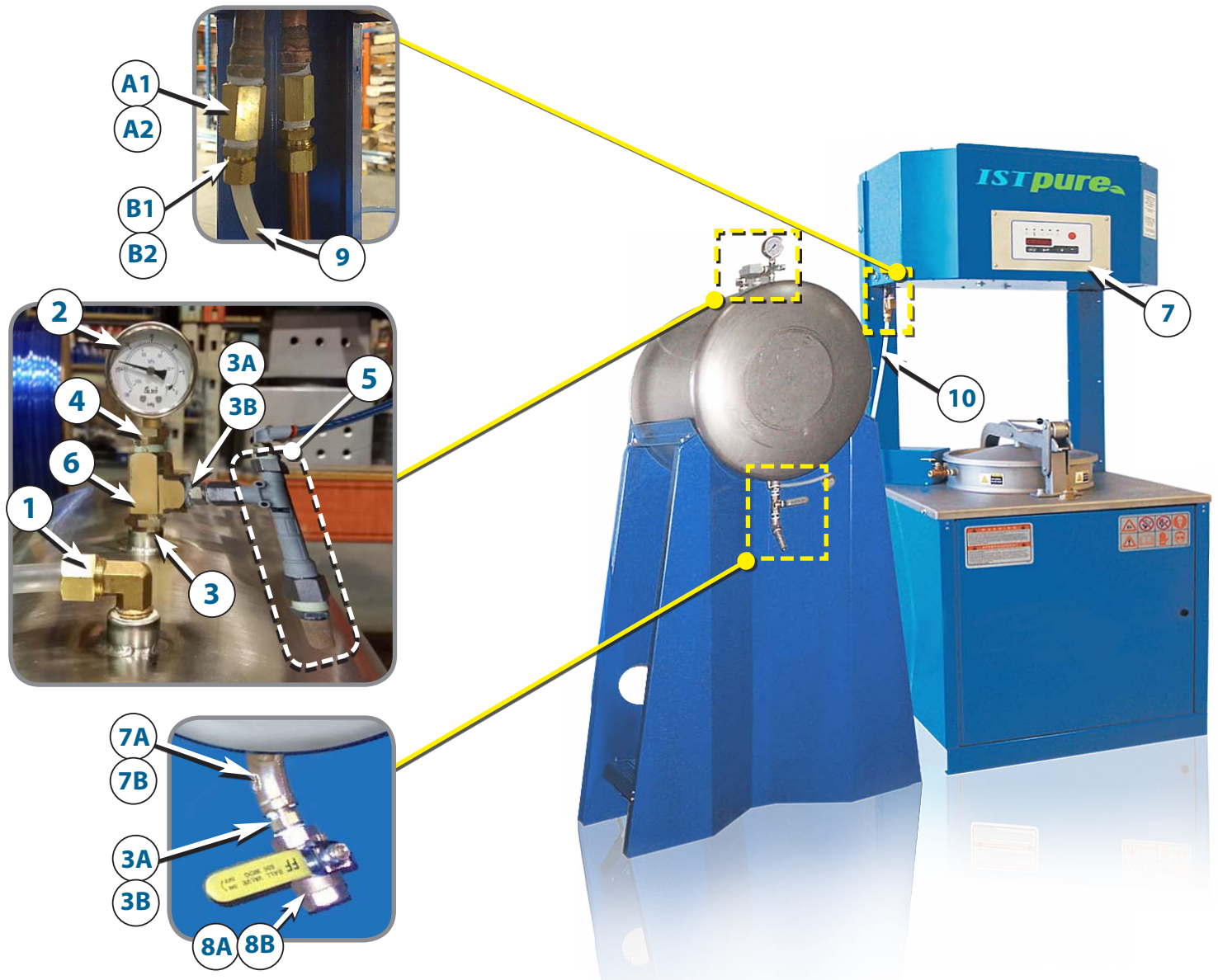

N°	N° PIÈCE	DESCRIPTION	Qté	N°	N° PIÈCE	DESCRIPTION	Qté
A1	632715	1/2" PL NPT BRASS NIPPLE	1	5	314026	VACUUM GENERATOR	1
A2	323501	1/2" PL NPT S/S NIPPLE	1	6	323170	1/2" "T"	1
B1	323169	3/8" PL OD TUBE COMP. BRASS FITTING - 1/2" M	1	7	307003	KEYBOARD	1
B2	323209	3/8" PL OD TUBE COMP. S/S FITTING - 1/4" M	1	7A	323189	1/4" @ 45° BRASS ELBOW	1
C	323206	1/2" M HEX. RED. - 1/4" F (FOR S/S ONLY)	1	7B	323517	1/4" @ 45° S/S ELBOW	1
1A	323131	1/4" NPT X 3/8" 90° BRASS COMP. FITTING	1	8A	608102	1/2" BRASS BALL VALVE	1
1B	323209	1/4" NPT X 3/8" 90° S/S COMP. FITTING	1	8B	908117	1/2" S/S BALL VALVE	1
2	324001	VACUUM GAUGE	1	9A	323169	1/4" X 3/8" STRAIGHT BRASS COMP. FITTING	2
3	632791	3/4" @ 1/2" ADAPTOR	1	9B	323209	1/4" X 3/8" STRAIGHT S/S COMP. FITTING	2
3A	632706	1/2" BRASS NIPPLE	1	10	324512	3/8" NYLON HOSE (2 FEET ON VACUUM & 4 FEET ON RECYCLER)	6'
3B	323511	1/2" S/S NIPPLE	1				
4	632745	1/2" @ 1/4" ADAPTOR	1				



OPTIONAL VACUUM INSTALLATION

Solenoid valve

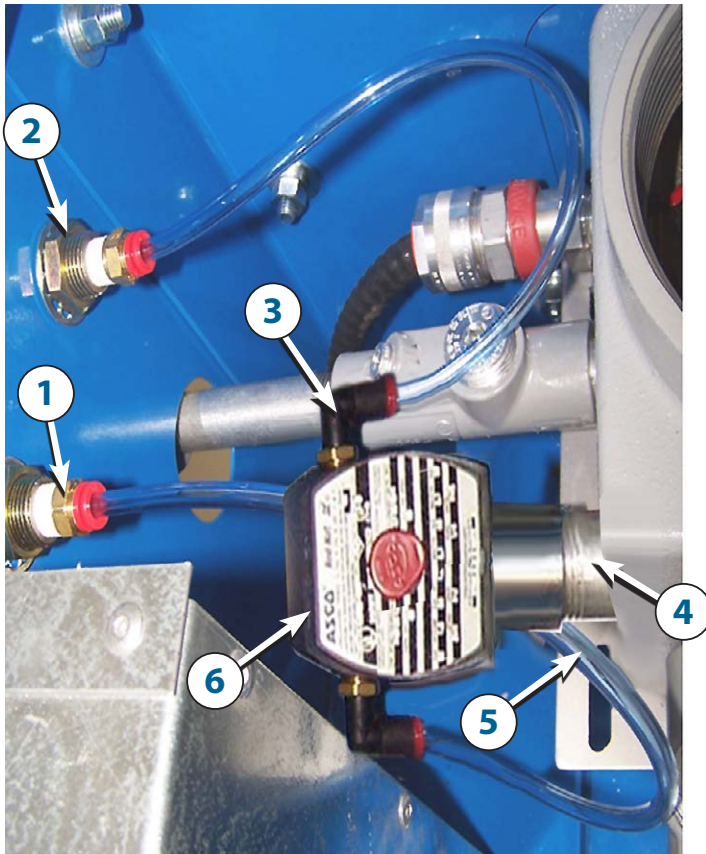

Nb	PART	DESCRIPTION	Qty
1	325503	1/4" FNTP X 1/4" OD PUSH-IN BULKHEAD FITTING	2
2	324502	1/4" OD X 1/4" OD PUSH-IN BULKHEAD FITTING	2
3	324560	1/4" @ 90° PUSH-IN FITTING	4
4	322013	1/2" ALUMINIUM NIPPLE	1
5	324571	1/4" POLY. HOSE (SOLD BY FOOT)	6.5
6	324003	SOLENOID VALVE	1

Default Vacuum Switch ass'y

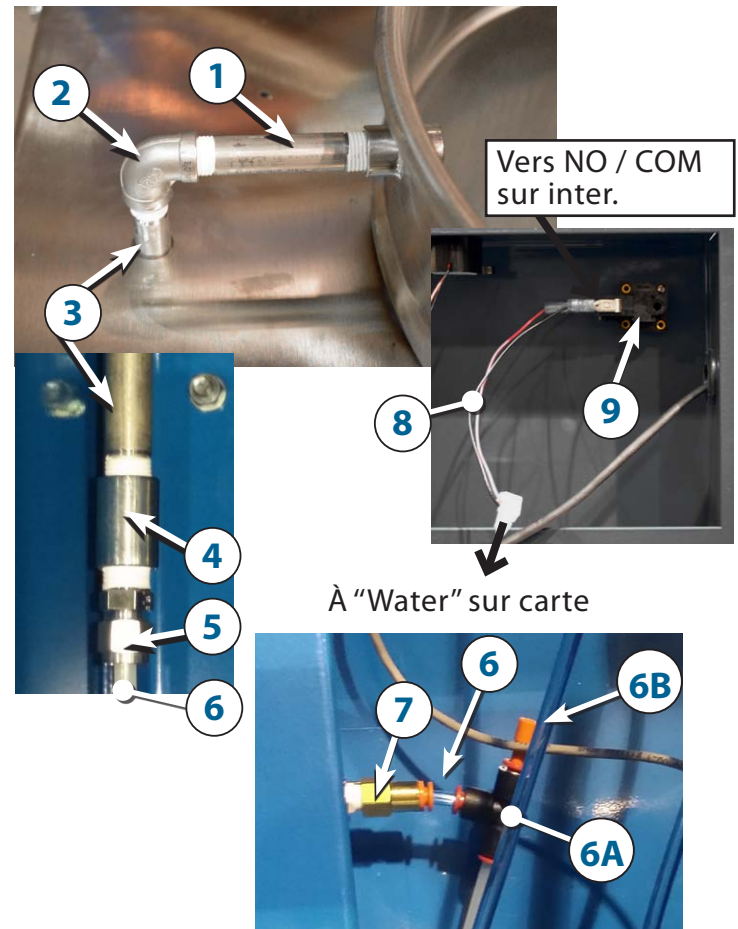

Nb	PART #	DESCRIPTION	Qty
1	323508	1/4" x 3" LG. S/S NIPPLE	1
2	323555	1/4" S/S 90° ELBOW	1
3	323507	1/4" x 6" S/S NIPPLE	1
4	323502	UNION	1
5	323239	HOSE CONNECTOR 1/4"	1
6	325255	WHITE HOSE PVC 1/4"	± 7'
6A	324584	"T" 1/4" PUSH-IN FITTING	1
6B	324504	1/4" PUSH-IN PERFORATED PLUG	1
7	324573	1/4" BULKHEAD UNION FITTING	1
8	NPN	CABLE SWITCH	1
9	314086	DEFAULT VACUUM SWITCH	1



Nb	PART #	DESCRIPTION	Qty
1	311002	REGULATOR GAUGE	1
2	324562	REGULATOR	1
3	324502	1/4" BULKHEAD UNION FITTING	1



AUTOMATIC FILLING AND SOLVENT TRANSFER SYSTEM (OPTIONAL)

The automatic filling system uses a diaphragm pump and a dirty solvent pump (optional on SR30 and SR60) to transfer spent solvent into the kettle. The process is controlled by a high level switch inside the kettle and is assisted by the software fill timer. The solvent transfer hose assembly is equipped with a filter to facilitate the transfer of clean and used solvent. It requires a diaphragm pump to operate.

HOW IT WORKS

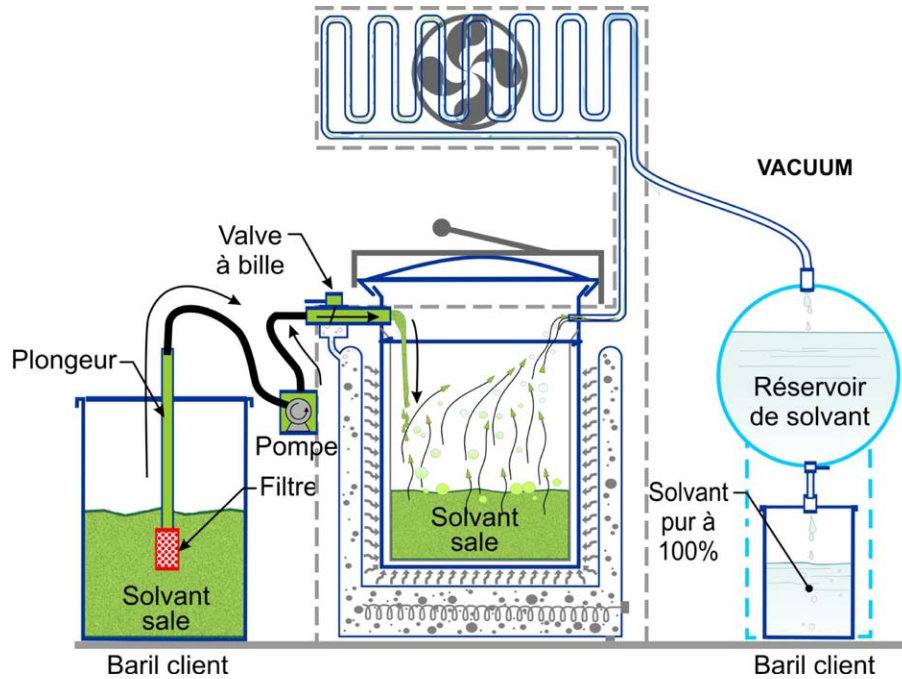

KEYBOARD COMMANDS

APPUYEZ	INDICATION	RÉSULTAT DU CLAVIER
	<p>Appuyez sur la touche «START / STOP», la lampe témoin «ON» va s'allumer.</p> <p>Les éléments électriques commenceront le chauffage de l'huile thermique.</p> <p>La lampe témoin «élément» va s'allumer.</p>	
	<p>le signal FILL va s'afficher.</p> <p>Assurez-vous que le valve de chargement solvant sale est sur la position ON</p> <p>Appuyez sur la flèche pour confirmer que vous voulez remplir l'unité.</p> <p>La pompe va commencer à remplir le recycleur jusqu'à ce que l'unité atteigne le niveau du capteur</p> <p>Le témoin ON va s'allumer</p> <p>L'élément électrique va commencer à chauffer l'huile thermique.</p> <p>Le témoin élément va s'allumer</p>	



DOUBLE DIAPHRAGM PUMP MODEL A050 M 1/2"

CAUTIONS & WARNINGS

READ THESE WARNINGS AND SAFETY PRECAUTIONS PRIOR TO INSTALLATION OR OPERATION. FAILURE TO COMPLY WITH THESE INSTRUCTIONS COULD RESULT IN PERSONAL INJURY AND OR PROPERTY DAMAGE. RETAIN THESE INSTRUCTIONS FOR FUTURE REFERENCE.

WARNING This product can expose you to chemicals including Nickel, Chromium, Cadmium, or Cobalt, which are known to the State of California to cause cancer and/or birth defects or other reproductive harm. For more information, go to www.P65Warnings.ca.gov.

WARNING Pump, valves and all containers must be properly grounded prior to handling flammable fluids and/or whenever static electricity is a hazard.

WARNING Prior to servicing the pump, ensure that the air and fluid lines are closed and disconnected. While wearing personal protective equipment, flush, drain and process liquid from the pump in a safe manner.

WARNING The TX marking refers to the maximum surface temperature depending not on the equipment itself, but mainly on operating conditions. In this case, the maximum surface temperature depends upon the temperature of the process fluids.

CAUTION The temperature of the process fluid and air input must be no more than 36°F (20C) less of the maximum temperature allowed for the appropriate non-metallic material. See the list of temperatures below for each material's maximum recommended temperature:

Buna-N (Nitrile):	10°F to 180°F (-12C to 82C)
Geolast®:	10°F to 180°F (-12C to 82C)
EPDM:	-40°F to 280°F (-40C to 138C)
Santoprene®:	-40°F to 225°F (-40C to 107C)
Viton® (FKM):	-40°F to 350°F (-40C to 177C)
PTFE:	40°F to 220°F (4C to 104C)
Polyethylene:	32°F to 158°F (0C to 70C)
Polypropylene:	32°F to 180°F (0C to 82C)
PVDF:	0°F to 250°F (-18C to 121C)
Nylon:	0°F to 200°F (-18C to 93C)

Temperature limits are solely based upon mechanical stress and certain chemicals will reduce the maximum operating temperature. The allowable temperature range for the process fluid is determined by the materials in contact with the fluid being pumped. Consult a chemical resistance guide for chemical compatibility and a more precise safe temperature limit. Always use minimum air pressure when pumping at elevated temperatures.

WARNING = Hazards or unsafe practices which could result in severe personal injury, death or substantial property damage

CAUTION = Hazards or unsafe practices which could result in minor personal injury, product or property damage.

CAUTION Do not lubricate air supply.

CAUTION Do not connect a compressed air source to the exhaust port of the pump.

WARNING Use only with liquid process fluid.

WARNING Maintenance must not be performed when a hazardous atmosphere is present.

CAUTION Do not exceed 120 psig (8.3 bar) air-inlet pressure.

CAUTION Do not exceed 10 psig (0.7 bar) or 23 ft-H₂O suction pressure.

CAUTION Ensure all wetted components are chemically compatible with the process fluid and the cleaning fluid.

CAUTION Ensure pump is thoroughly cleaned and flushed prior to installation into a process line.

CAUTION Always wear Personal Protective Equipment (PPE) when operating pump.

CAUTION Close and disconnect all compressed air and bleed all air from the pump prior to service. Remove all process fluid in a safe manner prior to service.

CAUTION Blow out all compressed air lines in order to remove any debris, prior to pump installation. Ensure that the muffler is properly installed prior to pump operation.

CAUTION Ensure air exhaust is piped to atmosphere prior to a submerged installation.

CAUTION Ensure all hardware is set to correct torque values prior to operation.



DOUBLE DIAPHRAGM PUMP MODEL A050 M 1/2"

MODEL DESIGNATION MATRIX & REPAIR KITS-BOLTED PLASTIC

PRODUCT SERIES	SIZE				LIQUID CONNECTION TYPE			LIQUID SECTION			DIAPHRAGM				VALVE/BALL			VALVE SEAT				O-RINGS				SPECIAL (HARDWARE, MUFFLER, LUG) PORTING			SPECIAL (OTHER)		
A	0	5	0	-	1	2	3	-	4	5	6	7	-	8	9	10	-	8	9	10											
																				1 FLUID CONNECTION TYPE			6 VALVE SEAT			9 SPECIAL OPTION (HARDWARE, MUFFLER, LUG)					
																				N = NPT B = BSPT 1 = Dual Suction / Dual Discharge NPT			P = Polypropylene 3 = Stainless Steel A = Aluminum Y = Nylon			3 = Standard (Zinc Plated Steel Hardware, Plastic Muffler) 4 = Zinc Plated Steel Hardware, Metal Muffler 7 = Stainless Steel Hardware, Plastic Muffler 8 = Stainless Steel Hardware, Metal Muffler B = PTFE Coated Stainless Steel Hardware, Plastic Muffler C = PTFE Coated Stainless Steel Hardware, Metal Muffler D = Zinc Plated Steel Hardware, Plastic Muffler, Grounding Lug Installed E = Zinc Plated Steel Hardware, Metal Muffler, Grounding Lug Installed F = Stainless Steel Hardware, Plastic Muffler, Grounding Lug Installed G = Stainless Steel Hardware, Metal Muffler, Grounding Lug Installed H = PTFE Coated Stainless Steel Hardware, Plastic Muffler, Grounding Lug Installed I = PTFE Coated Stainless Steel Hardware, Metal Muffler, Grounding Lug Installed					
																				2 AIR SECTION			7 O-RINGS			10 SPECIAL OPTION (OTHER)					
																				A = Aluminum, Pneumatic Shift P = Polypropylene, Pneumatic Shift			E = EPDM N = Buna-N T = PTFE V = Viton*			0 = Standard (None) 1 = Cycle Counter Valve 2 = Solenoid Adaptor Valve 110/50 Volt AC, 120/60 Volt AC, DIN 43650B Connector 3 = Solenoid Adaptor Valve 110/50 Volt AC, 120/60 Volt AC Explosion Proof 4 = Solenoid Adaptor Valve 220/50 Volt AC, 240/60 Volt AC, 12 Volt DC, DIN 43650B Connector 5 = Solenoid Adaptor Valve 220/50 Volt AC, 240/60 Volt AC, 12 Volt DC Explosion Proof 6 = Solenoid Adaptor Valve 220/50 Volt AC, 240/60 Volt AC, 125 Volt DC, DIN 43650B Connector 7 = Solenoid Adaptor Valve 220/50 Volt AC, 240/60 Volt AC, 125 Volt DC Explosion Proof 8 = Solenoid Adaptor Valve 24 Volt DC, DIN 43650B Connector 9 = Solenoid Adaptor Valve 24 Volt DC, Explosion Proof A = Grease Free (No Lubrication Assembly)					
																				3 LIQUID SECTION			8 PORTING								
																				A = Aluminum			S = Standard (Suction Right / Discharge Right) A = Suction Center Front / Discharge Center Front B = Suction Center Front / Discharge Center Rear D = Suction Center Front / Discharge Right E = Suction Center Front / Discharge Left F = Suction Center Rear / Discharge Center Front G = Suction Center Rear / Discharge Center Rear I = Suction Center Rear / Discharge Right J = Suction Center Rear / Discharge Left K = Suction Bottom / Discharge Center Front L = Suction Bottom / Discharge Center Rear N = Suction Bottom / Discharge Right O = Suction Bottom / Discharge Left P = Suction Right / Discharge Center Front Q = Suction Right / Discharge Center Rear T = Suction Right / Discharge Left U = Suction Left / Discharge Center Front V = Suction Left / Discharge Center Rear X = Suction Left / Discharge Right 4 = All Ports Open (Standard ports will be left un-plugged) 6 = Dual Section End Ports / Dual Discharge End Ports 7 = All Ports on Pump Open - No Plugs Included								
																				4 DIAPHRAGMS											
																				G = Geolast S = Santoprené T = PTFE with Santoprene® Backup V = Viton*											
																				5 VALVE/BALL											
																				G = Geolast S = Santoprené T = PTFE V = Viton* 3 = Stainless Steel											

WET END REPAIR KIT

Wet end kits are available and consist of diaphragms, (back-up diaphragms if required), balls, seats and seat O-rings. See matrix below.

AIR END REPAIR KIT

Air end repair kit contains pilot sleeve assembly and main air valve.

PRODUCT SERIES	WET END REPAIR KIT			PUMP SIZE				DIAPHRAGM				VALVE/BALL				VALVE SEAT				O-RINGS				METALLIC WET END			
A	W	E	-	0	5	0	-	4	5	6	7	-	4	5	6	7	-	4	5	6	7	-	M				
																									AIR SECTION		
																									A = Aluminum P = Polypropylene (Glass Filled)		

Bold indicates recommended options

* Solenoid Adaptor Valves only available on select pump models with polypropylene intermediate



DOUBLE DIAPHRAGM PUMP MODEL A050 M 1/2"

PRINCIPLES OF OPERATION

HOW AN AIR OPERATED DOUBLE DIAPHRAGM PUMP WORKS

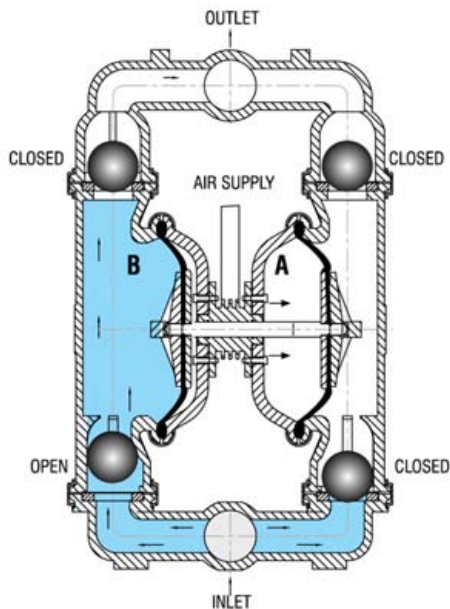

The air-valve directs pressurized air behind the diaphragm on the right, causing the diaphragm on the right to move outward (to the right).

Since both the right diaphragm and the left diaphragm are connected via a diaphragm rod, when the right diaphragm moves to the right, the left diaphragm (through the action of the diaphragm rod) moves to the right also.

When the diaphragm on the left side is moving to the right, it is referred to as suction stroke. When the left diaphragm is in its suction stroke, the left suction ball moves upward (opens) and the left discharge ball moves downward (closes). This action creates suction and draws liquid into the left side chamber.

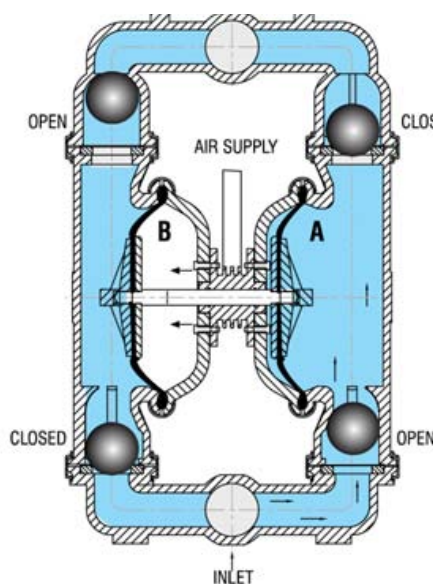

The air-valve directs pressurized air behind the left diaphragm, causing the left diaphragm to move outward (to the left).

Since both the left diaphragm and the right diaphragm are connected via a diaphragm rod, when the left diaphragm moves to the left, the right diaphragm (through the action of the diaphragm rod) moves to the left also.

When the diaphragm on the left side moves outward, the left discharge ball moves upward (opens) and the left suction ball moves downward (closes). This causes the liquid to leave the left side liquid outlet of the pump.

Simultaneously, the right diaphragm moves inward (to the left), which causes the right suction ball to open and the right discharge to close, which in turn causes suction, drawing liquid into the right chamber.

The process of alternating right suction / left discharge (and vice-versa) continues as long as compressed air is supplied to the pump.



DOUBLE DIAPHRAGM PUMP MODEL A050 M 1/2"

1/2" PUMP DIMENSIONS

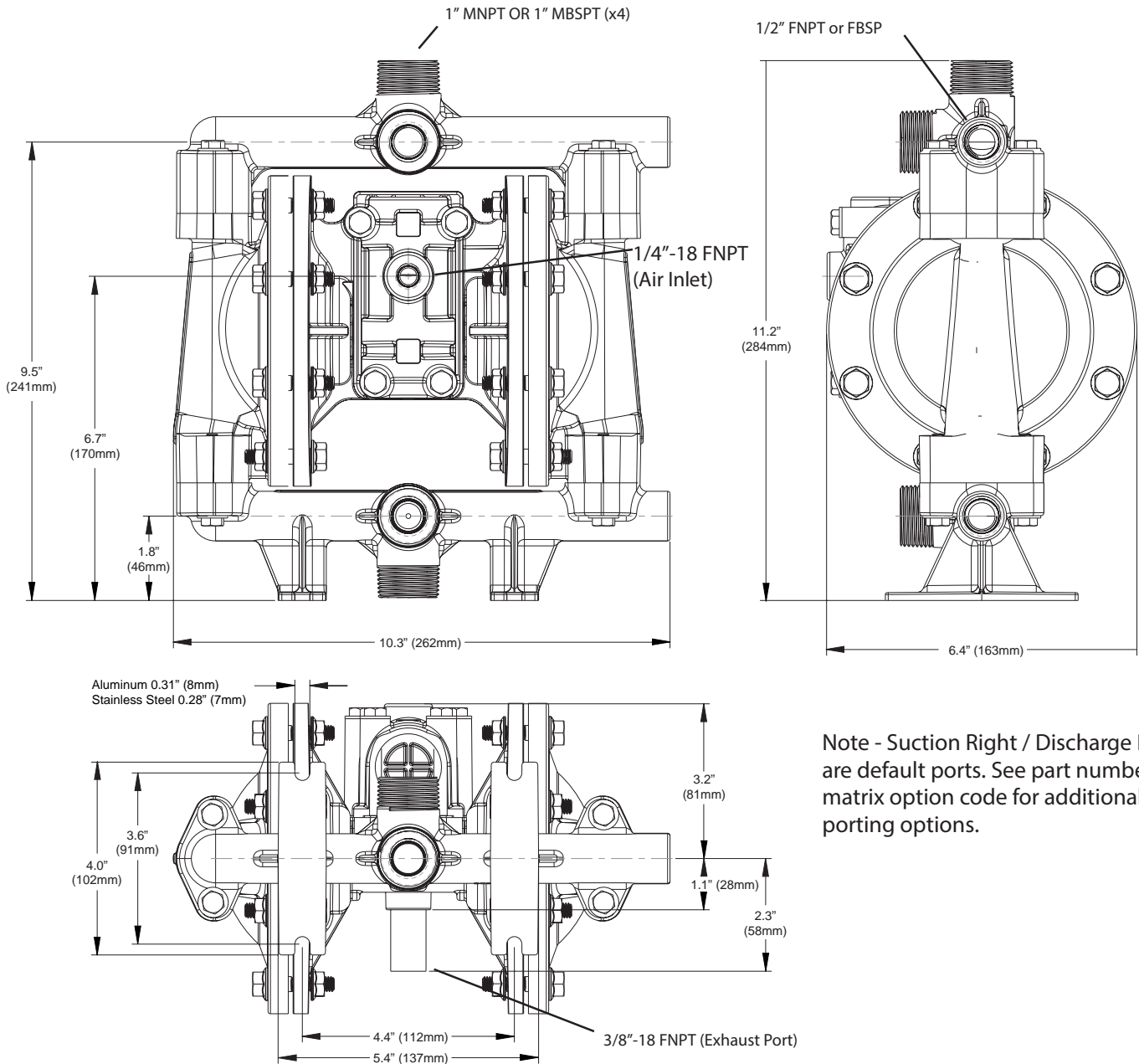



DOUBLE DIAPHRAGM PUMP MODEL A050 M 1/2"

PERFORMANCE CURVES

PERFORMANCE CURVE (1/2" RUBBER)*

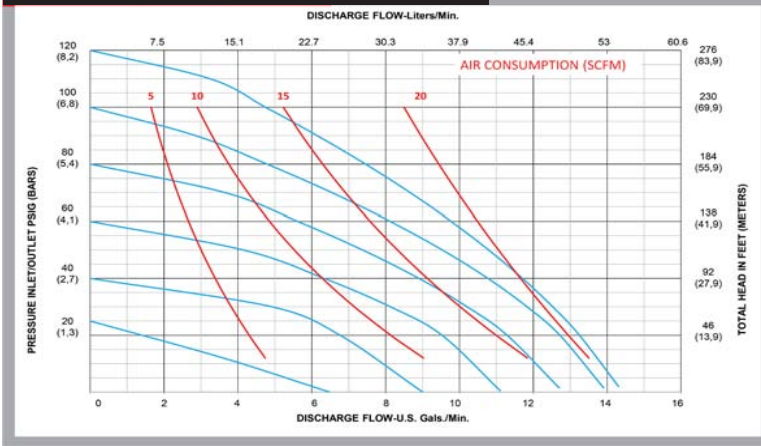

Performance Specifications

Max. Flow:	14 gpm (53.0 lpm)
Max. Air Pressure:	120 psi (8.3 bar)
Max. Solids:	1/8" (3.2 mm)
Max. Suction Lift Dry:	15 ft-H ₂ O (4.5 m-H ₂ O)
Max. Suction Lift Wet:	31 ft-H ₂ O (9.4 m-H ₂ O)
Weight:	AL-10 lbs (4.5 kg)/SS-20 lbs (9.1 kg)
Air Inlet:	1/4" FNPT
Liquid Inlet:	1/2" FNPT/BSPT
Liquid Outlet:	1/2" FNPT/BSPT
Height:	11.2" (284 mm)
Width:	10.3" (262 mm)
Depth:	6.4" (163 mm)**

PERFORMANCE CURVE (1/2" TPE)*

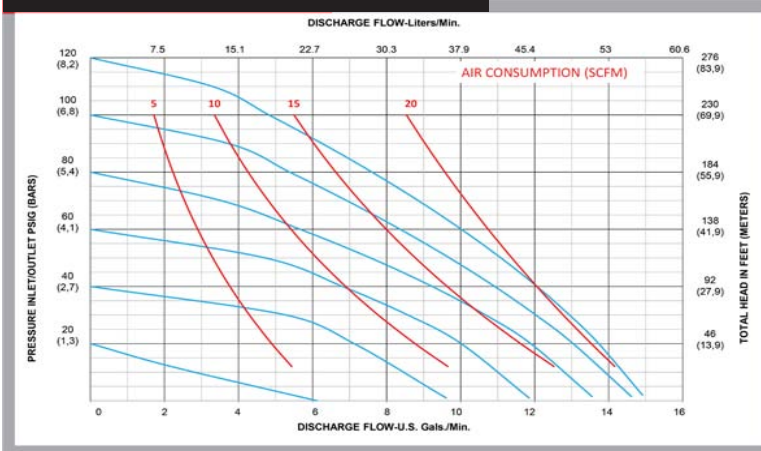

Performance Specifications

Max. Flow:	15 gpm (56.8 lpm)
Max. Air Pressure:	120 psi (8.3 bar)
Max. Solids:	1/8" (3.2 mm)
Max. Suction Lift Dry:	15 ft-H ₂ O (4.5 m-H ₂ O)
Max. Suction Lift Wet:	31 ft-H ₂ O (9.4 m-H ₂ O)
Weight:	AL-10 lbs (4.5 kg)/SS-20 lbs (9.1 kg)
Air Inlet:	1/4" FNPT
Liquid Inlet:	1/2" FNPT/BSPT
Liquid Outlet:	1/2" FNPT/BSPT
Height:	11.2" (284 mm)
Width:	10.3" (262 mm)
Depth:	6.4" (163 mm)**

PERFORMANCE CURVE (1/2" PTFE)*

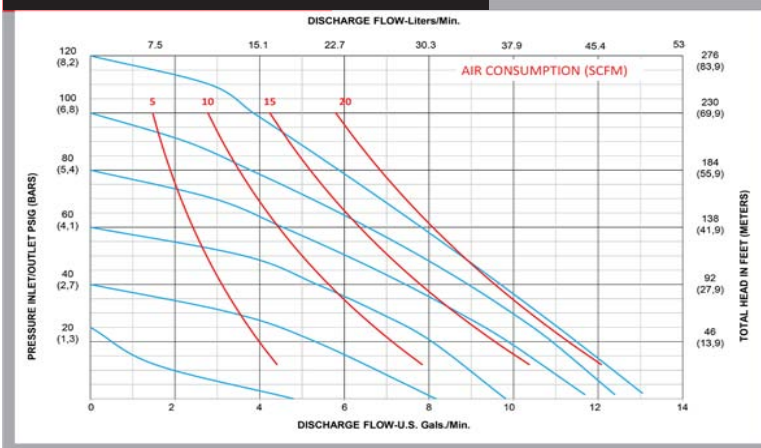

Performance Specifications

Max. Flow:	13 gpm (49.2 lpm)
Max. Air Pressure:	120 psi (8.3 bar)
Max. Solids:	1/8" (3.2 mm)
Max. Suction Lift Dry:	10 ft-H ₂ O (3.05 m-H ₂ O)
Max. Suction Lift Wet:	31 ft-H ₂ O (9.4 m-H ₂ O)
Weight:	AL-10 lbs (4.5 kg)/SS-20 lbs (9.1 kg)
Air Inlet:	1/4" FNPT
Liquid Inlet:	1/2" FNPT/BSPT
Liquid Outlet:	1/2" FNPT/BSPT
Height:	11.2" (284 mm)
Width:	10.3" (262 mm)
Depth:	6.4" (163 mm)**

*Flow rates indicated on all three charts shown were determined by pumping water at flooded suction, using an aluminum intermediate fitted pump. For optimum life and performance, pumps should be specified so that daily operation parameters will fall in the center of the pump performance curve.

**Polypropylene intermediate is 7.3" (185mm) deep.



DOUBLE DIAPHRAGM PUMP MODEL A050 M 1/2"

INSTALLATION

PIPING

Whenever possible ensure the pump is installed using the shortest possible pipe lengths with the minimum amount of pipe fittings. Ensure all piping is supported independent of the pump.

Suction and discharge piping should not be smaller than the connection size of the pump. When pumping liquids of high viscosity, larger piping may be used, in order to reduce frictional pipe loss.

Employ flexible hoses in order to eliminate the vibration caused by the pump. Mounting feet can also be used to reduce vibration effects.

All hoses should be reinforced, non-collapsible and be capable of high vacuum service. Ensure that all piping and hoses are chemically compatible with the process and cleaning fluid.

For processes where pulsation effects should be reduced, employ a pulsation dampener on the discharge side of the pump.

For self-priming applications, ensure all connections are airtight and the application is within the pumps dry-lift capability. Refer to product specifications for further details.

For flooded suction applications, install a gate valve on the suction piping in order to facilitate service.

For unattended flooded suction operation, it is recommended to pipe the exhaust air above the liquid source. In the event of a diaphragm failure this will reduce or eliminate the possibility of liquid discharging through the exhaust onto the ground.

LOCATION

Ensure that the pump is installed in an accessible location, in order to facilitate future service and maintenance.

AIR

Ensure that the air supply is sufficient for the volume of air required by the pump. Refer to product specifications for further details. For reliable operation, install a 5 micron air filter, air-valve and pressure regulator. Do not exceed the pumps maximum operating pressure of 120 psig.

REMOTE OPERATION

Utilize a three way solenoid valve for remote operation. This ensures that air between the solenoid and the pump is allowed to "bleed off," ensuring reliable operation. Liquid transfer volume is estimated by multiplying displacement per stroke times the number of strokes per minute.

NOISE

Correct installation of the muffler reduces sound levels. Refer to product specifications for further details.

SUBMERGED OPERATION

For submersible operation, pipe the air exhaust to atmosphere.

GROUNDING THE PUMP

Loosen grounding screw and install a grounding wire. Tighten grounding screw. Wire size should be a 12 gauge wire or larger. Connect the other end of the wire to a true earth ground. Equipment must be grounded to achieve ATEX rating and it is recommended to configure the pump with a grounding lug option.

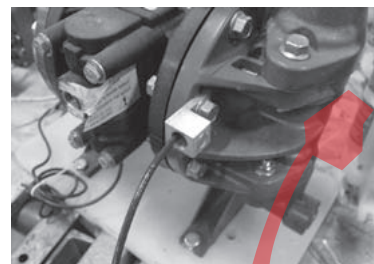



DOUBLE DIAPHRAGM PUMP MODEL A050 M 1/2"

TROUBLESHOOTING

PROBLEM	EFFECT/SOLUTION
Pump Will Not Cycle	<ul style="list-style-type: none"> Discharge line closed or plugged Discharge filter blocked Check valve stuck Air filter blocked Air supply valve closed Air supply hooked up to muffler side of pump Compressor not producing air or turned off Muffler iced or blinded Diaphragm ruptured Plant air supply line ruptured Air valve wear/debris Pilot sleeve wear/debris Diaphragm rod broken Diaphragm plate loose
Pumped Fluid Coming Out of Muffler	<ul style="list-style-type: none"> Diaphragm ruptured Diaphragm plate loose Inlet liquid pressure excessive (above 10 psig)
Pump Cycles but no Flow	<ul style="list-style-type: none"> Inlet strainer clogged Suction valve closed Suction line plugged No liquid in the suction tank Suction lift excessive Debris stuck in valves Excessive wear of check valves Air leak on suction side with suction lift
Pump Cycles with Closed Discharge Valve	<ul style="list-style-type: none"> Debris stuck in check valve Excessive wear of check valves
Pump Running Slowly/Not Steady	<ul style="list-style-type: none"> Air compressor undersized Leak in air supply Air-line, filter regulator or needle valve undersized Muffler partially iced or blinded Air valve gasket leak or misalignment Air valve wear/debris Pilot sleeve wear/debris Liquid fluid filter blocked Pump may be cavitating, reduce speed of operation Suction strainer clogged
Pump Will Not Prime	<ul style="list-style-type: none"> Air leak in suction pipe Air leak in pump manifold connections Suction strainer and lines clogged Excessive lift conditions Check valve wear Debris in check valve



DOUBLE DIAPHRAGM PUMP MODEL A050 M 1/2"

OPERATIO & MAINTENANCE

OPERATION

The Air-Operated Double Diaphragm Pump requires a minimum of 20 psig of air to operate, with some variation according to diaphragm material. Increasing the air pressure results in a more rapid cycling of the pump and thus a higher liquid flow rate. In order to not exceed 120 psig of inlet air pressure, and for accurate control of the pump, it is suggested to use a pressure regulator on the air inlet.

An alternate means of controlling the flow-rate of the pump is to use an inlet air valve and partially open or close accordingly. When the air valve is completely in the closed position, the pump will cease to operate.

A third method of controlling the flow rate of the pump is to use a liquid discharge valve. Closing the liquid discharge valve will cause a decrease in the flow rate since the pump will operate against a higher discharge pressure.

Solenoid control of the inlet air may also be used in order to facilitate remote operation. A three way solenoid valve is recommended, in order to allow the air to "bleed off" between the solenoid and the pump.

Do not use valves for flow control on the suction side of the pump. (Closing or partially closing a liquid suction valve restrict the suction line and may cause damage to the diaphragms.) Suction strainers may be employed to reduce or eliminate larger solids, but routine maintenance is necessary in order to prevent a restriction on the suction.

MAINTENANCE

Due to the unique nature of each application, periodic inspection of the pump is the best method to determine a proper maintenance schedule. A record should be kept of all repairs made to an installed pump. This will serve as the best predictor of future maintenance.

Typical maintenance involves replacing of "wear-parts" such as the diaphragms, balls, valve seats and O-rings. Proper maintenance can ensure trouble-free operation of the pump. Refer to repair and assembly instructions for further details.

 **WARNING** Maintenance must not be performed when a hazardous atmosphere is present.

MAINTENANCE SCHEDULE

WEEKLY (OR DAILY)

Make a visual check of the pump. If pumped fluid is leaking out of the pump, pipe fittings or muffler turn off pump and schedule maintenance.

EVERY THREE MONTHS

Inspect fasteners and tighten any loose fasteners to recommended torque settings.

Schedule pump service based on pump's service history.



DOUBLE DIAPHRAGM PUMP MODEL A050 M 1/2"

REPAIR AND ASSEMBLY : PUMP WET END REMOVAL

TOOLS NEEDED

- 1) One Wrench, 7/16 Inch
- 2) Two Wrenches, 1/2 Inch
- 3) Two Wrenches, 3/4 Inch
- 4) One Screwdriver, Slotted Head

! WARNING Prior to servicing the pump, ensure that the air and fluid lines are closed and disconnected. While wearing personal protective equipment, flush, drain and process liquid from the pump in a safe manner.

! WARNING Maintenance must not be performed when a hazardous atmosphere is present.

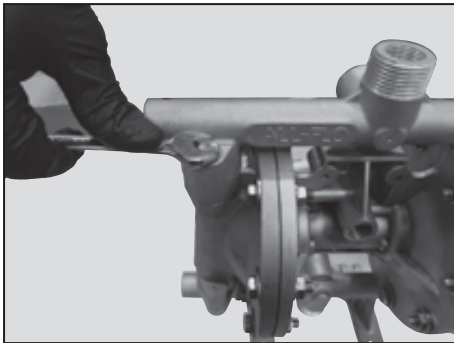

STEP 1

Using the 7/16 inch wrench remove four "Hex-Head Cap Screws (1/4"-20 x 1-3/4")" and four "Flat Washers (1/4")" from the "Discharge Manifold"

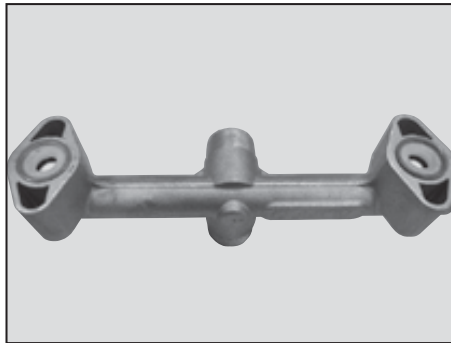

STEP 2

Remove the "Discharge Manifold".



STEP 3

Remove the "O-Ring", "Valve Seat" and "Ball" from the "Discharge Manifold".

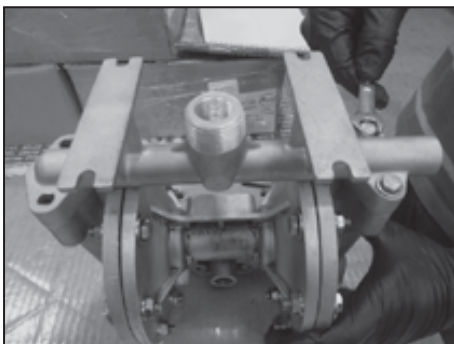

STEP 4

Using the 7/16 inch wrench remove four "Hex-Head Cap Screws (1/4"-20 x 1-3/4")" and four "Flat Washers (1/4")" from the "Suction Manifold".

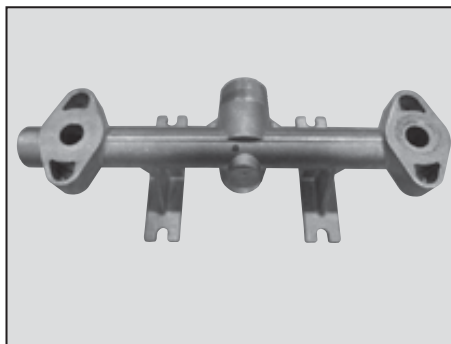

STEP 5

Remove the "Suction Manifold".

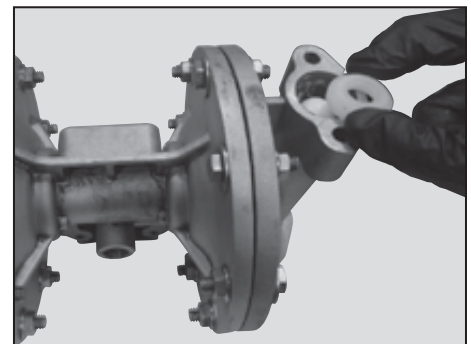

STEP 6

Remove the "O-Ring", "Valve Seat" and "Ball" from the "Suction Manifold".



DOUBLE DIAPHRAGM PUMP MODEL A050 M 1/2"

REPAIR AND ASSEMBLY : PUMP WET END (CONT'D)



STEP 7

In order to remove "Outer Chambers", using two 1/2 inch wrenches, remove eight "Hex Head Cap Screws (5/16"-18 x 1-3/4")", eight "Flat and Lock Washers (5/16")" and eight "Hex Flange Nuts (5/16"-18)" from each side.

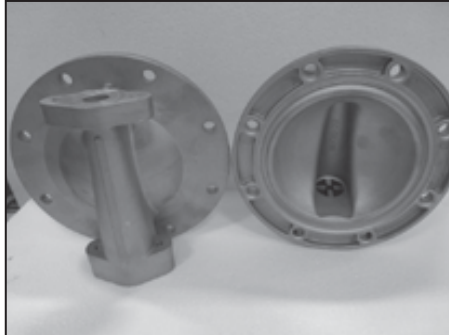

STEP 8

Remove both "Outer Chambers" from the "Intermediate".



STEP 9

Using two 3/4 Inch wrenches, remove "Outer Diaphragm Plate", "Diaphragm", "Inner Diaphragm Plate" and "Flat Washer (1/4")" from one side of the pump.



STEP 10

Placing the 3/4 inch wrench on the remaining "Outer Diaphragm Plate", and the 7/16 inch wrench on the "Diaphragm Rod Assembly", remove the remaining "Outer Diaphragm Plate", "Diaphragm", "Inner Diaphragm Plate" and "Flat Washer (1/4")" from the other side of the pump.



DOUBLE DIAPHRAGM PUMP MODEL A050 M 1/2"

REPAIR AND ASSEMBLY : AIR VALVE (CONT'D)

TOOLS NEEDED

- 1) One Wrench, $\frac{7}{16}$ Inch
- 2) One Pick, General Purpose
- 3) One Pair of Pliers

! WARNING Prior to servicing the pump, ensure that the air and fluid lines are closed and disconnected. While wearing personal protective equipment, flush, drain and process liquid from the pump in a safe manner.

! WARNING Maintenance must not be performed when a hazardous atmosphere is present.

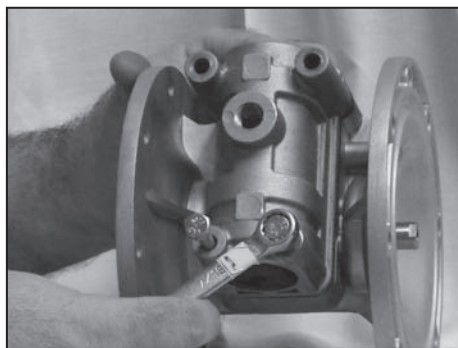

STEP 1

Using the $\frac{7}{16}$ inch wrench, remove four "Hex Head Cap Screws (1/4" - 20)", four "Lock Washers (1/4")" and four "Flat Washers (1/4")".



STEP 2

Remove the main "Air-Valve Assembly" from the pump.

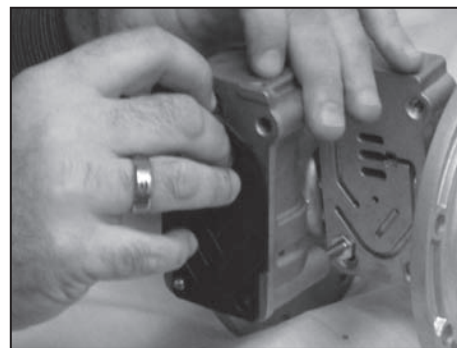

STEP 3

Remove the "Air-Valve Gasket" from the main "Air-Valve Assembly".

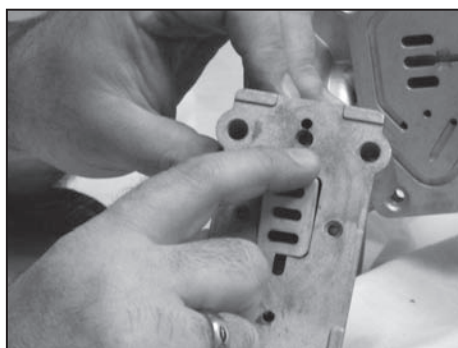

STEP 4

Remove the "Shuttle Plate" from the main "Air-Valve Assembly".

Note: The smooth shiny side of the shuttle plate should be toward the shuttle car.



STEP 5

Remove the "Shuttle" from the main "Air-Valve Assembly".



STEP 6

Using the pair of pliers, remove the "Air Valve End Plug" from the main "Air-Valve Assembly".

Ensure the "O-Ring" is installed when reassembling.



DOUBLE DIAPHRAGM PUMP MODEL A050 M 1/2"

REPAIR AND ASSEMBLY : AIR VALVE (END)



STEP 7

Remove the "Air Valve Spool" from the main "Air-Valve Assembly".

Note: Insert larger chamfer first. The smaller chamfer is to be on the plug side.

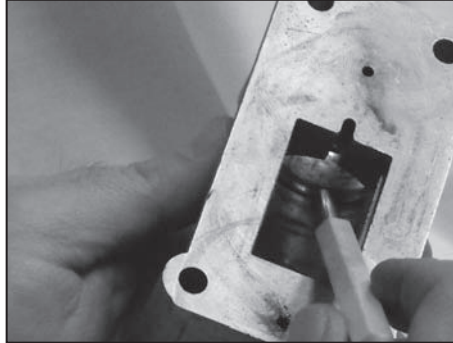

STEP 8

Using the pick, remove the "Lip Seal (Air Valve)" from the main "Air-Valve Assembly".

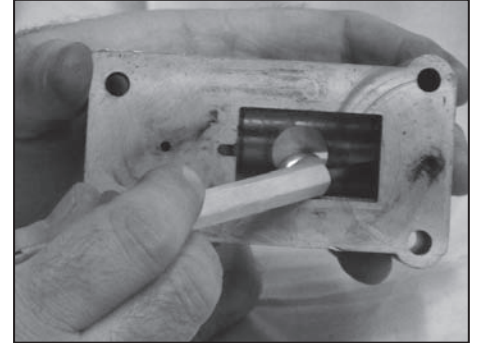

STEP 9

Using the pick, remove the second "Lip Seal (Air Valve)" from the main "Air-Valve Assembly".

AIR VALVE ASSEMBLY

To assemble the air valve, reverse the order of disassembly. During assembly, ensure that the open side of the lip-seals are both facing each other inward. Install the shuttle plate with the smooth/shiny side toward the shuttle car. Lubrication of the air valve assembly, with a non-synthetic lubricant, is recommended. Magna-Lube or Magna-Plate are recommended for assembly lubrication (see detailed parts list for ordering information).

Note that if the lip-seals are installed incorrectly, they will be unable to rotate. Insert the spool, larger chamfer first, smaller chamfer to be on the plug side (longer piston/smaller boss), ensure O-ring is installed and then the air-valve end plug into position.



DOUBLE DIAPHRAGM PUMP MODEL A050 M 1/2"

REPAIR AND ASSEMBLY : PILOT VALVE

REMOVAL

TOOLS NEEDED

- 1) One Screwdriver, #2 Phillips
- 2) Two Wrenches, 7/16 Inch

! WARNING Prior to servicing the pump, ensure that the air and fluid lines are closed and disconnected. While wearing personal protective equipment, flush, drain and process liquid from the pump in a safe manner.

! WARNING Maintenance must not be performed when a hazardous atmosphere is present.

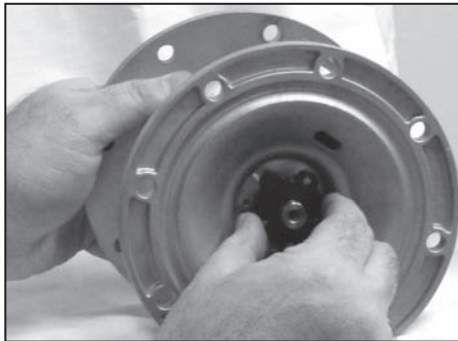

STEP 1

Using the screwdriver, remove three "Phillips Pan-Head Screws (#6-32)" in order to remove the "Retaining Plate". Repeat for both sides of the pump.



STEP 2

Remove the diaphragm rod and the pilot sleeve assembly from the "Intermediate".

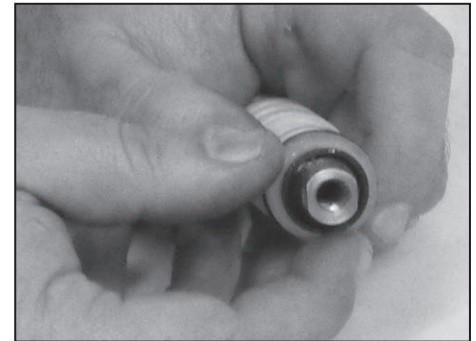

STEP 3

Remove both "Lip Seals (Diaphragm Rod)" and both "End Spacers (Pilot Sleeve)" from the pilot sleeve assembly. Remove both "O-Rings (End Spacer)" from both "End Spacers (Pilot Sleeve)".



STEP 4

Remove three "Inner Spacers (Pilot Sleeve)" and four "O-Rings (Pilot Sleeve)" from the pilot sleeve assembly.



STEP 5

Using two 7/16 inch wrenches, disassemble the "Diaphragm Rod Assembly" into its two parts.

Note: They are installed with thread locker.



STEP 6

Remove the "Pilot Sleeve" from the disassembled "Diaphragm Rod Assembly".



DOUBLE DIAPHRAGM PUMP MODEL A050 M 1/2"

REPAIR AND ASSEMBLY : PILOT VALVE

ASSEMBLY

To assemble the pilot valve, reverse the order of disassembly. Should process fluid have contact with the pilot valve O-Rings, they should be replaced as swelling may occur and cause irregular operation. During assembly, ensure that the open side of the lip-seals are facing outward.

Lubrication of the pilot sleeve assembly, with a non-synthetic lubricant, is recommended in order to facilitate re-assembly into the intermediate.

Magna-Lube or Magna-Plate are recommended for assembly lubrication (see detailed parts list for ordering information).

RECOMMENDED TORQUE SPECIFICATIONS

	1/2" Pumps	Wrench Size
Manifold Bolts	78 in-lb (8.8 N-m)	7/16"
Chamber Bolts	85 in-lb (9.6 N-m)	1/2"
Air Valve Bolts	40 in-lb (4.5 N-m)	7/16"
Diaphragm plate	70 in-lb (7.9 N-m)	3/4"
Diaphragm plate (PTFE)	70 in-lb (7.9 N-m)	3/4"



DOUBLE DIAPHRAGM PUMP MODEL A050 M 1/2"

EXPLODED VIEW

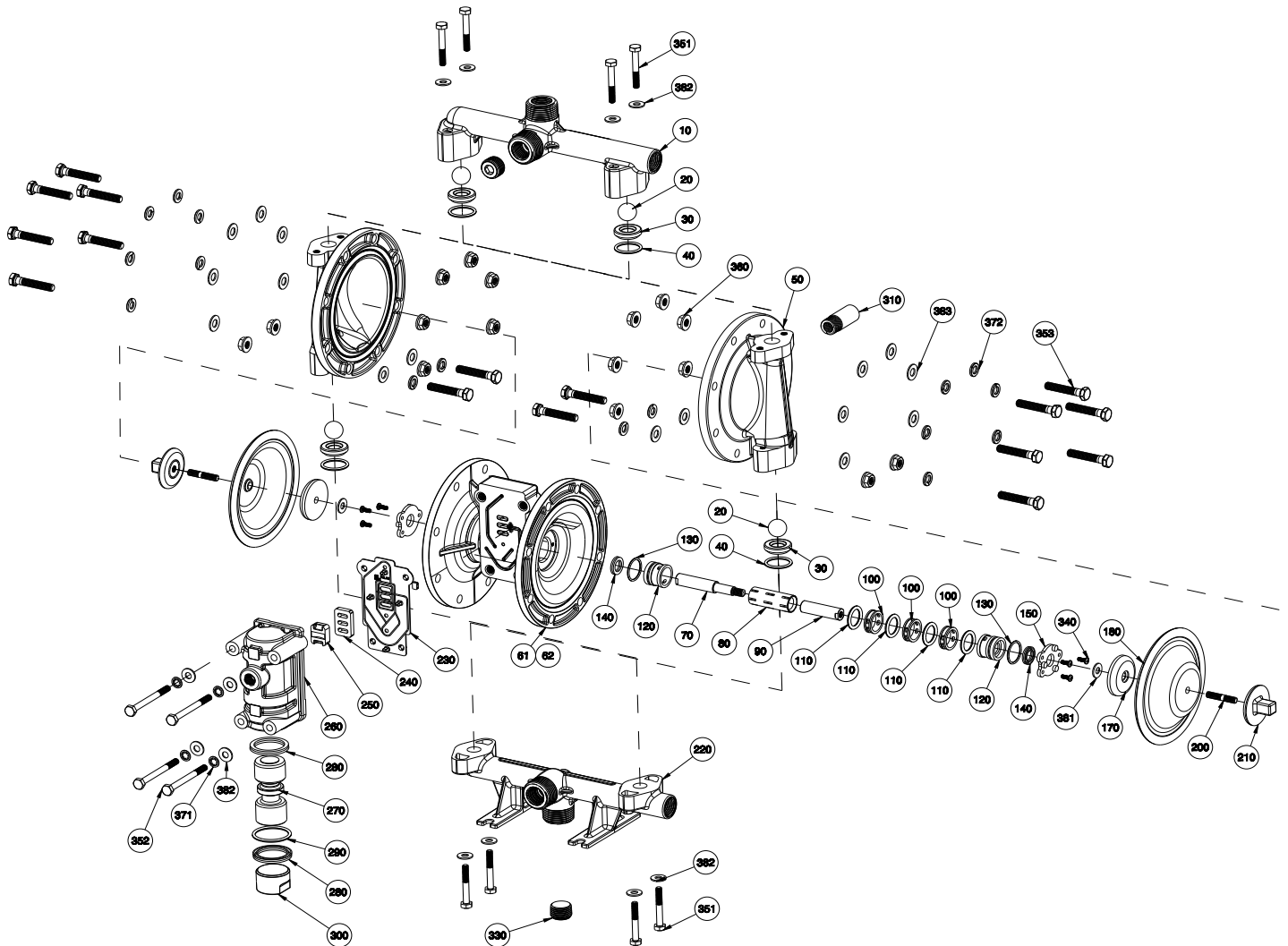
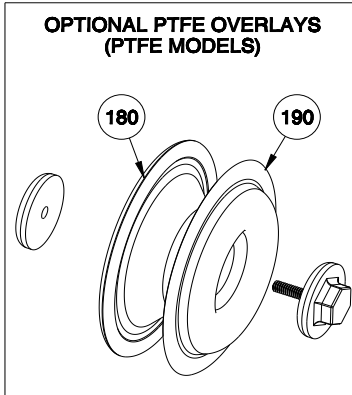



DOUBLE DIAPHRAGM PUMP MODEL A050 M 1/2"

PARTS LIST

ITEM	DESCRIPTION	QTY	PUMP MODEL	PART NO.	MATERIAL
10	DISCHARGE MANIFOLD	1	A050-N*A-****-0**	11329-20-NPT	Aluminum
			A050-B*A-****-0**	11329-20-BSPT	Aluminum
			A050-N*3-****-0**	11329-26-NPT	Stainless Steel
			A050-B*3-****-0**	11329-26-BSPT	Stainless Steel
20	BALL	4	A050-***.V***.***	11000-13 †	Viton® /FKM
			A050-***.G***.***	11000-19 †	Geolast®
			A050-***.S***.***	11000-23 †	Santoprene®
			A050-***.3***.***	11000-26 †	Stainless Steel
			A050-***.T***.***	11000-45 †	PTFE
30	VALVE SEAT	4	A050-***.A***.***	10900-20 †	Aluminum
			A050-***.3***.***	10900-26 †	Stainless Steel
			A050-***.P***.***	10900-40 †	Polypropylene
			A050-***.Y***.***	10900-42 †	Nylon
40	O-RING (VALVE SEAT)	4	A050-***.K***.***	10900-56 †	PVDF
			A050-***.N***.***	11904-11 †	Nitrile
			A050-***.V***.***	11904-13 †	Viton® /FKM
			A050-***.E***.***	11904-15 †	EPDM
40	O-RING (VALVE SEAT)	4	A050-***.T***.***	11904-17 †	PTFE
			A050-***.A***.***	10720-20	Aluminum
			A050-***.3***.***	10720-26	Stainless Steel
			A050-***.A***.***	11527-20	Aluminum
61 & 62	INTERMEDIATE	1	ALL MODELS	33000-00	Stainless Steel
70 & 90	DIAPHRAGM ROD ASSEMBLY	1	ALL MODELS	10105-31 Δ	Acetel
80	PILOT SLEEVE	1	ALL MODELS	10203-40 Δ	Polypropylene
100	INNER SPACER (PILOT SLEEVE)	3	ALL MODELS	11920-16 Δ	Urethane
110	O-RING (PILOT SLEEVE)	4	ALL MODELS	10204-40 Δ	Polypropylene
120	END SPACER (PILOT SLEEVE)	2	ALL MODELS	11923-11 Δ	Nitrile
130	O-RING (END SPACER)	2	ALL MODELS	12000-76 Δ	Nitrile
140	LIP SEAL (DIAPHRAGM ROD)	2	ALL MODELS	12708-54	Nylon
150	RETAINING PLATE	2	ALL MODELS		
160	N/A				
170	INNER DIAPHRAGM PLATE	2	ALL MODELS	11100-40	Polypropylene
180	DIAPHRAGM	2	A050-***.V***.***	10600-13 †	Viton® /FKM
			A050-***.G***.***	10600-19 †	Geolast®
			A050-***.N***.***	10600-21 †	Nitrile
			A050-***.S***.***	10600-23 †	Santoprene®
			A050-***.T***.***	10600-23 †	Santoprene®
190	OVERLAY (OPTIONAL)	2	A050-***.T***.***	11400-59 †	PTFE
200 & 210	OUTER DIAPHRAGM PLATE	2	A050-***.A***.***	11208-20	Aluminum
			A050-***.3***.***	11208-26	Stainless Steel
220	SUCTION MANIFOLD	1	A050-N*A-****-0**	11328-20-NPT	Aluminum
			A050-B*A-****-0**	11328-20-BSPT	Aluminum
			A050-N*3-****-0**	11328-26-NPT	Stainless Steel
			A050-B*3-****-0**	11328-26-BSPT	Stainless Steel
230	AIR VALVE GASKET	1	ALL MODELS	12126-19 ‡	Nitrile
240	SHUTTLE PLATE	1	ALL MODELS	10416-77 ‡	Ceramic
250	SHUTTLE	1	ALL MODELS	10415-00 ‡	Special
260	AIR VALVE BODY	1	A050-***.A***.***	42001-20 ‡	Aluminum
270	AIR VALVE SPOOL	1	ALL MODELS	10480-31 ‡	Acetel
280	LIP SEAL (AIR VALVE)	2	ALL MODELS	12003-76 ‡	Nitrile
290	O-RING (AIR VALVE END PLUG)	1	ALL MODELS	11913-11 ‡	Nitrile



DOUBLE DIAPHRAGM PUMP MODEL A050 M 1/2"

PARTS LIST (CONT'D)

ITEM	DESCRIPTION	QTY	PUMP MODEL	PART NO.	MATERIAL
300	AIR VALVE END PLUG	1	A050-*A*-*-*-*-*	11706-20 ‡	Aluminum
310	MUFFLER MUFFLER (METAL)	1	ALL MODELS Optional	13008-00 13002-00	Standard Metal
320	N/A				
330	PIPE PLUG	2	A050-N*A*-*-*-*-* A050-B*A*-*-*-*-* A050-N*3-*-*-*-* A050-B*3-*-*-*-*	12255-20-NPT 12255-20-BSPT 12255-26-NPT 12255-26-BSPT	Aluminum Aluminum Stainless Steel Stainless Steel
340	PAN-HEAD MACH SCREW (#6-32 x 7/16)	6	A050-**A*-*-*-*-*	12585-26	Stainless Steel
351	HEX HEAD CAP SCREW (1/4"-20 x 1-3/4")	8	A050-**A*-*-*-*-* A050-**3-*-*-*-*	12500-25 12500-26	Plated Steel Stainless Steel
352	HEX HEAD CAP SCREW (1/4"-20 x 2-3/4")	4	A050-**AA*-*-*-*-* A050-**A3*-*-*-*	12576-25 12576-26	Plated Steel Stainless Steel
353	HEX HEAD CAP SCREW (5/16-18 x 1-3/4")	16	A050-**A*-*-*-*-* A050-**3-*-*-*-*	12503-25 12503-26	Plated Steel Stainless Steel
360	HEX FLANGE NUT (5/16"-18)	16	A050-**A*-*-*-*-* A050-**3-*-*-*-*	12608-25 12608-26	Plated Steel Stainless Steel
371	LOCK WASHER (1/4")	4	A050-**A*-*-*-*-* A050-**3-*-*-*-*	12350-25 12350-26	Plated Steel Stainless Steel
372	WASHER, SPLIT LOCK (5/16")	16	A050-**A*-*-*-*-* A050-**3-*-*-*-*	12313-25 12313-26	Plated Steel Stainless Steel
381	WASHER (1/4")	2	ALL MODELS	12300-26	Stainless Steel
382	WASHER (1/4")	12 12	A050-**A*-*-*-*-* A050-**3-*-*-*-*	12300-25 12300-26	Plated Steel Stainless Steel
383	WASHER (5/16")	16	A050-**A*-*-*-*-* A050-**3-*-*-*-*	12310-25 12310-26	Plated Steel Stainless Steel
390	N/A				
400		1	OPTIONAL	13481-20	Aluminum
-/-	Magnalube® .75 oz. (As Required)	-/-	ALL MODELS	13404-00	Grease

* Any Character

‡ , Δ Only sold as part of assembly

ASSEMBLY PART NUMBERS	PUMP MODEL	PART NO.	MATERIAL
‡ AIR VALVE ASSEMBLY INCLUDES 230, 240, 250, 260, 270, 280, 290, 300	A050-*A*-*-*-*-*	AMK-050-A	Various
Δ PILOT SIEVE ASSEMBLY INCLUDES 80, 100, 110, 120, 130, 140	A050-*A*-*-*-*-*	APK-050-A	Various
† WET END REPAIR KIT 20, 30, 40, 180, 190	A050-*A*-*-*-*-*	AWE-050-****-M	Various



DOUBLE DIAPHRAGM PUMP MODEL A050 M 1/2"

WETTED ELASTOMERS

BUNA-N (NITRILE)

is a general purpose elastomer used with water and many oils. Temperature range 10°F to 180°F (-12C to 82C).

GEOLAST®

is an injection molded thermoplastic material with characteristics similar to Nitrile. Has excellent abrasion resistance. Temperature range 10°F to 180°F (-12C to 82C).

EPDM

is a general purpose elastomer with good resistance to many acids and bases. Temperature range -40°F to 280°F (-40C to 138C).

SANTOPRENE®

is an injection molded material with characteristics similar to EPDM. Has excellent abrasion resistance. Temperature range -40°F to 225°F (-40C to 107C).

VITON®

is an elastomer with good corrosion resistance to a wide variety of chemicals. Temperature range -40°F to 350°F (-40C to 177C).

FKM

is an elastomer with good corrosion resistance to a wide variety of chemicals. Similar in chemical resistance to Viton®. Temperature range -40°F to 350°F (-40C to 177C).

PTFE (POLYTETRAFLUOROETHYLENE)

is a thermoplastic polymer that is inert to most chemicals. Similar in chemical resistance to Teflon®. Temperature range 40°F to 220°F (4C to 104C).

Most of the above elastomers are available in FDA approved formulations.

Viton® is a registered trademark of DuPont Performance Elastomers L.L.C.
Geolast® is a registered trademark of ExxonMobil Chemical Co.
Santoprene® is a registered trademark of ExxonMobil Chemical Co.
Teflon® is a registered trademark of DuPont Performance Elastomers L.L.C.
Hytrel® is a registered trademark of DuPont Performance Elastomers L.L.C.
Magnalube® is a registered trademark of Carleton-Stuart Corp.



II 2 GD c TX

Warning: The TX marking refers to the maximum surface temperature depending not on the equipment itself, but mainly on operating conditions. In this case, the maximum surface temperature depends upon the temperature of the process fluids.



DOUBLE DIAPHRAGM PUMP MODEL A050 M 1/2"

WARRANTY AND REGISTRATION

All All-Flo products shall be covered by the standard All-Flo Limited Warranty in effect at the time of shipment. This warranty (which may be modified by All-Flo at any time) provides:

MATERIALS SOLD ARE WARRANTED TO THE ORIGINAL USER AGAINST DEFECTS IN WORKMANSHIP OR MATERIALS UNDER NORMAL USE (RENTAL USE EXCLUDED) FOR FIVE YEARS AFTER PURCHASE DATE. ANY PUMP WHICH IS DETERMINED TO BE DEFECTIVE IN MATERIAL AND WORKMANSHIP AND RETURNED TO ALL-FLO, SHIPPING COSTS PREPAID, WILL BE REPAIRED OR REPLACED AT ALL-FLO'S OPTION. CUSTOMER SHALL NOTIFY ALL-FLO IN WRITING WITHIN 30 DAYS OF ANY CLAIMED DEFECTS. NO MATERIALS CAN BE RETURNED WITHOUT THE PRIOR CONSENT OF ALL-FLO, AND IF APPROVED SHALL BE RETURNED TO ALL-FLO FREIGHT PREPAID. ALL-FLO'S LIABILITY FOR ANY BREACH OF THIS WARRANTY SHALL BE LIMITED TO EITHER REPLACEMENT OF THE MATERIALS OR, AT ALL-FLO'S SOLE OPTION, THE REFUND OF THE PURCHASE PRICE. ALL-FLO SHALL NOT BE HELD LIABLE FOR ANY INCIDENTAL OR CONSEQUENTIAL DAMAGES CAUSED BY BREACH OF THIS WARRANTY. THIS EXCLUSION APPLIES WHETHER SUCH DAMAGES WERE SOUGHT BASED ON BREACH OF WARRANTY, BREACH OF CONTRACT, NEGLIGENCE, STRICT LIABILITY IN TORT, OR ANY OTHER LEGAL THEORY. FURTHER, ALL-FLO SHALL NOT BE LIABLE FOR LOSSES, DELAYS, LABOR COSTS, OR ANY OTHER COST OR EXPENSE DIRECTLY OR INDIRECTLY ARISING FROM THE USE OF MATERIALS. ALL-FLO'S LIABILITY IS EXPRESSLY LIMITED TO THE REPLACEMENT OR REPAIR OF DEFECTIVE GOODS, OR THE TOTAL VALUE OF SUCH GOODS. THIS WARRANTY IS IN LIEU OF ALL OTHER WARRANTIES, WHETHER EXPRESS, IMPLIED, OR ORAL INCLUDING THE IMPLIED WARRANTY OF MERCHANTABILITY, ANY IMPLIED WARRANTY OF FITNESS FOR A PARTICULAR PURPOSE, AND ANY IMPLIED WARRANTIES OTHERWISE ARISING FROM A COURSE OF DEALING OR TRADE.

All-Flo will not, in ANY event, be liable for any loss of profit, interruption of business or any other special, consequential or incidental damages suffered or sustained by Customer. All-Flo's total maximum liability to the customer in respect of sale of materials or services rendered by All-Flo is limited to the total monies received by All-Flo from the customer for the particular materials described in Customer's order.

All-Flo does not warrant any part or component that it does not manufacture, but will assign to the original end-user purchaser of any warranty received by it from the manufacturer, to extent such pass through is permitted by the manufacturer.



REGISTRATION FORM

Pump Model _____ Pump Serial Number _____

Company Name _____

Name _____ Email _____

Phone # _____ City _____ State _____ Zip _____

Qty of Pumps _____ Fluid Pumping _____

How did you hear about us?
Existing All-Flo user, Web, Distributor, Magazin ...



Scan the QR code and complete the form on your cell phone or go to :

www.all-flo.com/registration-form.html

E-mail : All-Flo Pump Co.



IMPORTANT ADVICE

1. Some solvents during the boiling phase create such a quantity of foam that a correct separation of the solvent from the polluting product is not possible; in fact, in this case, the distillate will still be dirty. To avoid this inconvenience, it will be necessary to obtain an anti-foam kit supplied as an option.

ANTI-FOAM KIT FOR : MODEL SR30 (#324022) & SR60 (#324026)

2. Pay the utmost attention while the residue is drying; some polluting products with an increase of temperature tend to carbonize with a considerable discharge of smoke from the apparatus.

IN CASE THIS OCCURS, IMMEDIATELY PRESS THE START / STOP KEY TO STOP THE CYCLE.

In this case it is not possible to proceed to drying at atmospheric pressure; the problem may be solved by proceeding to the distillation phase at atmospheric pressure and to the phase of drying under vacuum; this technique will allow you to operate at a much lower temperature.

3. Opening the cover one hour before the distillation cycle is complete will cause the gasket to swell.

4. **Do not** rotate and shake the unit once loaded or when operating.

5. The cover acts as a safety valve. In case vapors come out of the cover stop the unit **IMMEDIATELY** and consult the table on page 24 to 26, « **Troubleshooting** ».

DO NOT MISHANDLE THE COVER LOCKING SYSTEM OR LOCK THE COVER IN ORDER TO AVOID LEAKING.

6. Clean the oil expansion reservoir only with a « wet » rag to avoid generating sparks.



INFORMATION / TECHNICAL ASSISTANCE

ISTpure is a registered trademark of:

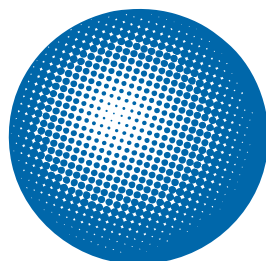

International
Surface
Technologies
istsurface.com

For more information, pricing or technical support, contact your local
IST distributor or call / fax to our Consumer Information numbers:

TEL.: 1 877 629-8202 & 450 963-4400 FAX : 450 963-5122

Or visit us at:
istsurface.com



ABOUT THE COMPANY

WHO WE ARE

IST is a leading industrial manufacturer of standard and custom engineered equipment for the surface treatment industry and the solvent recycling industry.

MISSION

IST is dedicated to being an innovative and trusted supplier in the conception, fabrication and distribution of surface treatment equipment and recycling equipment.

The success of our mission relies on the following core values :

Innovation – Integrity – Quality

MARKETS SERVED

The products, technologies and industry expertise of IST are used in a wide range of manufacturing and industrial applications, including but not limited to :

- General Manufacturing
- Industrial Equipment
- Metal forming
- Aerospace and Aviation
- Rail and Transit
- Marine
- Automotive
- Petroleum
- Flexography (labelling) & Lithography
- Wood finishing
- Power & Energy
- Pharmaceutical

