



SANDBLASTING CABINET - ECAB SUCTION SERIES 120 V



- Warranty
- Safety
- Operation
- Service Parts
- Accessory Information
- Registration Form



INSTRUCTION MANUAL

2022-11-15



TABLE OF CONTENTS

	Page
CABINETS SPECIFICATIONS.....	3
NOTICE TO PURCHASERS AND USERS OF OUR PRODUCTS AND THIS INFORMATIONAL MATERIAL.....	4
SAFETY AND WARNING.....	4
DANGER AND WARNING LABELS	5
GENERAL SAFETY RULES	6
INSTALLATION.....	7
PNEUMATIC CONNECTION.....	7
ELECTRICAL CONNECTIONS.....	8
ABRASIVE MEDIA LOADING.....	9
OPERATION	10
SHUT DOWN - CHANGING THE MEDIA	11
RECLAIMER.....	12
MAINTENANCE CABINET AND DUST COLLECTOR.....	13
NOZZLE AND JET MAINTENANCE	14
TROUBLESHOOTING.....	15 TO 18
SCHEMATIC OF UNIT- EXPLODED VIEW & PARTS.....	19
STANDARD G5 BLAST	20
FOOT PEDAL WITH PILOT VALVE - OPTIONAL SH5 BLAST GUN	21
OPTIONNAL BAGHOUSE DUST COLLECTOR DC50 - GENERAL PARTS LIST	22
OPTIONNAL BAGHOUSE DUST COLLECTOR DC100 - GENERAL PARTS LIST	23
PNEUMATIC DIAGRAM.....	24
ELECTRICAL SCHEMATIC - 1 PH / 240 V - DRAWING	25
ELECTRICAL SCHEMATIC - 1 PH / 240 V - PARTS LIST.....	26
ISTBLAST LIMITED WARRANTY	27
ISTBLAST WARRANTY REGISTRATION.....	28



CABINETS TECHNICAL DATA

GENERAL SPECIFICATIONS	
Cabinet construction	14 gauge
Floor Capacity	500 lb.
Gloves	Nylon 8" diam.
Blasting system	Foot pedal
Piping	1/2" diam.
Nozzle	CN2-5 Ceramic, 5/16" I.D.
Blast Gun	G5
Abrasive Regulator	AR-3/4
Pressure regulator/ gauge	Standard
Glass	14" x 22"
Motor (hp)	1/2
Fan (cfm)	400

MODEL	ECAB 2636S	ECAB 3636S	ECAB 3648S	ECAB 4848S
WORK AREA (D X W X H)	26" x 36" x 32"	36" x 36" x 32"	36" x 48" x 32"	48" x 48" x 32"
OVERALL DIMENSIONS (D X W X H)				
WITH DB13	53" x 42" x 67"	63" x 42" x 67"	63" x 54" x 67"	75" x 54" x 67"
WITH DC50	57" x 60" x 78"	67" x 60" x 78"	67" x 72" x 78"	79" x 72" x 78"
WITH DC100	63" x 62" x 91"	73" x 62" x 91"	73" x 74" x 91"	85" x 74" x 91"
DOOR OPENING (W X H)	20" x 29"	30" x 29"		42" x 29"
WEIGHT (lb)	405	445	467	497



NOTICE TO PURCHASERS AND USERS OF OUR PRODUCTS AND THIS INFORMATIONAL MATERIAL

The products described in this material, and the information relating to those products, is intended for knowledgeable, experienced users of abrasive blasting equipment.

No representation is intended or made as to the suitability of the products described herein for any particular purpose of application. No representations are intended or made as to the efficiency, production rate, or the useful life of the products described herein. Any estimate regarding production rates or production finishes are the responsibility of the user and must be derived solely from the user's experience and expertise, and must not be based on information in this material.

The products described in this material may be combined by the user in a variety of ways for purposes determined solely by the user. No representations are intended or made as to the suitability or engineering balance of the combination of products determined by the user in his selection, nor as to the compliance with regulations or standard practice of such combinations of components or products.

It is the responsibility of the knowledgeable, experienced users of the products mentioned in this material to familiarize themselves with the appropriate laws, regulations and safe practices that apply to these products, equipment that is connected to these products and materials that may be used with these products.

It is the responsibility of the user to insure that proper training of operators has been performed and a safe work environment is provided.

Our company is proud to provide a variety of products to the abrasive blasting industry, and we have confidence that the professionals in our industry will utilize their knowledge and expertise in the safe efficient use of these products.

SAFETY AND WARNING

GENERAL SAFETY

1. Carefully inspect the shipping carton for any signs of transport damage. The damage to the carton often indicates possibility of transport damage to the equipment inside.
2. Carefully remove your IST SANDBLASTING CABINET from the shipping carton and skid.
3. Check your equipment immediately to ensure that it is free of transport damage. Report any transport damage to the carrier without delay for possible claim procedures. International Surface Technologies inc. is not responsible for damage to equipment after it leaves our warehouse.
4. Check the equipment and compare it with the parts you have received. If any parts are missing, contact the supplier you purchased the equipment from.

Before operating the IST SANDBLASTING CABINET, read this Instruction Manual completely. All IST products are engineered and manufactured to the highest performance standards and have been subjected to detail testing before shipment from the factory.



DANGER AND WARNING LABELS

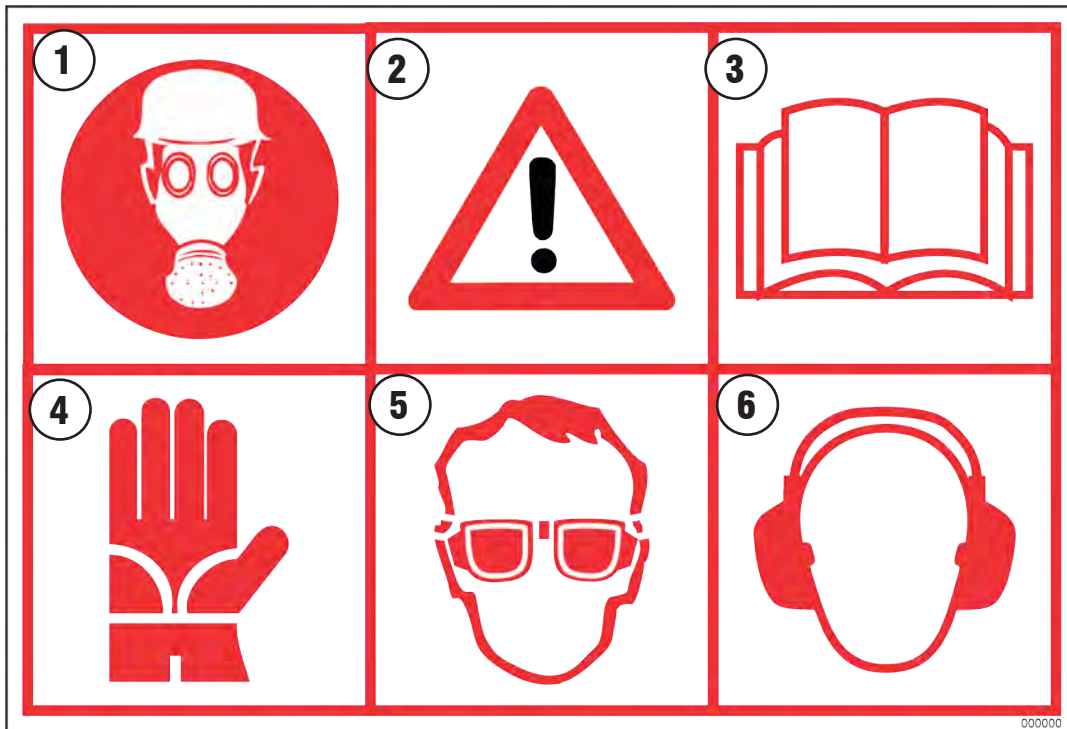

1. Wear breathing mask
2. Observe warnings at all times.
3. Read the Instruction Manual carefully.
4. Wear rubber gloves.
5. Wear protective eyewear before use
6. Wear earing protection before use

WARNING

« READ ALL INSTRUCTIONS » Failure to follow the SAFETY RULES identified by a BULLET (●) symbol listed BELOW and other safety precautions may result in serious personal injury.

« SAVE THESE INSTRUCTIONS »



GENERAL SAFETY RULES

- **KEEP WORKING AREA CLEAN.**
- **KEEP CHILDREN AWAY.** Do not let visitors come in contact with the equipment. All visitors should be kept away from the work area.

PERSONAL SAFETY

WARNING

SANDBLAST CABINET MAY EMIT POTENTIALLY HAZARD DUST AND AIRBORNE CONTAMINANTS DURING OPERATION. YOU MUST WEAR APPROPRIATE BREATHING PROTECTION AT ALL TIMES WHILE OPERATING OR STANDING AROUND THE UNIT.

- **GUARD AGAINST ELECTRIC SHOCK.** Non-skid footwear is recommended where damp or wet ground may be encountered. A ground fault circuit interrupter protected power line must be used for these conditions.
- **DRESS PROPERLY.** Do not wear loose clothing or jewelry. They can be caught in the moving parts. Wear protective hair covering to contain long hair
- **USE SAFETY EQUIPMENT. WEAR SAFETY GOGGLES** or glasses with side shields.
- **WEAR A DUST PROOF MASK. .**
- **STAY ALERT. USE YOUR COMMON SENSE.** Concentrate on what you are doing. Do not operate the unit when you are tired or under the influence of drugs
- **DO NOT OVERREACH THE EQUIPMENT.** Keep proper footing and balance at all times.
- **BEFORE STARTING TO WORK** you must wear earing protections, efficient for 80 dB or more.

UNIT USE AND CARE

- **DO NOT FORCE THE UNIT.** It will perform better and safer at the rate for which it was designed.
- **THE USE OF ANY OTHER ACCESSORIES** not specified in this manual may create a hazard.
- **CLOSE THE MAIN BREAKER SWITCH BEFORE SERVICING** or when not in use.
- **DO NOT ALTER OR MISUSE THE UNIT.** These units are precision built. Any alteration or modification not specified is misuse and may result in a dangerous situation.

Only trained repairmen should attempt (●) **ALL REPAIRS**, electrical or mechanical. Contact the nearest IST ISTblast repair service facility. Use only IST ISTblast replacement parts; any other parts may create a hazard.

ENVIRONMENTAL CONDITIONS FOR WHICH THE EQUIPMENT IS DESIGNED

- Indoor location
- Altitude 6,562 ft max
- Ambient temperature: 104 °F (40 °C) max
- Relative humidity: 80 %
- Main supply voltage fluctuation +/- 10 %
- To use with noncombustible dust only



INTRODUCTION

Welcome to the IST[®] family of sandblasting products. This booklet contains helpful information and acquaints you with the operation and maintenance of your equipment. Please read carefully and follow our recommendations to assure trouble free operation. If you have any questions, please do not hesitate to contact your distributor or our technical service.

INSTALLATION

1. Unbolt the blast cabinet from the pallet. Attach a strap or a hoist to the eyelets located on the top of the machine and move it to its final location using a lift truck or a crane.
2. Make sure the cabinet is leveled and well grounded. Do not place on a wooden floor or a rubber mat, unless a ground wire has been installed. Check with a qualified electrician.
3. Place the system to the installation location
4. Unwrap and remove the cabinet from the pallet
5. Insure there is adequate space on both sides of the cabinet for full opening of part loading/unloading and maintenance access doors.
6. Insure that there is adequate space at both sides of the system for easy access to components such as the reclaimer and dust collector
7. The dust collector should be located on a leveled area near the back of the cabinet, on the right side (while facing cabinet). Attach one end of the corrugated discharge hose to the outlet of the reclaimer and the other end to the inlet located at the bottom of the dust collector. Secure both ends with the supplied clamps. See dust collector section for more details

All IST ECAB Series cabinets are equipped with a dust collector and a 400 cfm fan motor.

PNEUMATIC CONNECTION

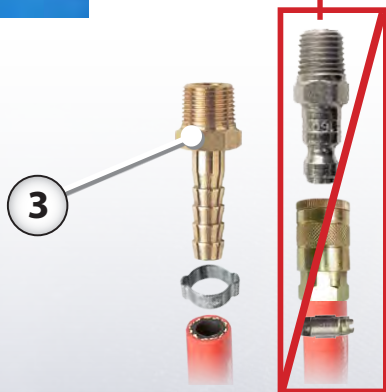

Connect your shop's air supply line to the air inlet. The hose should have a minimum of 1/2 inch inside diameter. Never use male-female quick couplings. **Choose couplings that offer as little restriction to the airflow as possible.**

To properly operate, your IST system use clean, dry air. Moisture or oil from the compressed air supply can contaminate the abrasive, and prevent it from flowing freely and cause inefficient blasting.

CAUTION If you use interlocking connections, secure them with pins. A connection that disconnects under pressure, could cause serious injury.



Air dryer



ELECTRICAL CONNECTIONS

Connect cabinet power supply cord to standard 120 V / 15 A outlet. *Note: None-standard voltage is also available.*

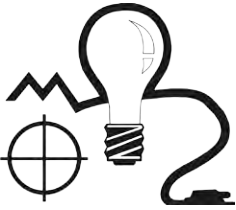

All electrical connections to the IST cabinet should be made by a qualified electrician and must comply to the codes, standards, and procedures specified by the local authority having jurisdiction.

The customer is responsible for providing appropriate disconnecting means adjacent to the equipment for each incoming power circuit.

For detailed electrical connections wiring requirements, overload and starter, Refer to electrical drawings on pages 25 and 26.



It is important to connect the IST system to an Earth Ground to bleed off static electricity, which may be generated while blasting. The Earth Ground may also reduce the discomfort an operator may experience when static electricity is discharged.

VERIFY INSTALLATION

1. Check that all pipe and hose connections are tightly fastened and air tight.
2. Check that all electrical box covers are securely installed.
3. Check that the dust drum under the dust collector is sitting firmly and is center (if equipped).
4. Turn the cabinet snap switch to the "On" position. The cabinet lights will power on and the dust collector fan and the reclaimer will start.
5. Set the blast air pressure regulator to the desired pressure
6. Insert both hands into the cabinet gloves, take the gun and press the foot pedal. Blasting will start, wait a few second and the blast flow will stabilize.
7. Turn the cabinet snap switch to the "Off" position. Light will turn off and the dust collector fan and reclaimer will stop.

CAUTION : Disable and lock out power sources before performing service or maintenance work. Do not look into the fan outlet to determine the correct motor rotation. Check that the fan exhaust is clear of tools and free of debris before checking fan rotation. To avoid personal injury, stay clear of the fan exhaust.

PROPER AIRJET/NOZZLE COMBINATIONS

Make sure you have a proper air jet/nozzle combination. Standard IST suction cabinets are equipped with 5/32" air jets and 5/16" nozzles.

A simple way to determine if you have an incorrect combination is to check the abrasive regulator at the bottom of the reclaimer when the operator's pedal is depressed. If media is being discharged out of the regulator, there is an incorrect jet/nozzle combination or an obstruction inside the gun.

AIR CONSUMPTION TABLE (cfm⁰)

Orifice	Nozzle	PRESSURE (psi ¹)					
		40	50	60	70	80	100 ²
1/8"	1/4"	12	15	17	19	21	26
5/32"	5/16"	19	23	27	30	34	42
3/16"	3/8"	27	33	38	43	48	58
7/32"	7/16"	38	46	52	60	65	80
1/4"	1/2"	49	58	67	76	85	94

⁰ cfm: cubic feet per minute.

¹ psi: Pressure at nozzle in pound per square inch.

² Optimal pressure.



LOADING ABRASIVE MEDIA

WARNING

Your suction cabinet is designed to operate efficiently with most **recyclable abrasive media** on the market. However, certain types such as sand, recycled glass or silica are not recommended and should not be used in our blast cabinet.

These abrasives generate very fine dust that may block the bag's pores, obstruct the ventilation system and cause dust accumulation inside the cabinet while in use. Instead, use reclaimable abrasives such as glass beads, aluminum oxide steel grit or plastic media.

For better results for the reclaiming process, **please call one of our technical representatives** if you have to use a different **type of abrasive** from the one your equipment has been set for at the factory.

Manufactured Abrasives

NAME	TYPE	SHAPE	HARDNESS SCALE	DENSITY PDS/CUFT	CONTENT SILICA	DUST FACTOR	MESH SIZE	REUSE FACTOR	AVAILABILITY
Aluminium Oxide	Oxide	Irregular	8 Mohs	120	None	Low	6-600	Good	Good
Silicon Carbide	Carbide	Angular	9 Mohs	100-110	None	Low	6-600	Good	Good
Glass Beads	Silica	Spherical	5-6 Mohs	100	0 free Silica	Low	20-325	Good	Good
Plastic Grit	Polyurethane	Angular	3-4 Mohs	58-60	None	Low	12-80	Good	Good
Chilled Iron & Steel Grit	Metallic	Angular	40-68 Rc Rockwell C	250	None	Very Low	18-200	High	Good
Chilled Iron & Steel Shot	Metallic	Spherical	40-68 Rc Rockwell C	250	None	Very Low	7-200	High	Good

LOADING ABRASIVE MEDIA

Follow these steps to avoid locking the drain at the bottom of the cabinet when adding a brasive media.



1. Turn on the cabinet to activate the vacuum system.



2. **SLOWLY** add **approximately** half a bag of abrasive media through the grating inside the cabinet.



NOTE: Some cabinets can hold more than half a bag when added gradually.



OPERATION

Turn on compressed air and turn on lightning and motor with the power switch. Compressed air must be clean, dry, and oil free.



1. When using the unit, air pressure (**should not exceed 110 psi**) Place the part to be treated inside the cabinet. The parts must be free of oil, grease, and moisture. Close and latch the cabinet load doors.
2. After closing the door, insert your hands into the two front glove openings. The blasting gun should be held firmly in one hand and the part to be treated in the other hand. The stream of abrasive should be oriented to the bottom of the working area.
3. Depressing blast control pedal will release compressed air flow to the blast gun. As the compressed air passes through the air jet, it creates a vacuum inside the gun and sucks up the media from the reclaimer and propels it out through the nozzle. Hold the gun or nozzle at a 90° angle to the part at a distance that produces the fastest results. The reclaimer screen will require periodic cleaning. The frequency of cleaning will depend on the volume of debris produced. See maintenance section at page 14 for more information.
4. After the media has blasted the part, the reclaiming system vacuums up the abrasive, dust and foreign material through the conduit at the bottom of the cabinet to the reclaimer. The reusable abrasive is separated from the dust and foreign material and is returned to the storage hopper for reuse. The dust bag or the cartridges of the dust collector, filters the dust and fine particles. Larger pieces of contaminants are trapped in the hopper's screen drawer.

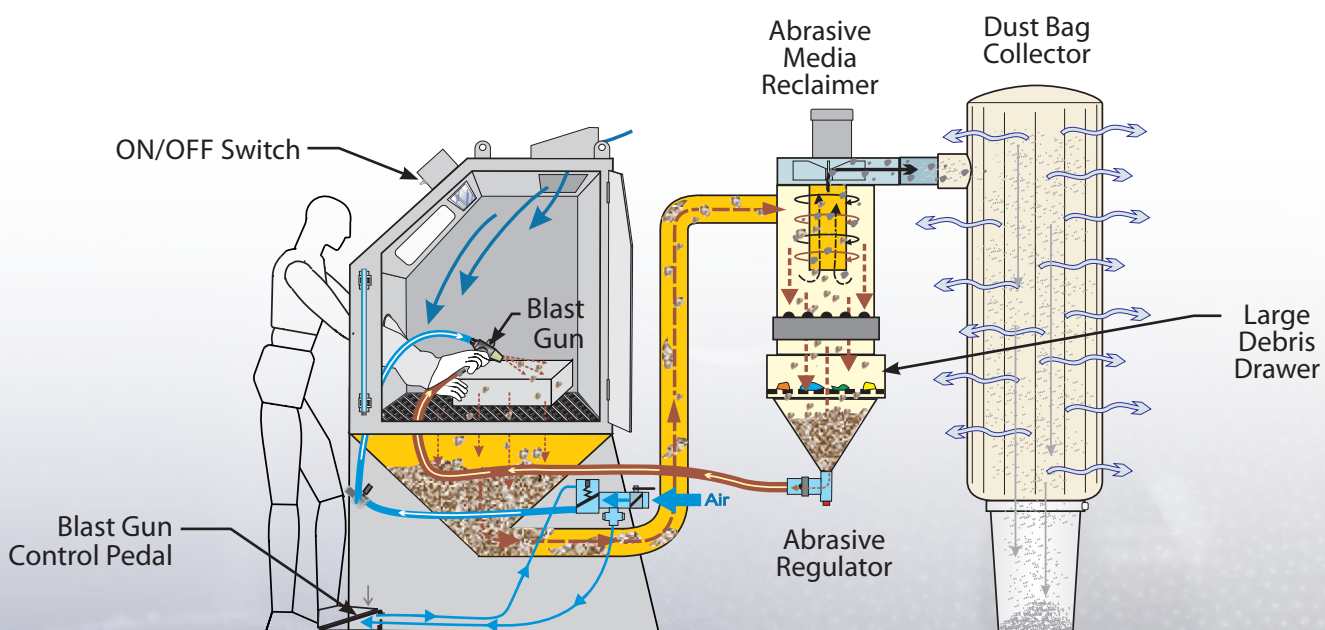



SHUT DOWN

1. Release the foot treadle. The blast will stop.
2. Once cleaning is finished, await 10 to 15 seconds before turning off the power switch and opening the door of the cabinet in order to allow the evacuation of dust in suspension.
3. Open the door and remove the treated parts from the blast cabinet.
4. Close air supply.
5. Turn power switch to the "OFF" position.
6. Empty the dust collector waste drum (Optional part). Replace the drum squarely on the dust drum platform and centered under the cover. The dust drum and cover must create an airtight seal.
7. Shake bags of your dust collector (disregard if you system is equipped with optional automatic bag shaker).

CHANGING THE MEDIA

When changing from one type or size of media to another, it can be extremely important to clean out the blast and recovery hoses, storage hopper, and the cabinet interior thoroughly to avoid contamination of the new media.

During normal sandblasting operation, the media should be replaced completely every 8 hours.

CLEANING THE SYSTEM

1. Turn the system off.
2. You need a container large enough to collect used media. Place the container under the AR $\frac{3}{4}$ valve (part 12, page 19).
3. Remove AR $\frac{3}{4}$ rubber plug (part 13, page 19), media will fall in your container.
4. Place the container under the corrugated dust conduct hose connecting the cabinet with the media reclaimer at the outlet connection of the cabinet.
5. Remove the corrugated dust conduct hose from the cabinet outlet and force the media to fall into the container. Remove the cabinet floor for better access to the bottom of the cabinet. Turn on system and press foot pedal, to make sure all media as been removed from the blast hose and nozzle.
6. Turn on system and press foot pedal, to make sure all media as been removed from the blast hose and nozzle.
7. Turn off system and put back AR $\frac{3}{4}$ rubber plug (part 13, page 19).
8. When cleaning is done put back everything in place.

RELOADING WITH NEW ABRASIVE MEDIA

Refer to Abrasive Loading procedure on page 9.



RECLAIMER

Although the reclaimer is factory set, it is possible to increase the amount of fine dust to be sucked up by the dust bag or dust collector. Just move the rubber band to adjust the obstruction of the holes located behind it. There are **two methods to change those settings**.

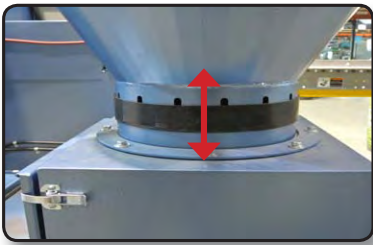

1. Adjustment of the SBR 1/8" x 2" rubber band

This adjustment will influence the quantity of dust that will be evacuated to the dust collector. Proceed step by step, moving the rubber band 1/4" at the time, covering or uncovering the slots behind it. **A wider opening will draw up more dust to the dust collector; a smaller opening will reduce that quantity. The equipment has to run for approx. two (2) hours** before any changes can be noticed. Repeat as needed.

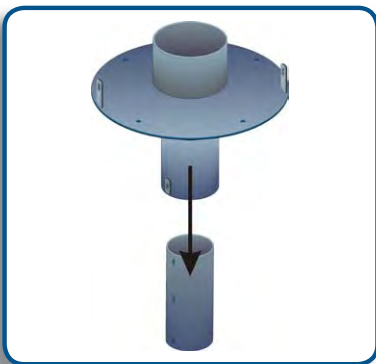

2. Adjustment of the telescopic tube, inside of reclaimer

If, after a few tests, the rubber band adjustments should prove to be insufficient, you will have to proceed to the telescopic tube adjustment. This will be necessary if you have to change the abrasive type or granulometry. Proceed step by step, moving the tube up or down, 1 inch at the time. The equipment has to run for approx. two (2) hours before any changes can be noticed. Repeat as needed. Moving the tube downward will increase the quantity of dust drawn up by the dust collector, moving it up will decrease that quantity.

AR 3/4 ABRASIVE REGULATOR



Located at the bottom of the reclaimer, the AR 3/4 abrasive regulator meters the amount of media discharged from the nozzle. Be sure that nothing seals off the hole completely. You can adjust the opening using the adjustable clamp that must be located over it, covering about 2/3 of the hole. A smaller opening will bring more abrasive to the nozzle; a wider opening will bring less abrasive. A complete opening or a complete covering will interrupt the abrasive flow. To insure the performances of your equipment, the compressed air supply must be clean and dry. Oil or humidity in the compressed air will cause an abrasive jam at the abrasive regulator level, reducing and even stopping the abrasive flow.

MAINTENANCE CABINET AND DUST COLLECTOR

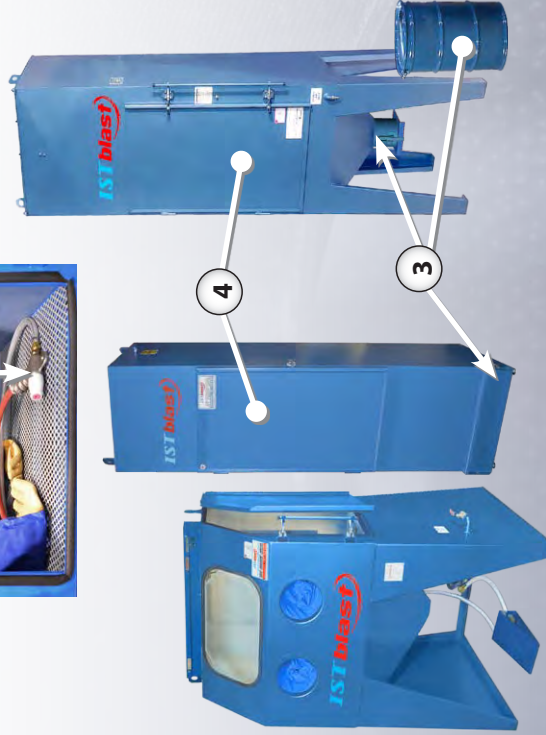
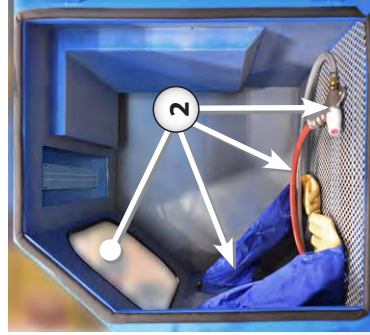
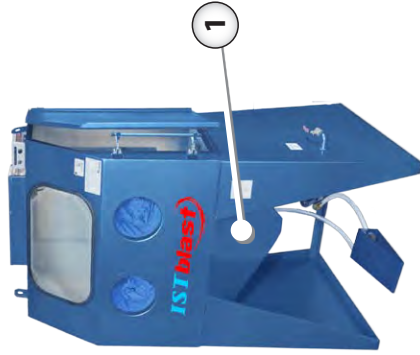

DAILY MAINTENANCE & OPERATION

1. Check both the quantity and quality of abrasive frequently. If required, clean out the system and reload with new media.
2. Check for wear on all parts in direct contact with the blasting action: nozzle, gloves, window, plastic shield, air-jet, gun etc. Special attention must be given to nozzle, nozzle ring and rubber protector to avoid premature wear of gun. Make sure ventilation inlet is always free of obstruction.
3. Empty dust drawer (DC50) or dust barrel (DC100) or dust collector's bottom hopper regularly.
4. After each use, shake bags inside the dust collector. Never shake bags while the cabinet is running. Never wash bags, instead use compressed use compressed air, **blowing from the outside to the inside of the bag**, (the opposite would clog the bag's pores and make it unusable).

WEEKLY

- **Sandblast Nozzle:** check the I.D. using a drill bit that is 1/8" wider than the original diameter of the nozzle. If the drill bit fits in, replace the nozzle. A worn nozzle will cause a drop of abrasive pull and velocity.
- **Abrasive Hose:** check abrasive hose for wear. It has to be changed before it gets any perforation. Give a special attention to parts of the hose that are curved.
- **Couplings and Gaskets:** check on a regular basis the hose couplings and gaskets for wear.
- **Media filters:** replace bags when the dust collector is unable to evacuate the dust cloud from the cabinet.



NOZZLE AND JET MAINTENANCE

Nozzle: check the nozzle regularly for wear using a drill bit
1/8" larger than the original nozzle diameter

IT GOES THROUGH

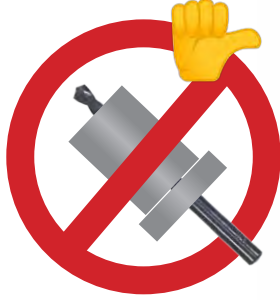

WORN NOZZLE
TO BE REPLACED

DOES NOT GOES THROUGH



NOZZLE IN GOOD SHAPE

The diameter of the orifice should never exceed 1/8" of wear

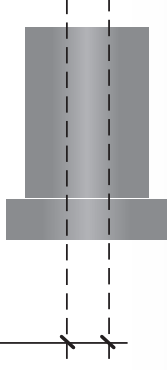

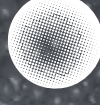
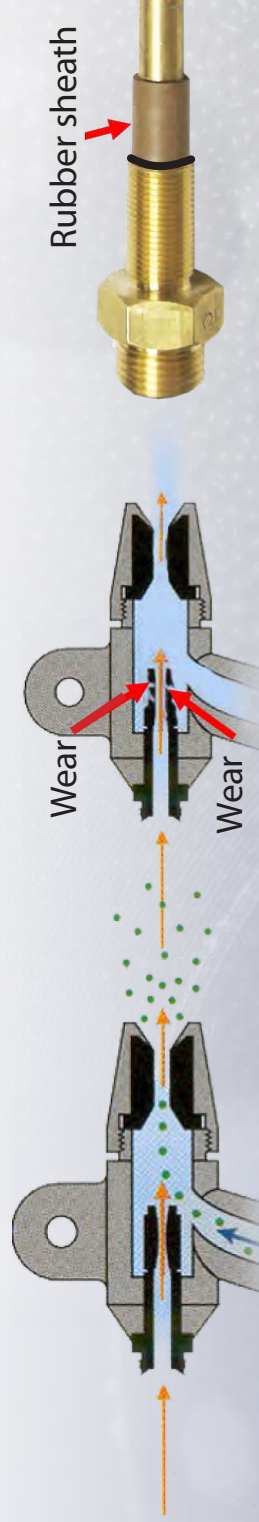

Air Jet : check regularly the wear of the injector and replace the rubber sheath if necessary to avoid wear from the outside





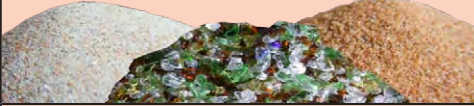
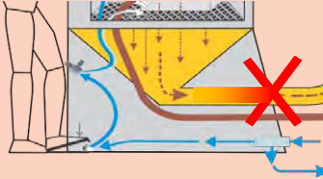
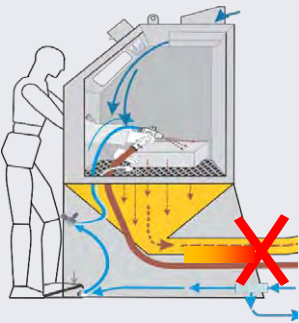

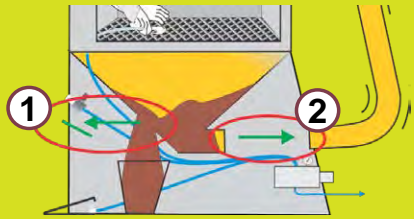
TROUBLESHOOTING

TYPE OF FAILURE	POSSIBLE CAUSE	SOLUTION
<p>Excessive dust in the cabinet (poor visibility) and / or very dusty abrasive (inefficient)</p>	<p>Non-recyclable abrasive³</p> 	<p>Follow abrasive drain and cleaning procedures and replace with recyclable abrasive.</p>
	<p>Suction hose (behind the cabinet) is partially or completely blocked</p> 	<p>Follow the procedures for resolving a clogged suction hose.</p>
<p>Suction hose outlet (behind the cabinet) partially or completely blocked</p> 	<p><u>Incorrect filling procedure:</u> too much abrasive or poured too quickly.</p> 	<p>Open the service door (1) and disconnect the abrasive suction hose (2) at the bottom of the hopper, remove the abrasive in excess and repeat the filling procedures properly.</p> 
	<p>Lack of cfm (problem with the dust collector) which causes the outlet to become progressively blocked.</p>	<p>Follow the procedures for resolving a dusty cabinet as described above.</p>

³ Never use non-recyclable abrasive in IST cabinets, such as slag, silica sand, recycled glass, or other like them. IST cabinets are designed to be used exclusively with recyclable abrasive that generates a limited amount of dust. Ask your IST representative for more information.

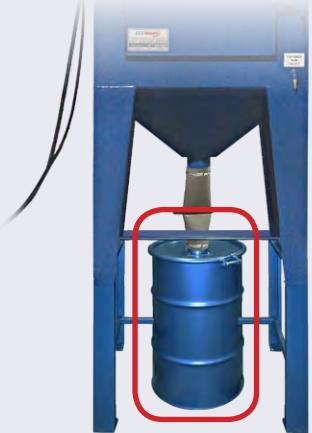

TROUBLESHOOTING (CONT'D)

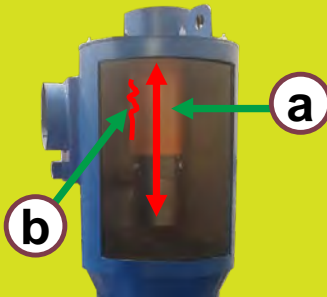
TYPE OF FAILURE	POSSIBLE CAUSE	SOLUTION
<p>"Good" abrasive ends up in the dust container of the dust collector</p> <p>Too much velocity (cfm) in the cyclone separator</p> 	<p>Incorrect adjustment of the rubber band of the cyclonic separator</p>	 <p>Cover gradually the holes with the rubber band to reduce the velocity flowing through the cyclonic separator</p>
	<p>The seal around the debris drawer is damaged or not properly installed</p>	 <p>Check the gasket around the drawer to make sure it is tight and replace if necessary.</p>
	<p>a. The central tube of the cyclonic separator is not adjusted properly due to a change of abrasive</p>	 <p style="text-align: center;">Contact your IST representative</p>
	<p>b. The central tube of the cyclonic separator is perforated at the inlet of the separator</p>	

⁴The center tube of the cyclonic separator is factory adjusted for the abrasive specified at the time of purchase. If the abrasive changes during operation, it may be necessary to readjust the inner tube to alter the movement and flow of air within the cyclonic separator.

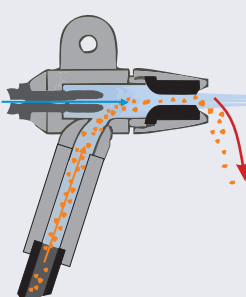
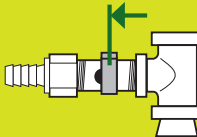
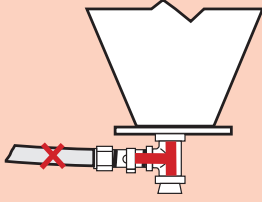
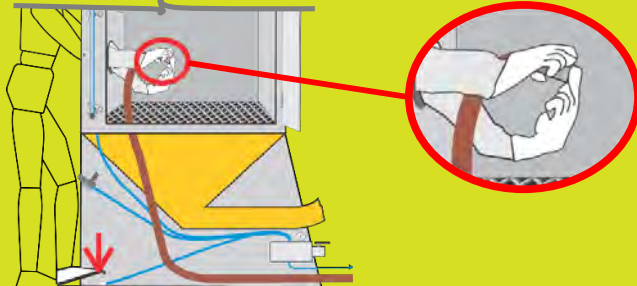
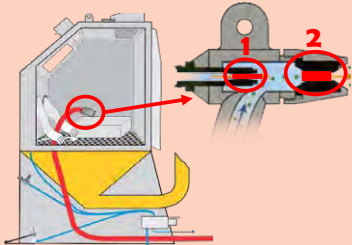

TROUBLESHOOTING (CONT'D)

TYPE OF FAILURE	POSSIBLE CAUSE	SOLUTION
<p>Lack of abrasive in the mix (the nozzle blows mainly air)</p> 	<p>Incorrect adjustment of the AR ¾ Abrasive Valve</p> 	<p>Slightly close the opening of the AR ¾ valve and test again : Less air = more abrasive</p>
	<p>Blocked AR¾ abrasive valve and/or abrasive transport hose to nozzle</p> 	<ol style="list-style-type: none"> Place a finger at the nozzle opening to obstruct the air outlet and activate the blaster to force air upstream of the nozzle to unblock it. 
	<p>Abrasive transport hose to nozzle is obstructed (gun) or improperly installed. Wrong air jet to nozzle opening ratio.</p> <p>The ratio should be 2 to 1 (nozzle inner diameter = 2 times air jet inner diameter)</p>	<ol style="list-style-type: none"> Inspect the hose for holes (especially under the screened floor if it has been exposed to abrasive blasting) and replace as necessary. Remove the gun from the hose and insert it again to the bottom of the hose.
		<p>Disassemble the gun and check the nozzle and the air jet for wear:</p> <ol style="list-style-type: none"> If the nozzle is damaged by excessive wear from the outside, replace it. If the internal diameter of the nozzle exceeds 1/16" of its original size, replace it.

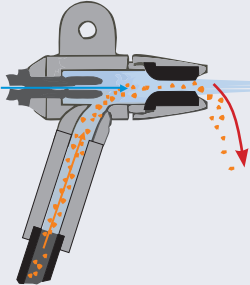
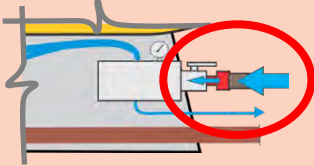
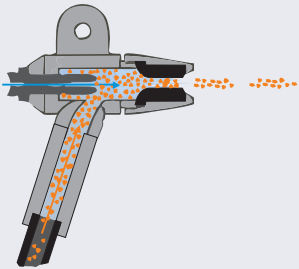
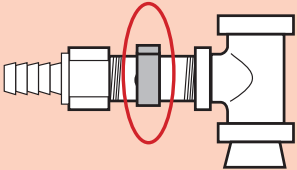
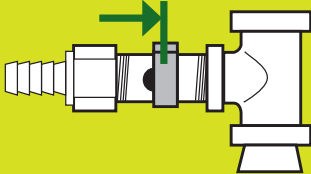

TROUBLESHOOTING (END)

TYPE OF FAILURE	POSSIBLE CAUSE	SOLUTION																																																
<p>Lack of abrasive in the mix (the nozzle blows mainly air)</p> 	<p>Air supply problem (using a quick connect or a connection that creates a restriction to the cabinet air supply)</p> 	<p>Follow cabinet air connection guidelines (see chart page 8)</p> <table border="1" style="margin: 10px auto;"> <thead> <tr> <th rowspan="2">Buse ID</th> <th colspan="6">Pression (psi)</th> </tr> <tr> <th>40</th> <th>50</th> <th>60</th> <th>70</th> <th>80</th> <th>100</th> </tr> </thead> <tbody> <tr> <td>1/4"</td> <td>12</td> <td>15</td> <td>17</td> <td>19</td> <td>21</td> <td>26</td> </tr> <tr> <td>5/16"</td> <td>19</td> <td>23</td> <td>27</td> <td>30</td> <td>34</td> <td>42</td> </tr> <tr> <td>3/8"</td> <td>27</td> <td>33</td> <td>38</td> <td>43</td> <td>48</td> <td>58</td> </tr> <tr> <td>7/16"</td> <td>38</td> <td>46</td> <td>52</td> <td>60</td> <td>65</td> <td>80</td> </tr> <tr> <td>1/2"</td> <td>49</td> <td>58</td> <td>67</td> <td>76</td> <td>85</td> <td>94</td> </tr> </tbody> </table> <p>And use only straight couplings as indicated in the manual</p>	Buse ID	Pression (psi)						40	50	60	70	80	100	1/4"	12	15	17	19	21	26	5/16"	19	23	27	30	34	42	3/8"	27	33	38	43	48	58	7/16"	38	46	52	60	65	80	1/2"	49	58	67	76	85	94
Buse ID	Pression (psi)																																																	
	40	50	60	70	80	100																																												
1/4"	12	15	17	19	21	26																																												
5/16"	19	23	27	30	34	42																																												
3/8"	27	33	38	43	48	58																																												
7/16"	38	46	52	60	65	80																																												
1/2"	49	58	67	76	85	94																																												
<p>Too much abrasive in the mix (the jet is jerky and discharges too much abrasive)</p> 	<p>Incorrect adjustment of the AR 3/4 abrasive metering valve</p> 	<p>Slightly open the orifice of the AR 3/4 valve : More air = less abrasive</p> 																																																



SCHEMATIC OF UNIT- EXPLODED VIEW & PARTS

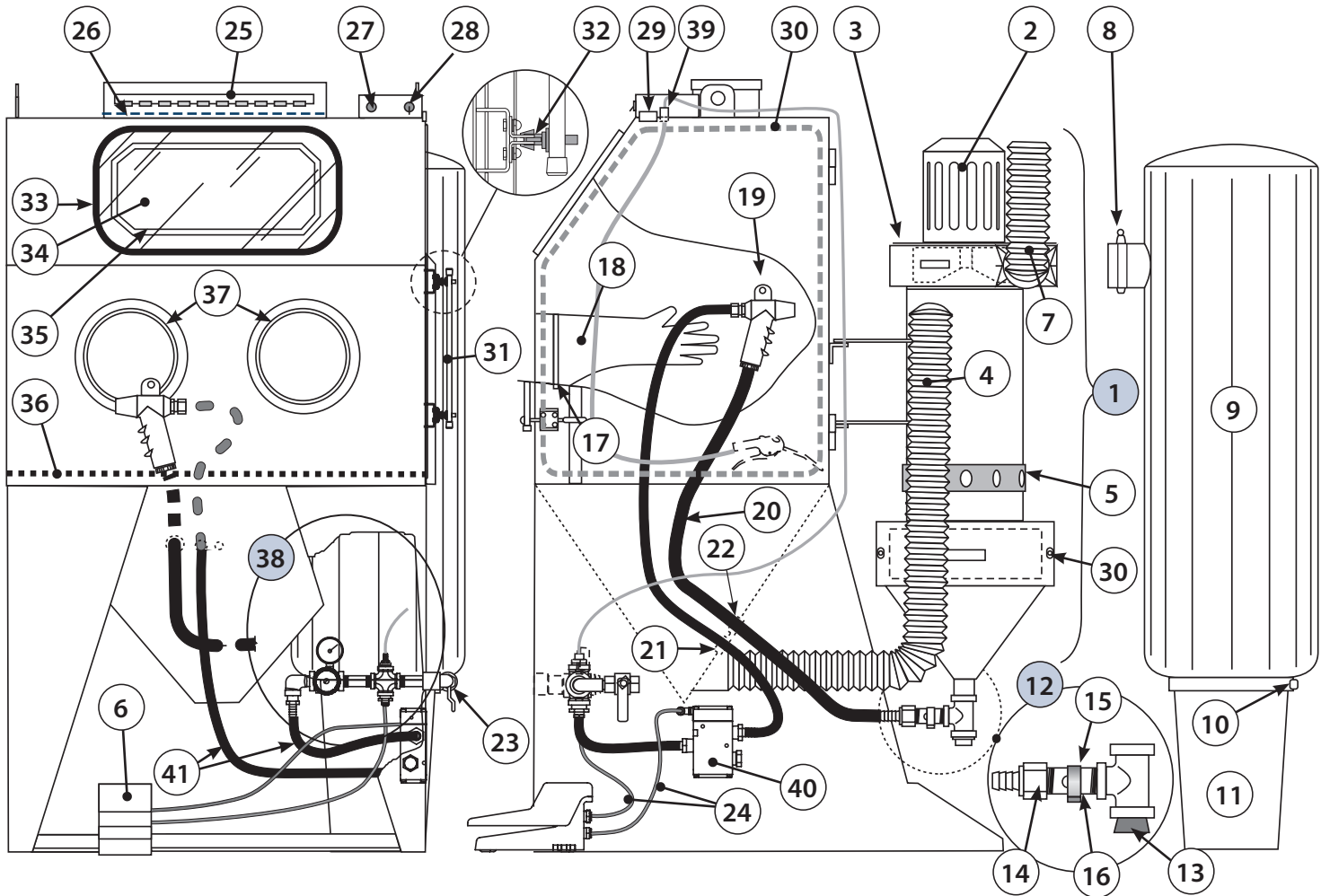

1	609186	RVM 10" Complete Reclaimer with Motor
2	616311	½ hp Electric Motor 120 V / 1ph / 60 Hz / 3450 rpm
3	610525	½ hp Impeller
4	606161	3½ " Suction hose (sold per foot)
5	618334	SBR Rubber ½" x 2" wide
6	*****	Factory Mounted Foot Pedal (see details page 21)
7	606167	4" Dust Collector Suction Hose
8	624117	T Clamp #64 (4")
9	601315	DB-13 Dust Bag
10	624137	T Clamp T-188 (11¼")
11	601310	23 L White Plastic Dust Pail
12	608010	Complete AR-¾" Regulator
13	939143	Threaded Polyethylene Plug for AR-¾" Abrasive Regulator
14	632960	PL Adaptor ¾" FPT x ½" B
15	608011	AR ¾" Clip
16	630505	SP Nipple ¾" X 3"
17	624128	T-Clamp T-128 8" (sold per unit)
18	603212	Nylon Sleeve Gloves, 8" ID x 30" long (sold in pairs only)
19	*****	G5 Foot Operated Sandblast Gun (see page)
20	606148	Multi-Purpose Abrasive Hose ½" (sold per foot)
21	618126	Air Hose Grommet ½" (¾")
22	618127	Abrasive Hose Grommet ½" (7/8")
23	608102	½" Female Ball Valve for Compressed Air Inlet

24	324571	¼" Poly blue tubing (sold per foot)
25	617161	24" LED Light Fixture
26	610322	Protective Glass for 24" LED Light Fixture
27	616934	AGC fuse 2 A / 250 V
	616907	Fuse Holder
28	617014	ON/OFF Switch
	617019	Switch Protection
29	600116	Safety Switch Option ECAB 3-5-7
30	618321	¼" X 1" D type Rubber Gasket (Sold Per Foot)
31	610288	ISTBLAST® Standard Door Lock
32	910223	Door Latch Rubber Bumper Screw
33	610207	Window Rubber Gasket
34	610205	14" X 22" Laminated Safety Window
35	613026	RPW 26 Self-Adhesive Protective Acetate
	610455	ECAB2636S - 26" x 36" Expanded Steel Floor
	610458	ECAB3636S - 36" x 36" Expanded Steel Floor
	610459	ECAB3648S - 36" x 48" Expanded Steel Floor
	610463	ECAB4848S - 48" x 48" Expanded Steel Floor
37	630229	8" Ø Glove Flange
38	See p.	Pressure Regulator & Gauge (+ Air Blow Gun - Optional)
39	324503	¼" MTP x ¼" TU Bulkhead Fitting
40	610347	Pilote Valve (see detail p.)
41	606104	½" White PVC Air Hose (sold by foot)



STANDARD G5 BLAST GUN

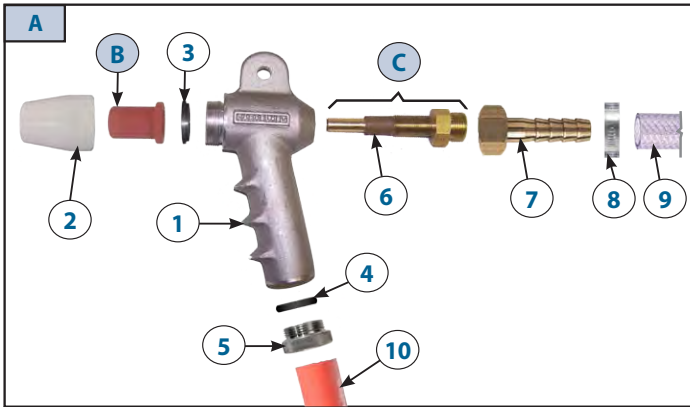

Pre-assembled gun	1	610119	Blast Gun Body only
	2	607037	Nozzle Adaptor
	3	618017	NW-2 Rubber Washer
	4	618112	O-Ring
	5	607038	Hose Adaptor
	6	618219	Rubber Protector
	7	632771	1/2" Brass Female Swivel Hose Barb
	8	624015	3/4" O-Clamp
	9	606104	1/2" PCV Compressed Air Hose (sold per foot)
	10	606148	1/2" Multipurpose Abrasive Conveying Hose (sold per foot)

* Kits A- B-C, see list below

PROPER AIR JET/NOZZLE COMBINATIONS								
Complete blast guns (preassembled*)		Nozzles				Air jet (Complete)	Orifices ±	
G5	Nozzles	Type	Orifice	Length	Code			
A		B				C		
	610121	Ceramic	CN2-4	1/4"	1-1/4"	605004	610116	1/8"
	610120	Ceramic	CN2-5	5/16"		605005	610117	5/32"
	610166	Ceramic	CN2-6	3/8"		605015	610109	3/16"
	610122	Ceramic	CN2-7	7/16"		605006	610118	7/32"
	610123	Tungsten	TN2-4	1/4"		605007	610116	1/8"
	610124	Tungsten	TN2-5	5/16"		605008	610117	5/32"
	610167	Tungsten	TN2-6	3/8"		605018	610109	3/16"
	610125	Tungsten	TN2-7	7/16"		605009	610118	7/32"
	610126	Boron carbide	BN2-4	1/4"		605010	610116	1/8"
	610127	Boron carbide	BN2-5	5/16"		605011	610117	5/32"
	610168	Boron carbide	BN2-6	3/8"		605021	610109	3/16"
	610128	Boron carbide	BN2-7	7/16"		605012	610118	7/32"

NOZZLE PROPERTIES

CERAMIC NOZZLE

CN_



Cost-efficient nozzle for occasional use with soft abrasive media, such as glass beads, walnut shell, and steel shot / grit.

TUNGSTEN CARBIDE NOZZLE

TN_

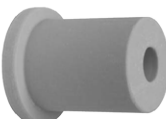

Higher durability nozzle for regular use with highly abrasive media, such as aluminum oxide and GMA Garnet.



FOOT PEDAL WITH PILOT VALVE

Foot Pedal

Pilot Valve

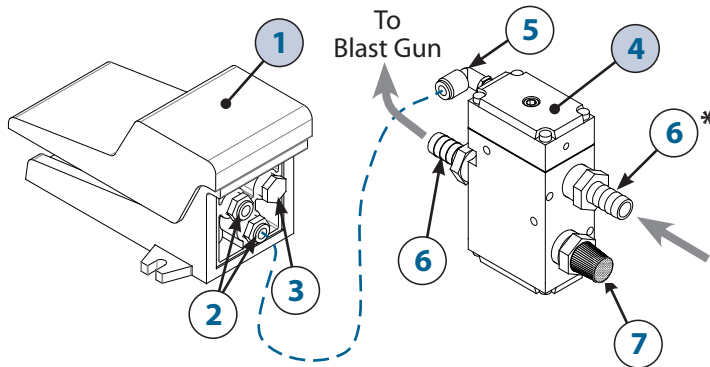

ID	N° Pièce	Description
1	908065	Pneumatic Foot Pedal (complete)
2	950264	1/4" Push-in Fittings
3	632551	1/4" Brass Plug
4	608519	1/2" FPT Air Pilot Valve
5	608519	1/8" MPT - 1/4" Tube Push-in Fitting
6	608519	1/2" MPT Hose Barb Connector
7	608287	1/2" MPT Muffler

MANIFOLD: PRESSURE REGULATOR & GAUGE

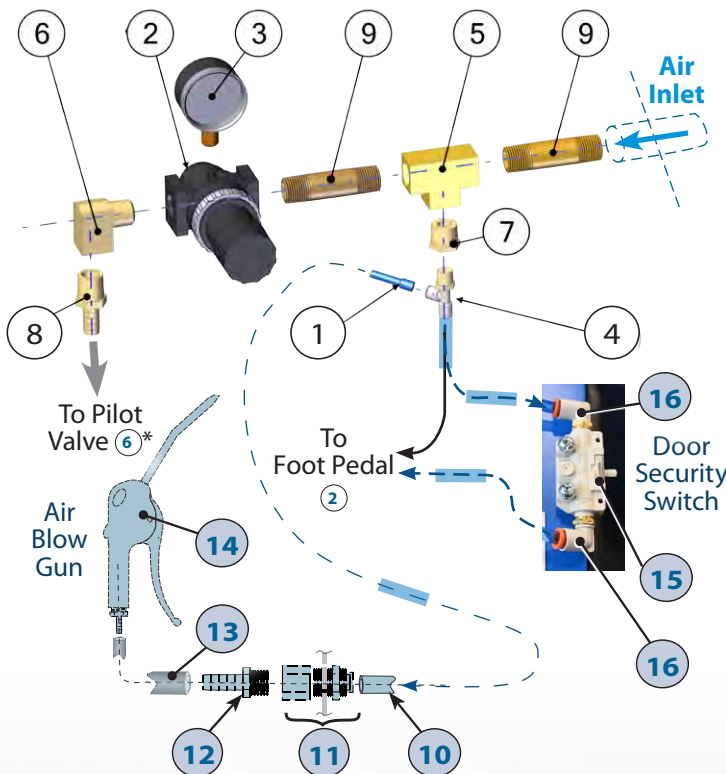

ID	Part #	Description	Qty
1	324504	1/4" Push-in fitting plug (if no Air Blow Gun)	1
2	608022	1/2" Pressure Regulator	1
3	611022	1/4" MPT, 0-160 psi Pressure Gauge	1
4	612453	1/4" FPT Tee Push-in fitting	1
5	632720	1/2" FPT PL Tee	1
6	632730	90° Elbow PL 1/2" MPT x 1/2" FPT	1
7	632745	1/2" MPT @ 1/4" FPT Hex. Reducer	1
8	632760	1/2" MPT x 1/2" Hose Barb	1
9	932108	1/2" x 3" Lg. PL Nipple	2

OPTION: AIR BLOWGUN

10	324571	1/4" Blue Poly. Tube (sold/ft.)	1
11	324503	1/4" MTP x 1/4" TU Bulkhead Fitting	1
12	632270	1/4" MPT x 1/4" TU Hose Barb Fitting	1
13	606147	1/4" Multi. Hose (sold/ft.)	1
14	610275	Complete Air Blow Gun	1

OPTION: DOOR SECURITY SWITCH(ES)

15	600116	Door Security Switch	1 (OR 2)
16	324561	1/8" MPT x 1/4" TU FPT Push-in Fitting	2

OPTION: SH5 BLAST GUN

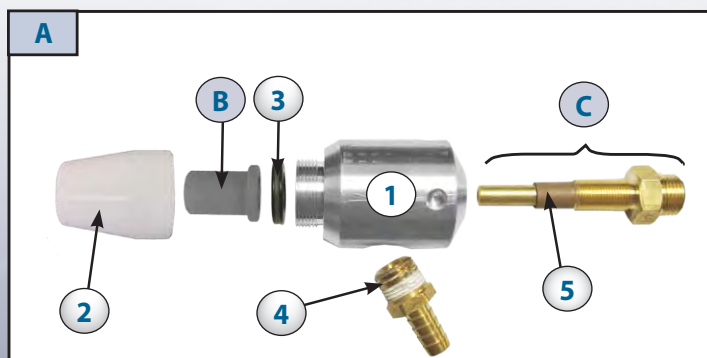

pre-assembled gun	ID	Part #	Description
	1	610134	SH-5 Blast Gun Body Only
	2	607037	NA-G5 / SH5 Nozzle Adaptor
	3	618017	NW-2 Rubber Washer
	4	632760	1/2" Stem Brass Hose Barb
	5	618219	Rubber Protector

A, B, C: see chart page 20

-	600180	Option : ground	By/ft.
---	--------	-----------------	--------



OPTIONAL BAGHOUSE DUST COLLECTOR DC50 - GENERAL PARTS LIST

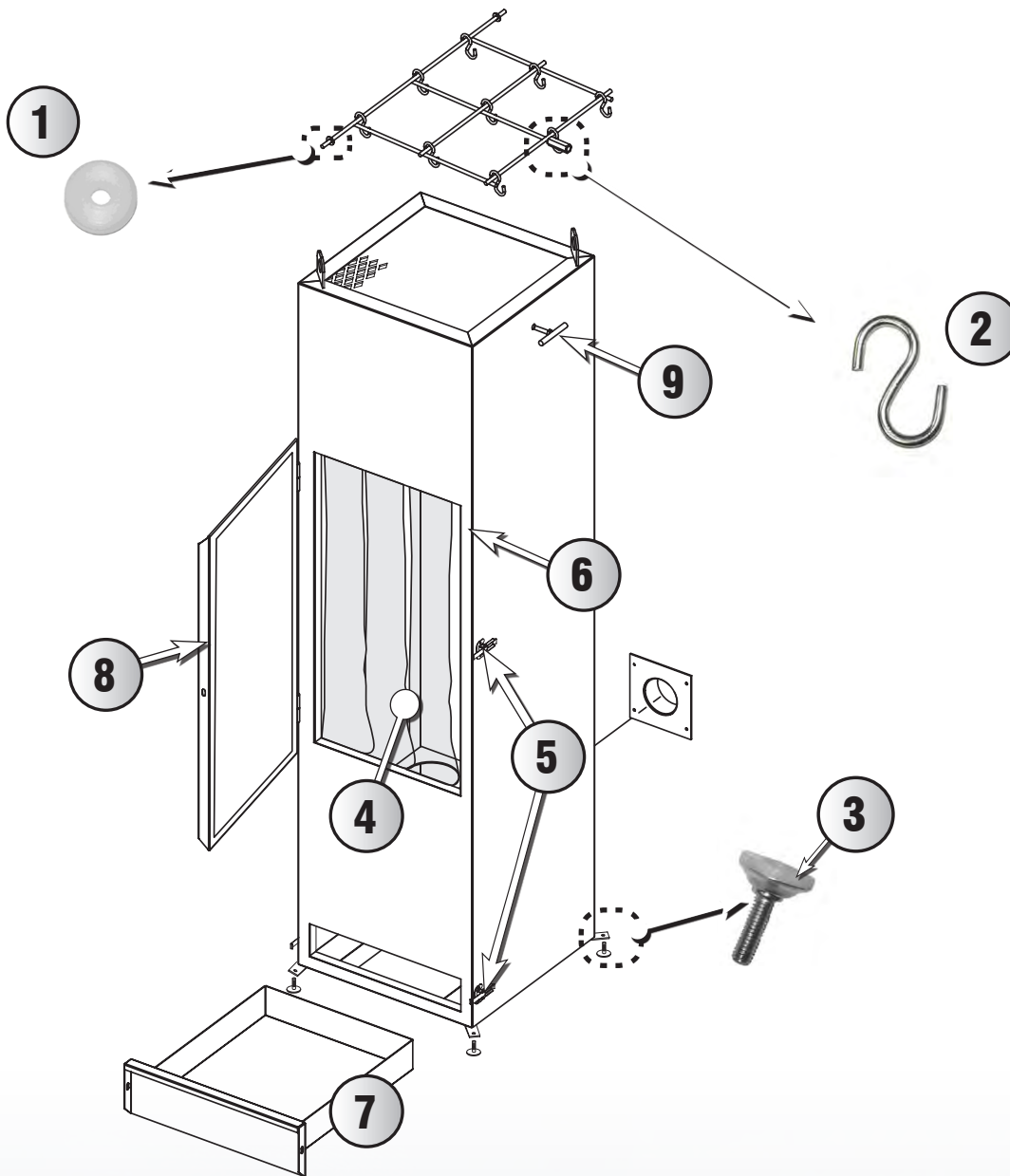

#	STOCK	DESCRIPTION*
1	619006	DC 50 WHEEL
2	601309	"S" HOOK
3	612427	LEVELING LEG
4	601316	DB6HP DUST BAG 56"LG X 5¼" DIAM.
5	610269	DOOR LATCHE

#	STOCK	DESCRIPTION*
6	618321	TYPE "D" RUBBER (SOLD PER FOOT)
7	NPN	DUST DRAWER
8	NPN	ACCES DOOR
9	NPN	HANDLE, MANUAL SHAKER

* (All items are sold per foot or per unit)



OPTIONAL BAGHOUSE DUST COLLECTOR DC100 - GENERAL PARTS LIST

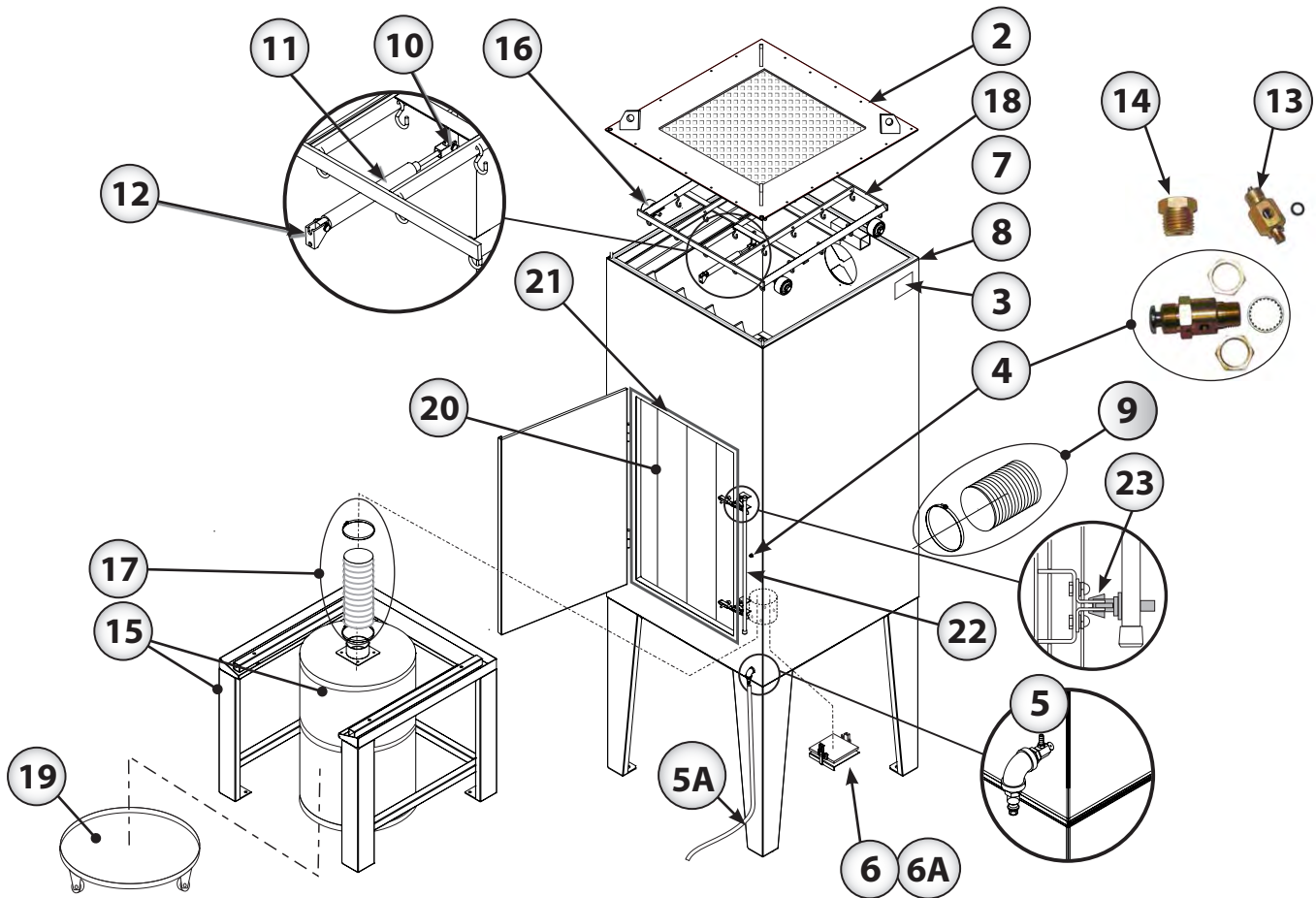

#	STOCK	DESCRIPTION	#	STOCK	DESCRIPTION
1	-/-	Hose & Clips: see parts page 15	10	608406	Clevis rod
2	601340	Top plate	11	608405	3/4" Ø x 3" stroke cylinder
3	NPN	Name plate	12	608407	Bracket for cylinder
4	608508	Pneumatic shaker button	13	608408	Flow adjust 10-32
5	NPN	Air inlet (quick connect 1/4" M # 607222, & 1/4" F # 607219)	14	608409	1/4" adaptor
5A	606112	Urethane hose 1/8"	15	601486	Dust barrel & extens. legs option
6	601371	Dust trap	16	619005	2" wheel
6A	618305	1/2" x 1" self-adhesive rubber foam (sold per foot)	17	609158	4" dust hose (SOLD PER FOOT)
7	610280	8" adjustable air inlet	18	601309	"S" hook
8	618318	1/4" x 1/2" self-adhesive rubber foam	19	501182	Optional trolley for 15 gal barrel
9	606171	7" dust conveying hose (sold per foot)	20	601316	DB 6 hp dust bags (Qty : 16)
9A	624127	7" Hose Clamp (sold per foot)	21	618321	Type "D" rubber (sold per foot)
			22	610287	Complete door handle
			23	610223	Door latch



PNEUMATIC DIAGRAM

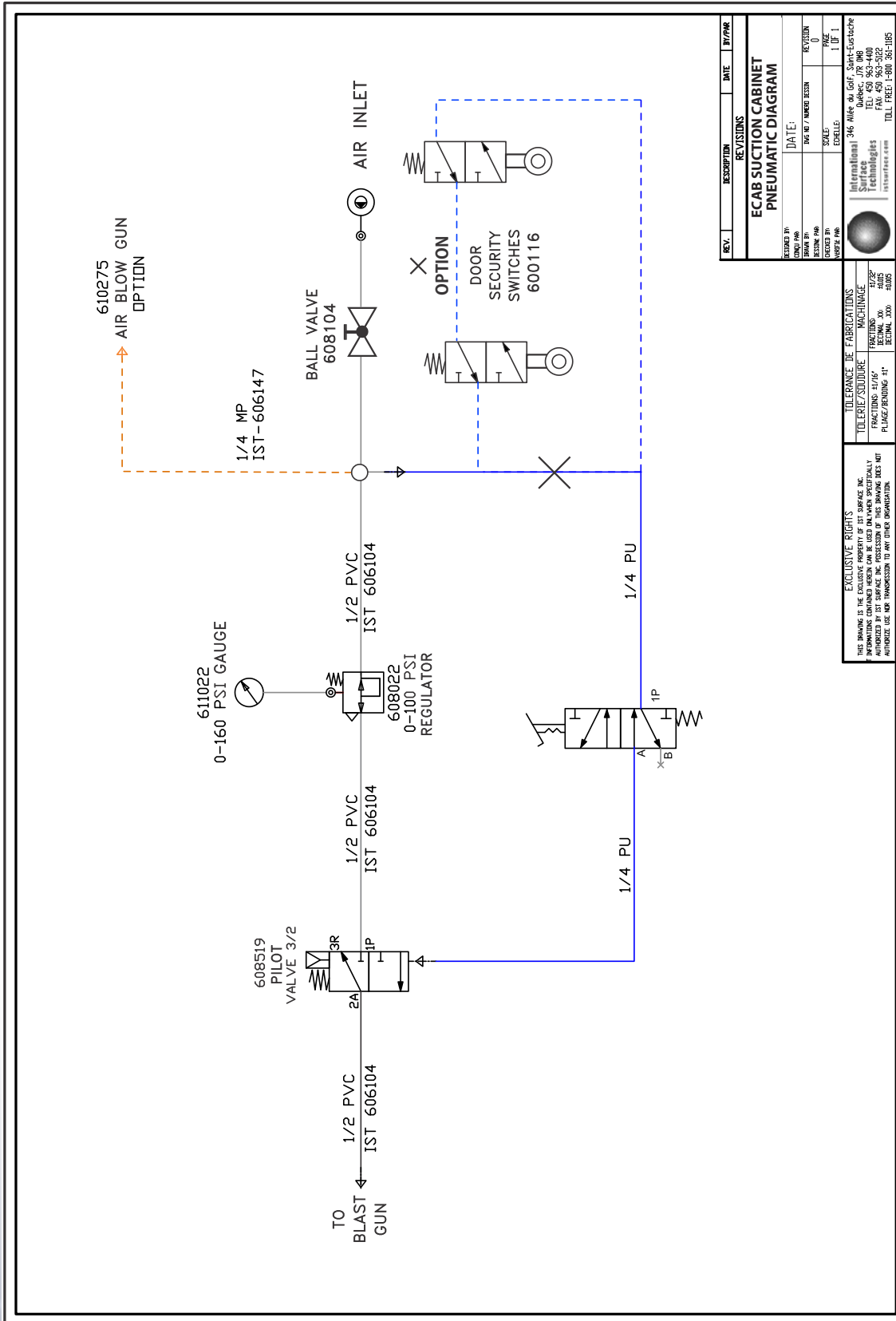

REV.	DESCRIPTION	DATE	BY/APP
REVISIONS			
ECAB SUCTION CABINET PNEUMATIC DIAGRAM			
DESIGNED BY:	DATE:	REVISED:	
DRAWN BY:		REVISED:	
CHECKED BY:		REVISED:	
SCALE:		SCALE:	
DATE:		SCALE:	

EXCLUSIVE RIGHTS
THIS DRAWING IS THE EXCLUSIVE PROPERTY OF IST SURFACE, INC. INFORMATION CONTAINED HEREIN CAN BE USED ONLY WHEN SPECIFICALLY AUTHORIZED BY IST SURFACE, INC. POSSESSION OF THIS DRAWING DOES NOT CONSTITUTE AN ENDORSEMENT OR A RECOMMENDATION BY IST SURFACE, INC.

TOLERANCE OF FABRICATIONS
 TOLERANCE OF FABRICATIONS: ±0.005"
 TOLERANCE OF SURFACE FINISH: ±0.005"
 TOLERANCE OF DIMENSIONS: ±0.005"
 TOLERANCE OF WEIGHT: ±0.005"
 TOLERANCE OF PLACEMENT: ±0.005"

International Surface Technologies
 346 N. 6th St. Suite 500
 Orem, UT 84057
 TEL: 801-225-4400
 FAX: 801-225-3322
 WWW: www.istsurface.com
 TEL: 1-800-387-1085



ELECTRICAL SCHEMATIC - 1 PH / 120 V - DRAWING

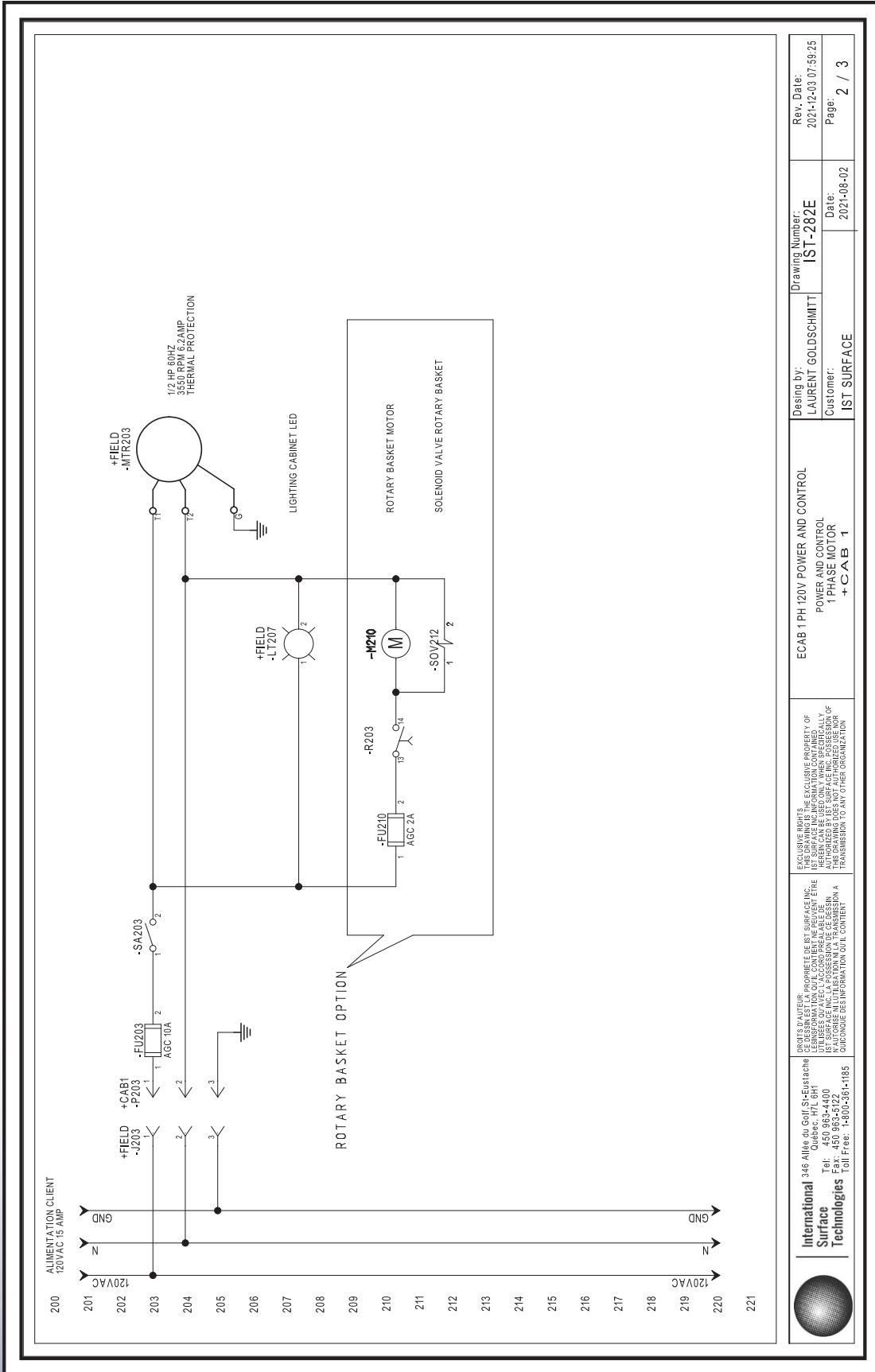



ISTBLAST LIMITED WARRANTY

ISTblast warrants all equipment led in this manual which is manufactured by ISTblast and bearing its name, to be free from defects in material and workmanship on the date of sale by an authorized ISTblast distributor to the original purchaser for use. Notwithstanding any special, extended or limited warranty published by ISTblast will, for a period of TWENTY FOUR (24) months from the date of sale, repair or replace any part of the equipment determined by ISTblast to be defective. This warranty applies only when the equipment is installed, operated and maintained in accordance with ISTblast's written recommendations.

This warranty does not cover, and ISTblast shall not be liable for general wear and tear, or any malfunction, damage or wear caused by faulty installation, misapplication, abrasion, corrosion, inadequate or improper maintenance, negligence, accident, tampering, or substitution of non- ISTblast component parts. Nor shall ISTblast be liable for malfunction, damage or wear caused by the incompatibility with ISTblast equipment with structures, accessories, equipment or materials not supplied by ISTblast, or the improper design, manufacture, installation, operation or maintenance of structures, accessories, equipment or materials not supplied by ISTblast.

This warranty is conditioned upon the prepaid return of the equipment claimed to be defective to an authorized ISTblast distributor for verification of the claimed defect. If the claimed defect is verified, ISTblast will repair or replace free of charge any defective parts. The equipment will be returned to the original purchaser, transportation prepaid. If the inspection of the equipment does not disclose any defect in material or workmanship, repairs will be made at a reasonable charge, which charges may include the costs of parts, labor, and transportation.

THIS WARRANTY IS EXCLUSIVE, AND IS IN LIEU OF ANY OTHER WARRANTIES, EXPRESSED OR IMPLIED, INCLUDING BUT NOT LIMITED TO WARRANTY OF MERCHANTABILITY OR WARRANTY OF FITNESS FOR A PARTICULAR PURPOSE.

ISTblast's sole obligation and the buyer's sole remedy for any breach of warranty shall be as set forth above. The buyer agrees that no other remedy (including, but not limited to, incidental or consequential damages for lost profits, lost sales, injury to person or property, or any other incidental or consequential loss) shall be available. Any action for breach of warranty must be brought forward within two (2) years of the date of sale.

ISTblast MAKES NO WARRANTY, AND DISCLAIMS ALL IMPLIED WARRANTIES OF MERCHANTABILITY AND FITNESS FOR A PARTICULAR PURPOSE, IN CONNECTION WITH ACCESSORIES, EQUIPMENT, MATERIALS OR COMPONENTS SOLD BUT NOT MANUFACTURED BY ISTblast. These items sold, but not manufactured by ISTblast (such as electric motors, switches, hose, etc.), are subject to the warranty, if any, of their manufacturer. ISTblast will provide the purchaser with reasonable assistance in making any claim for breach of these warranties.

LIMITATION OF LIABILITY

In no event will ISTblast be liable for indirect, incidental, special or consequential damages resulting from ISTblast supplying equipment hereunder, or the furnishing, performance, or use of any products or other goods sold hereto, whether due to a breach of contract, breach of warranty, the negligence of ISTblast, or otherwise.

Report all accidents or "near misses" which involve ISTblast products to:

- Technical Assistance

The following items are not covered under the ISTblast warranty policy:

- Parts or chassis replacement due to normal wears.

Defective material or workmanship is not considered normal wear



ISTBLAST WARRANTY REGISTRATION

Please fill out the form below and send it to us by mail, email or fax so we can register your product and keep you updated on the latest regulations released by the EPA. We thank you for your purchase and remain at your entire disposal for any further query regarding the operation of your equipment.

COMPANY NAME : _____

ADDRESS : _____

CITY : _____ STATE/PROV. : _____

COUNTRY : _____ ZIP CODE : _____

CONTACT : _____

TEL. NUMBER: _____ EMAIL : _____

FAX NUMBER: _____

PURCHASE FROM: _____

DATE OF PURCHASE: _____
Month Day Year

SERIAL NUMBER: _____ - _____ - _____ MODEL NUMBER: _____

TYPE OF MEDIA USED: _____

Which factors most influenced your decision to purchase this ISTblast unit?

SUGGESTIONS ABOUT THE EQUIPMENT: _____

Please fill out the form below and send it to us by mail, email or fax so we can register your product and keep you updated on the latest regulations released by the EPA. We thank you for your purchase and remain at your entire disposal for any further query regarding the operation of your equipment.

Fax : 450 963-5122
Email: info@istsurface.com

