

SOLVENT RECYCLER
SR240-240V



- Warranty
- Safety
- Operation
- Service Parts
- Accessory Information
- Registration Form



Safety standards :
Manufactured according to
directive 98/37/CE – 7323EEC
– 89/336/EEC – 94/9/CE

INSTRUCTION MANUAL

TABLE OF CONTENTS

	Page
LIMITED WARRANTY	4
SOLVENT RECYCLER SPECIFICATIONS	5
SAFETY AND WARNINGS	6, 7
SAFETY RULES (CONT'D).....	8, 9
DISTILLATION OPERATING PRINCIPLE.....	10
GOALS	11
WARNINGS	12
ENVIRONMENTAL PROTECTION - INSTALLATION.....	13
ELECTRICAL CONNECTIONS.....	14
INSTALLATION DRAWINGS AS PER NFPA	15
KEYBOARD OPERATIONS	16 to 17
STARTING PROCEDURES.....	18 to 20
TEMPERATURE AND CYCLE TIME SELECTION.....	21
SELECTING TEMPERATURE AND DURATION OF THE CYCLE.....	20, 21
OPTION AUTO-FILL : STARTING PROCEDURES.....	22, 23
FLAMMABLE SOLVENTS - NON - FLAMMABLE CHLORINATED SOLVENTS.....	24, 25
THERMIC OIL CHANGING PROCEDURES.....	26
KEYBOARD ERROR CODES - TROUBLESHOOTING.....	27 to 30
SCHEMATIC OF UNIT - FRONT VIEW	31
SCHEMATIC OF UNIT - SIDE VIEW.....	32
SCHEMATIC OF UNIT - OIL CHAMBER	33
SCHEMATIC OF UNIT - REAR VIEW	34
SCHEMATIC OF UNIT - CONTROL BOARD.....	35
SCHEMATIC OF UNIT - POWER SUPPLY KIT	36
OPTIONAL CRANE LIFTING DEVICE	37
OPTIONAL EQUIPMENT SECTION - LOADIND, UNLOADING & AU TO FILL UP	38
OPTIONAL EQUIPMENT SECTION - OPTION OIL COOLING	39 to 42
ELECTRICAL LIGHTS BOX & SLUDGE MONITORING SAFETY DEVICE.....	43

TABLE OF CONTENTS

	Page
<u>DOUBLE DIAPHRAGM PUMP MODEL A050 M 12.7 mm</u>	
CAUTION & WARNING	44
MODEL DESIGNATION MATRIX & REPAIR KITS - BOLTED PLASTIC	45
PRINCIPLES OF OPERATION	46
1/2" PUMP DIMENSIONS & PERFORMANCE CURVES.....	47
INSTALLATION	48
TROUBLESHOOTING	49
MAINTENANCE	50
REPAIR AND ASSEMBLY : PUMP WET END REMOVAL.....	51,52
REPAIR AND ASSEMBLY : AIR VALVE	53, 54
REPAIR AND ASSEMBLY : PILOT VALVE	55, 56
EXPLODED VIEW	57
APARTS LIST	58, 59
WETTED ELASTOMERS.....	60
WARRANTY AND REGISTRATION	61

ELECTRICAL DRAWING 380 V - 50 HZ.....	62
ELECTRICAL BOX GRM (EB1).....	63
ELECTRICAL BOX GRB (EB2)	64
ELECTRICAL BOX GRK (EB3)	65
ELECTRICAL BOX GRH (EB4)	66
LIGHT OPTION KIT.....	67
LOADING AND UNLOADING DIAGRAM.....	68
VACUUM OPTION DIAGRAM.....	69
SLUDGE OPTION TEMPERATURE DIAGRAM.....	70
LOADING-UNLOADING & AUTOFILLUP DIAGRAM SR180.....	71
OPTION OIL COOLING - PNEUMATIC DIAGRAM	72
OPTIONAL VACUUM DISTILLATION SECTION	73, 74
OPERATING PRINCIPLES - VACUUM DISTILLATION & OPERATING METHODS.....	75
OPERATING PRINCIPLES - VACUUM DISTILLATION TROUBLESHOOTING.....	76
WARRANTY REGISTRATION.....	77
INFORMATION / TECHNICAL ASSISTANCE.....	78
OUR MAP LOCATION.....	79
ABOUT THE COMPANY.....	80

LIMITED WARRANTY

ISTpure warrants all equipment led in this manual which is manufactured by ISTpure and bearing its name, to be free from defects in material and workmanship on the date of sale by an authorized ISTpure distributor to the original purchaser for use. Notwithstanding any special, extended or limited warranty published by ISTpure will, for a period of TWELVE (12) months from the date of sale, repair or replace any part of the equipment determined by ISTpure to be defective. This warranty applies only when the equipment is installed, operated and maintained in accordance with ISTpure's written recommendations.

This warranty does not cover, and ISTpure shall not be liable for general wear and tear, or any malfunction, damage or wear caused by faulty installation, misapplication, abrasion, corrosion, inadequate or improper maintenance, negligence, accident, tampering, or substitution of non-ISTpure component parts. Nor shall ISTpure be liable for malfunction, damage or wear caused by the incompatibility with ISTpure equipment with structures, accessories, equipment or materials not supplied by ISTpure, or the improper design, manufacture, installation, operation or maintenance of structures, accessories, equipment or materials not supplied by ISTpure.

This warranty is conditioned upon the prepaid return of the equipment claimed to be defective to an authorized ISTpure distributor for verification of the claimed defect. If the claimed defect is verified, ISTpure will repair or replace free of charge any defective parts. The equipment will be returned to the original purchaser, transportation prepaid. If the inspection of the equipment does not disclose any defect in material or workmanship, repairs will be made at a reasonable charge, which charges may include the costs of parts, labor, and transportation.

THIS WARRANTY IS EXCLUSIVE, AND IS IN LIEU OF ANY OTHER WARRANTIES, EXPRESSED OR IMPLIED, INCLUDING BUT NOT LIMITED TO WARRANTY OF MERCHANTABILITY OR WARRANTY OF FITNESS FOR A PARTICULAR PURPOSE.

ISTpure's sole obligation and the buyer's sole remedy for any breach of warranty shall be as set forth above. The buyer agrees that no other remedy (including, but not limited to, incidental or consequential damages for lost profits, lost sales, injury to person or property, or any other incidental or consequential loss) shall be available. Any action for breach of warranty must be brought forward within one (1) year of the date of sale.

ISTpure MAKES NO WARRANTY, AND DISCLAIMS ALL IMPLIED WARRANTIES OF MERCHANTABILITY AND FITNESS FOR A PARTICULAR PURPOSE, IN CONNECTION WITH ACCESSORIES, EQUIPMENT, MATERIALS OR COMPONENTS SOLD BUT NOT MANUFACTURED BY ISTpure. These items sold, but not manufactured by ISTpure (such as electric motors, switches, hose, etc.), are subject to the warranty, if any, of their manufacturer. ISTpure will provide the purchaser with reasonable assistance in making any claim for breach of these warranties.

LIMITATION OF LIABILITY

In no event will ISTpure be liable for indirect, incidental, special or consequential damages resulting from ISTpure supplying equipment hereunder, or the furnishing, performance, or use of any products or other goods sold hereto, whether due to a breach of contract, breach of warranty, the negligence of ISTpure, or otherwise.

Report all accidents or "near misses" which involve ISTpure products to :

- Technical Assistance

The following items are not covered under the ISTpure warranty policy :

- Parts or chassis replacement due to normal wears.

Report all accidents or negligence involving ISTpure products to our Service Department :

1 877 629-8202

SOLVENT RECYCLER SPECIFICATIONS

SPECIFICATIONS	
Units system	Metric
Geometrical capacity of boiler	292 L
Useful capacity of boiler	240 L
Operating temperature	40-180 °C
Solvent protection	Solvent protection (zone 1)
Solvent temperature	310 °C
Absolute operating pressure	223 – 1,000 hPa
	170 –760 mmHg
	-0.223 – 1 bar
Relative operating pressure	-776 – 0 hPa
	-590 – 0 mmHg
	-0.776 – 0 bar
Time per cycle of distillation	3.5 to 4.5 hours (estimate)
Yield	85 % — 97 %
Cooling system	Motor Fan 746 W
Boiler material	Stainless steel AISI 304
Cover material	Stainless steel AISI 304
Condenser material	Copper (standard) / Stainless steel (optional)
Voltage	380 V - 30 A – 3 Ph – 50 Hz
Power consumption	18,000 W
Nominal amperage (380 V)	40 A
Thermic oil capacity	Refer to the Nameplate
Dimensions (D x W x H) (mm)	1190 x 2100 x 2020
Weight	586 kg
Warranty	12 month standard, warranty additional 12 month extension with returned warranty card on parts only.

SAFETY AND WARNINGS

GENERAL SAFETY

1. Carefully inspect the shipping crate for any signs of transport damage. The damage to the crate often indicates possibility of transport damage to the equipment inside.
2. Carefully remove your ISTpure Recycler Cabinet from the shipping crate.
3. Check your equipment immediately to ensure that it is free of transport damage. Report any transport damage to the carrier without delay for possible claim procedures, ISTpure is not responsible for damage to equipment after it leaves our warehouse.
4. Check the equipment list and compare it with the parts you have received. If any parts are missing, contact the supplier you purchased the equipment from.

Before operating the ISTpure recycler, read this instruction manual completely. All ISTpure products are engineered and manufactured to the highest performance standards and have been subjected to detail testing before shipment from the factory.

DANGER AND WARNING LABELS

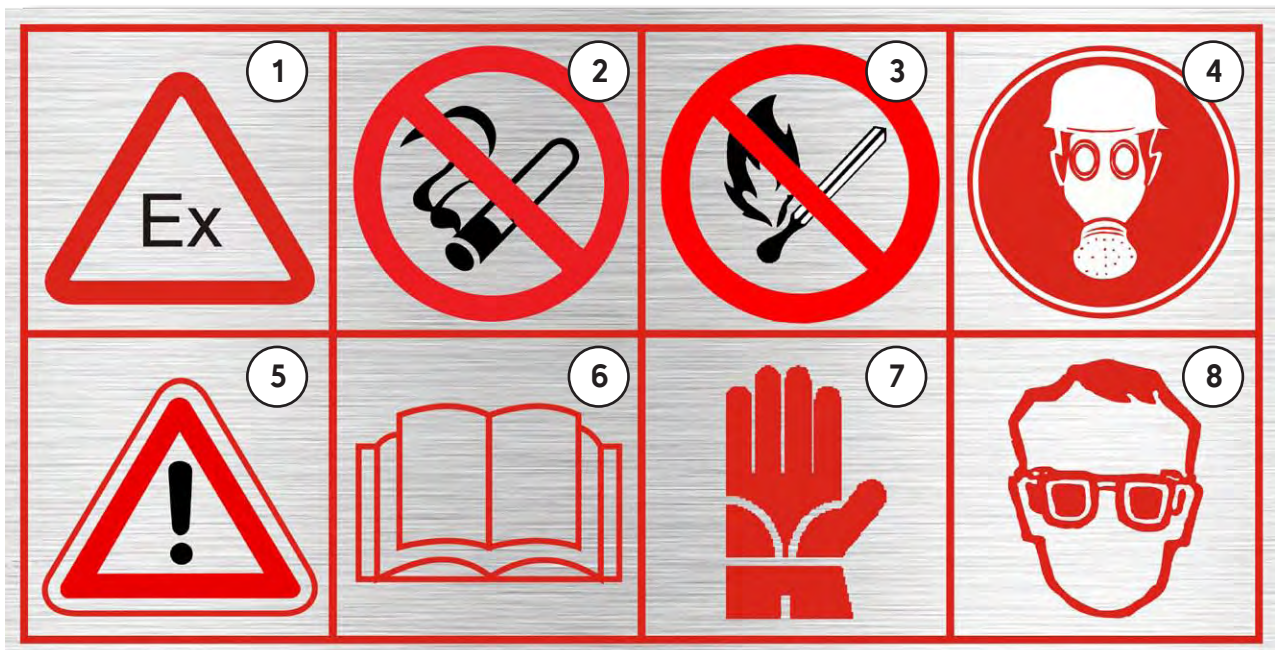

- | | |
|--|---|
| 1. Presence of flammable vapors and solvents | 5. Observe warnings at all times. |
| 2. No smoking or metal grinding nearby | 6. Read the Instruction Manual carefully. |
| 3. Keep away from open flames | 7. Wear solvent-proof rubber gloves. |
| 4. Wear breathing mask | 8. Wear protective eyewear before use. |

SAFETY AND WARNINGS (CONT'D)

WARNING

« READ ALL INSTRUCTIONS » Failure to follow the **SAFETY RULES** identified by a **BULLET (•)** symbol listed **BELOW** and other safety precautions may result in serious personal injury.

“ SAVE THESE INSTRUCTIONS “

GENERAL SAFETY RULES

- **KEEP WORK AREA CLEAN.**
- **KEEP CHILDREN AWAY.** Do not let visitors come in contact with the equipment. All visitors should be kept away from the work area.

PERSONAL SAFETY

- **DRESS PROPERLY.** Do not wear loose clothing or jewelry. They can be caught in the moving parts. Wear protective hair covering to contain long hair.
- **USE SAFETY EQUIPMENT. WEAR SAFETY GOGGLES** or glasses with side shields and breaking mask.
- **STAY ALERT. USE YOUR COMMON SENSE.** Concentrate on what you are doing. Do not operate the unit when you are tired or under the influence of drugs or alcohols.
- **DO NOT OVERREACH.** Keep proper footing and balance at all times.

UNIT USE AND CARE

- **DO NOT FORCE THE UNIT.** It will perform better and safer at the rate for which it was designed.
- **THE USE OF ANY OTHER ACCESSORIES** not specified in this manual may create a hazard.
- **CLOSE THE MAIN AIR SUPPLY VALVE AND MAIN POWER DISCONNECT BEFORE SERVICING** or when not in use.
- **DO NOT ALTER OR MISUSE THE UNIT.** These units are precision built. Any alteration or modification not specified is misuse and may result in a dangerous situation.
- Only trained repairmen should attempt (•) **ALL REPAIRS**, electrical or mechanical. Contact the nearest IST-pure repair service facility. Use only ISTpure replacement parts, any other parts may create a hazard.

SAFETY RULES (CONT'D)

THE OPERATOR MUST WEAR protective water-proof rubber gloves to prevent contact between his hands and the products used for cleaning.

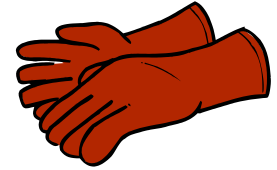

THE OPERATOR MUST WEAR protective eyewear to prevent spatter from coming in contact with his eyes.

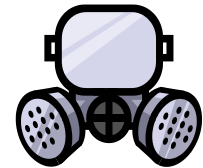

STAY ALERT at the start of the wash cycle. Make sure the liquid solution is not «corrosive» or flammable. Immediately stop the using and replace the solvent whenever you note signs of corrosion on the unit.

IF EYES COME IN CONTACT WITH SOLVENTS rinse thoroughly with water.

BEFORE USING the Solvent Recycler, make sure that all safety devices are in perfect operating condition.

BECOME FAMILIAR WITH THE CONTROLS and their functions before commencing work.

BE CAREFUL when you load or unload the solvent in the unit. Make sure you do not splash or spill the contents on the workshop floor.

THE OPERATOR MUST PERIODICALLY check the level of the solvent contained in the equipment to be sure to not run this pump dry.

DO NOT USE ELECTRICAL OR PNEUMATICAL TOOLS WITH THE UNIT. AVOID GASEOUS AREAS. Do not operate portable electric tools in explosive atmospheres in the presence of flammable liquids or gases. Motors in these tools normally spark, and do not scrape or scratch the machine with metal objects; the sparks might ignite fumes.



DO NOT ALLOW FAMILIARITY GAINED FROM FREQUENT USE OF YOUR RECYCLER TO BECOME COMPLACENT. Always remember that a careless fraction of a second is sufficient to inflict severe injury.

DO NOT ALTER OR MISUSE THE UNIT. Any alteration or modifications is a misuse and may result in serious personal injuries.

SAFETY RULES (END)

COMPLY WITH LAWS IN THE COUNTRY where the washer is installed regarding the use and disposal of the products used to wash clean objects.

FIRE EXTINGUISHING SYSTEMS must be installed in the same room or close to the unit in case of emergency.

These appliances must be well maintained and inspected every year by a qualified personnel.



THE INSTALLATION SITE MUST PERMIT PERSONNEL TO EASILY AND QUICKLY MOVE AWAY FROM DANGER ZONES IN CASE OF AN EMERGENCY.



DO NOT USE THE UNIT TO wash or degrease objects designed to come in contact with food.

COMPLY WITH LAWS IN THE COUNTRY where the Solvent Recycler is installed regarding the use and disposal of the products used to wash clean objects.

DO NOT USE UNSTABLE REACTIVE
avoid distilling solvent that may include unstable reactives, such a nitrocellulose.



THINK SAFETY! SAFETY IS A COMBINATION OF THE OPERATOR'S COMMON SENSE, KNOWLEDGE OF THE SAFETY AND OPERATING INSTRUCTIONS AND ALERTNESS AT ALL TIMES WHEN THE UNIT IS IN OPERATION.

DISTILLATION OPERATING PRINCIPLES

This PLC controlled solvent recycler, will recycle many different types of solvents that have been contaminated by paints, pigments, inks, greases, oils, etc. Through the simple distillation process, the recycler separates the contaminants from the original solvent.

The boiling of the polluted solvents consists of a boiler surrounded by a reservoir containing thermal oil, heated by an electrical resistance. The solvent vapors produced in the boiler are eventually conveyed in an solvent cooled drum and then brought back to their liquid state. The cooled solvent is gathered in a clean stainless steel collecting tank, ready to be re-used again. The process does not alter the characteristics of the distilled solvent. Consequently, the operation can be performed endlessly.

The residues remains inside the boiler and can be unloaded when cold. It is recommended to use a liner bag (**Part# 300026**), for information contact the authorized reseller to be placed inside the boiler. These bags facilitate the unloading of residues at the end of the distillation cycle.

The cycle is completely automatic. The operator only has to close the lid, touch the **START** button and remove the residues at the end of the cycle.

In case of malfunction, abnormal increase of temperature or power failure, the cycle is automatically **STOPPED** and the recycler **CANNOT** be re-started until the problem has been resolved.

GOALS

The goals that can be achieved with ISTpure distillation units are :

1. Solvent recycling with the highest yield possible.
2. Obtaining «special» and not «toxic and noxious» residues.
3. Reducing intervention times and operator discomforts.

Solvent and contamination product topologies are so different that there are no general rules that can apply for all cases. This manual will provide general information that may be useful to your specific situation to which you can adapt as you gain more experience and comfort with using the distillation units.



The products to be recycled normally consist of :

Solvent or Reducer + Contaminated Products

- **Solvent**

« Solvent » defines the liquid, which, without reacting chemically, dissolves other substances (solutes), forming a solution.

As every solvent has its own boiling temperature, we must (in order to distill the solvents) set the thermostat at a higher working temperature of about 10 °C to 50 °C than the boiling point.

- **Reducer**

A mixture of solvent is defined as a « reducer ».

As every solvent component in the mixture has its own boiling temperature, in order to proceed to the distillation of a reducer, set the thermostat at a working temperature of about 10 °C to 50 °C higher than the boiling point of the most high-boiling solvent.

GOALS (CONT'D)

- **Chlorinated Solvents (these solvents can be recycled with the SR30V–SR60V–SR120V or SR180V only)**

Chlorinated Solvents are **non-flammable solvents**, generally utilized for cleaning and degreasing metal surfaces. Normally, these types of solvents are polluted by **oil, grease**, etc.

Atmospheric pressure distillation of chlorinated solvents will result in a partial recovery, leaving a distillation residue containing about 20% of solvents. This occurs when the oil contents in the boiling solution increases; therefore the mixture distillation temperature rises.

These solvents are thermalable, meaning that when they exceed their specific critical temperature they decompose causing the formation of hydrochloric acid. This acidifies the product and therefore cannot be reused. When operating with atmospheric pressure, and reaching this critical temperature, we shall have distilled only 80% of the solvent.

Operating with a vacuum will allow you to achieve a yield of 100%, as you do not reach the critical temperature (vacuum kit is optional).

- **Liquid Polluting Products**

The most common liquid contamination products are :

Oil, Ink and Water

The presence of liquid contamination may (in the distillation phase) drag contaminants into the clean product, leaving traces in the distillate.

For different types of oil and ink with particularly high boiling temperature, this problem normally does not occur and the process of separation may be obtained with a simple distillation.

If there is « **water** » in the contaminated product, you **must recycle** with a **fractional distillation**. This operation is not possible with a simple distillation process.

Unloading a liquid polluting product from the recycler presents no problem. It is possible to obtain a complete separation of the polluting product from the reducer.

This complete separation is not possible when **Chlorinated Solvents** are to be distilled under atmospheric pressure.

For these solvents it is necessary to proceed with a « **vacuum** » distillation. This process allows you to obtain a residue without solvent.

- **Solid Polluting Products**

The most common solid polluting products are :

Resins, Pigments, Paints, Polymers, Glue, Powder, Grease, etc.

Solid polluting products, according to their nature, already classified as «toxic and noxious» have the advantage (in comparison to liquid contamination products). They can be unloaded into controlled waste dumps, as they do not release toxic substances into the ground. However, this is on the condition that the percentage of solvent will not exceed that of the Concentration Limit (CL) – a value legally stabilized for different types of solvents used in different Countries.

By distillation, and this is another considerable advantage, you can obtain an extremely pure distilled product as there will be no contaminants dragged into the distilled product.

The disadvantage, in comparison with liquid polluting products, is a greater difficulty in cleaning the distillation unit.

Leave a minimal percentage of solvent (3-10%) with the contaminants in the solution of residue, in order to obtain a semi-solid residue, and therefore will be easily discharged.

These percentages, however, are greater than the Concentration Limit (CL) accepted for the disposal in controlled dumps.

WARNINGS

The operating staff must be fully instructed on the use and function of the unit as well as on the correct application of the protection devices. The instructions must be repeated in regular intervals.

It is essential to keep the Instruction Manual inside the door slot or close to the unit.

Operator must wear anti-static clothes, avoiding clothes made of synthetic material (nylon, rayon, etc.).

Open the cover only after the unit has cooled down, with the control board indicating less than 100 °C.

When unloading residues, it is recommended to use solvent resistant gloves and an anti-vapor mask.

Do not use any metallic tools as they could provoke sparks.

The unit must undergo a revision and control according to its grade of use. Maintenance must be carried out by qualified personnel and according to the indications of the Manufacturer.

It is important to pay attention to the control of the security installations: thermostats, flow controls, thermocouple detectors, switches of safety levels, aspirators, etc.

Before using a distillation unit, which has been out of use for a long time, it must be checked and brought back into optimal condition in order to guarantee the operator's security at all times.

According to the type of liquid to be distilled and the kind of operation to be performed, it is important to adopt adequate personal protection rules.

If you are not using plastic bags, the residues must be cleaned with tools that do not provoke sparks.

The cover works as a safety valve. If you notice steam leaking from the cover, immediately shut down the recycler and consult page 25, « **Troubleshooting** ». In any case, never modify in any way the parts on top of the cover or block the cover in order to avoid the steam from leaking.

Nitrocellulose which is an ester of cellulose and nitric acid is a component found in many lacquers, inks, adhesives and cements cannot be recycled. It automatically **ignites** at 135–166 °C and can be extremely volatile.

It is important to clean the boiler thoroughly after each cycle, as a build up of residue will stop the transmission of heat and cause a malfunction.

If repairs are necessary shut off the power supply **IMMEDIATELY**.

Do not smoke, cause sparks or use open flames near the recycler.

This unit is for use in a 40 °C environment with no forced ventilation. Under these conditions, the unit shall be spaced a minimum space according to national regulation from potential sources of ignition such as electrical receptacles, switches, pilot light fixtures, contacts and other similar equipment that can produce sparks. If the equipment is used in higher ambient temperatures an increase in spacing from sources of ignition shall be considered.

This unit has been tested for use with the solvents indicated in the instruction manual (see tables on pages 23–24, « **Flammable Solvents and Non-Flammable Chlorinated Solvents** »).

ENVIRONMENTAL PROTECTION

The user must ensure the protection of the environment so that the recycler can not be the cause of vapor emissions or odors. The use must ensure that the residues are treated and disposed of according to local standards.

INSTALLATION

If the unit is installed in a small closed room like 3 m x 3 m than it has sufficient natural or artificial air ventilation. If installed in explosion proof room or mixing room for paint ink, there is no need to add additional ventilation.

Places and zones with sufficient artificial air ventilation are those with such ventilation capacity as to change air circulation ten times per hour. The outlet of the unloading air channels must be placed in a way that the evacuation of emerging vapors does not cause any form of danger.

Complete air circulation should be provided in case of artificial air ventilation.

Air ventilators or their motors should be explosion proof.

Make sure that the emergency exit is easily accessible.

The distillation unit must be positioned near one door that leads to an exit door.

Place a fire extinguisher near the unit (for fire type B and C).

Keep a distance of at least 610 mm between the unit and any object to allow the recycler to cool off, and be able to perform the maintenance if necessary.

Place the unit on a flat surface away from heat, sparks and any source of flames.

Connect permanently the unit to an efficient grounding pole.

Place a container of at least twice the capacity of the boiler, 484 L or more.

The power outlet is located on the back of the unit. The unit should be permanently connected into a explosion proof electrical line :

- **40 A - 3 Ph - 380 V**

When service or maintenance work is required, disconnect the main breaker switch before servicing or for maintenance work.

Note : If the unit is equipped with the Sludge Monitoring Safety Device, make sure to use an inline filter on your water supply to trap debris upstream from the valve.

ELECTRICAL CONNECTIONS

The Zone 1 electrical connections must be performed by a certified electrician.

For the current and voltage specifications, refer to the nameplate on the right side panel.



It is recommended to locate the above-mentioned electrical box, at a height of 1.5 to 1.8 meters from the floor.

N.B. : An adequate explosion installation must be provided for the solvent recycler and all other components around (for example: protection type Zone 1, with increased safety).

Once the electrical connections are complete, open the main breaker for the recycler and the keyboard light will be « **ON** ».

Each time the power is closed and re-opened, the ISTpure electronic keyboard will enter a self-test mode. During 5 seconds, all 5 lights and all 5 digits of 7 segment lights will stay on. Then the keyboard will display its own programming version (example: r 6.0) for a few seconds and then the thermometer light will stay « **ON** » and the actual temperature of the thermic oil will be displayed.

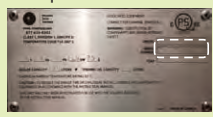
The control board is « **READY** » for instructions.

DATA & SPECIFICATIONS						
Electrical Requirements						
Amp Draw listed for entire unit — including motor and heating element						
MODEL	Full load Amp Draw			Location		
	220V	480V	600V	Non-classified area	In mix room/classified area	
SR	11.7	—	—	<ul style="list-style-type: none"> • General purpose disconnect • Min. 5 ft away from unit • Min 18" off the floor 	Explosion proof disconnect required	
SR	23.4	—	—			
SR	—	14.5	11.3			
SR	—	20.8	15.0			
SR	—	24.8	19.5			
SR	—	24.8	19.5			
Air Requirements						
ITEM	Air Line Specifications	cfm	Notes			
SR30V-60V	3/8" @ 100 psi	5	Factory set at 85-90 psi			
SR120V-180V	1/2" @ 100 psi	10				
SR120V-180V	1/2" @ 100 psi	10				
SR	240	1/2" @ 100 psi				
Thermal Heat Transfer Oil						
Model	Oil Capacity	Parts Number				
SR30 TO SR240	Please refer to your product identification plate for required oil volume. 	Standard	High Temp	Volume		
		330066	330166	1 gal / 4 L		
		330067	330167	2.9 gal / 11 L		
		330068	330168	5 gal / 19 L		
		330069	330169	55 gal / 208 L		
<div style="display: flex; justify-content: space-between;"> <div style="width: 30%;"> <p>EXCLUSIVE RIGHTS This drawing is the exclusive property of ISTpure and informations contained herein can be used only when specifically authorized by ISTpure. Possession of this drawing does not authorize use nor transmission to any other organisation.</p> </div> <div style="width: 35%; text-align: center;"> <h2 style="margin: 0;">GENERAL ARRANGEMENT</h2> </div> <div style="width: 30%; text-align: right;">  <small>1050 Des Forges Street, Hwy. 640 Industrial Park Terrebonne, Qc Tel 1 877 629-8202 • 450 963-4400</small> </div> </div>						

Recycler Bags

MODEL	Part Number
SR	300006
SR	300019
SR	300008
SR	300009
SR	300010

INFORMATION CODES

ISTpure offers a complete line of spray gun cleaners and solvents recyclers that conform to the requirements of :

- NFPA-33 Standard for spray application using flammable and combustible materials.
- NFPA-30 flammable and combustible liquid code
- IFC : International Fire Code

The recycler has been certified and listed :

- UL 2208 standard for solvent distillation unit

The recycler has been reviewed and approved by :

- QPS for U.S. & Canada requirements report #LR1558

Conformity of all these requirements is dependent upon the manner in which the equipment is installed. The contractor will make certain that all of the electrical wiring and conduit, piping, gas supply, roof penetrations, automatic fire protection systems, and the location of the equipment within the building also conforms to the cited codes and the other references.

INSTALLATION DRAWINGS AS PER NFPA (CONT'D)

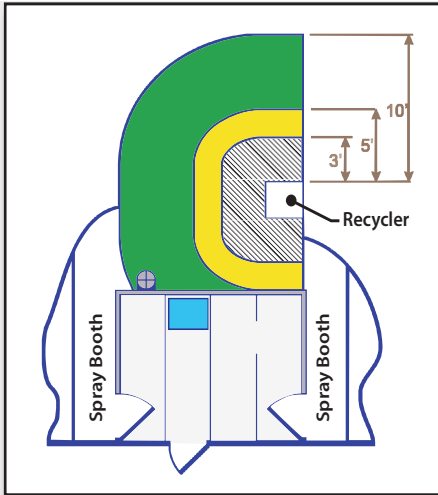

INTERMEDIATE MIX ROOM

LEGEND

-  Class 1 - Div 1
-  Class 1 - Div 2
-  Class 1 - Div 2
18" Height only

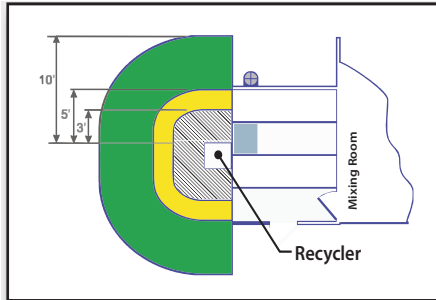

THREE SIDES MIX ROOM

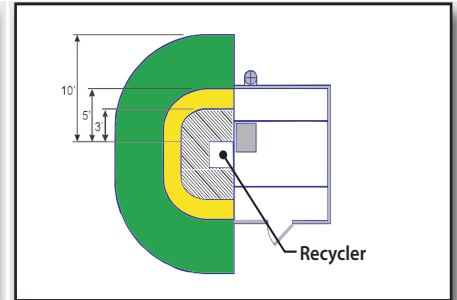

FREE STANDING MIX ROOM

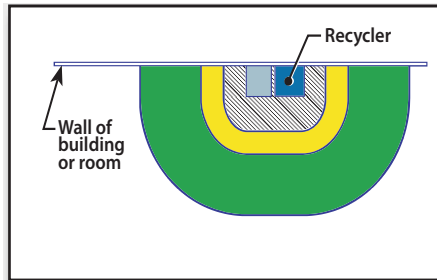

ENTIRE SYSTEM OUTSIDE MIX ROOM

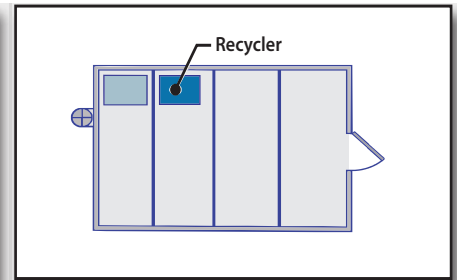

ENTIRE SYSTEM INSIDE MIX ROOM



Classification zones as per :

- A) NFPA 33 standard for spray application using flammable and combustible materials, sections 4.3.5
 - B) International fire code, chapter 34 flammable and combustible liquids 3403.11
- Zone requirements apply to both gun cleaners and recyclers together and stand alone.

EXCLUSIVE RIGHTS

This drawing is the exclusive property of ISTpure and informations contained herein can be used only when specifically authorized by ISTpure. Possession of this drawing does not authorize use nor transmission to any other organisation.

GENERAL ARRANGEMENT



1050 Des Forges Street, Hwy. 640 Industrial Park
Terrebonne, Qc Tel 1 877 629-8202 • 450 963-4400

KEYBOARD OPERATIONS

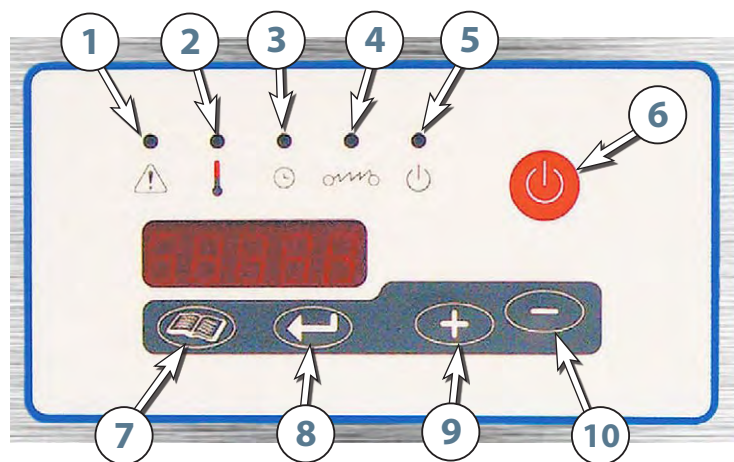

Keyboard Symbols :

1. ALARM
2. TEMPERATURE
3. TIME
4. ELECTRIC HEATER
5. START/STOP (LIGHT)
6. START/STOP (BUTTON)
7. MENU
8. ENTER
9. INCREASE
10. DECREASE

The ISTpure temperature control board has been designed to control the different cycles during the distillation process. It controls the temperature of the thermic oil, vapors and the distillate solvent coming out of the condenser. It uses this information to maintain a constant temperature, starts the cooling fan to cool the vapors coming off the condenser and stops the cycle if necessary.

Two heat sensors are used during the distillation cycle to read different temperatures. The thermic oil and the distillate solvent temperatures are captured using two thermocouples (because of high temperatures rising up to 175°C (343°F)). These sensors assure precision of the readings of the temperatures of $\pm 1^\circ\text{C}$ ($\pm 2^\circ\text{F}$).

One heat sensor is used during the cool down cycle to capture the sludge temperature inside the boiler. When the sludge achieves a safe 90 °C (194 °F), the drainage cycle starts automatically.

The ISTpure board also displays the total number of hours of operation of the recycler. For every 2000 (two thousand) hours of operation, the display code «OIL» will appear to remind you that it is time to replace the thermic oil follow the steps on page 25. The code «OIL» will remain displayed for ten (10) hours and then will disappear.









The display board consists of 5 digits of 7 segments, of 5 independent LEDs and of 5 touch-tone keys (7, 8, 9, 10 and 11) to operate the recycler. The operator can program the temperature, select the amount of time for the cycle, start or stop the cycle, choose between Celsius or Fahrenheit degrees, and if necessary, display every code to verify the operation of the recycler in case of problems.

The safety devices will stop the cycle in case one of the sensors detects any trouble. The TROUBLE light will be displayed. The recycler CANNOT be re-started until the problem has been resolved.

KEYBOARD OPERATIONS

CONVERTING BETWEEN CELSIUS AND FAHRENHEIT MODE

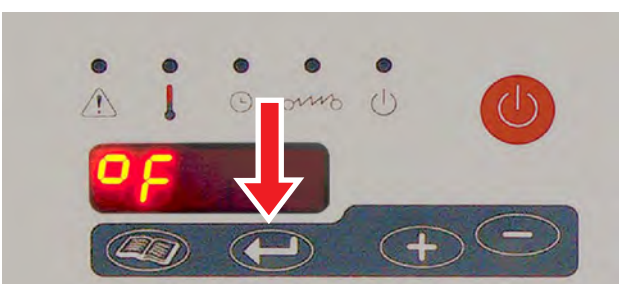
All units manufactured by ISTpure are programmed in CELSIUS degrees.

Press	Indication	Result of the keyboard
	<p>Step 1 – Press </p> <p>Press and hold the Plus sign for 7 seconds</p>	
	<p>Step 2 – Press </p> <p>PRESS AND HOLD THE Minus SIGN ONCE</p>	
	<p>Step 3 – Press the Arrow</p> <p>Confirm by pressing the arrow sign you are now in Fahrenheit</p>	
	<p>Now set up time and temperature (see page 21)</p>	

STARTING PROCEDURES

1. Preparation

- A. Position a clean solvent container (equal the capacity or greater than the boiler) on the left end side where the clear tube comes from the outlet of the condenser.
- B. The clean solvent container must have an air vent to allow normal fill-up.
- C. You must use a metallic container, and it must be connected to the ground clip supplied with the unit.

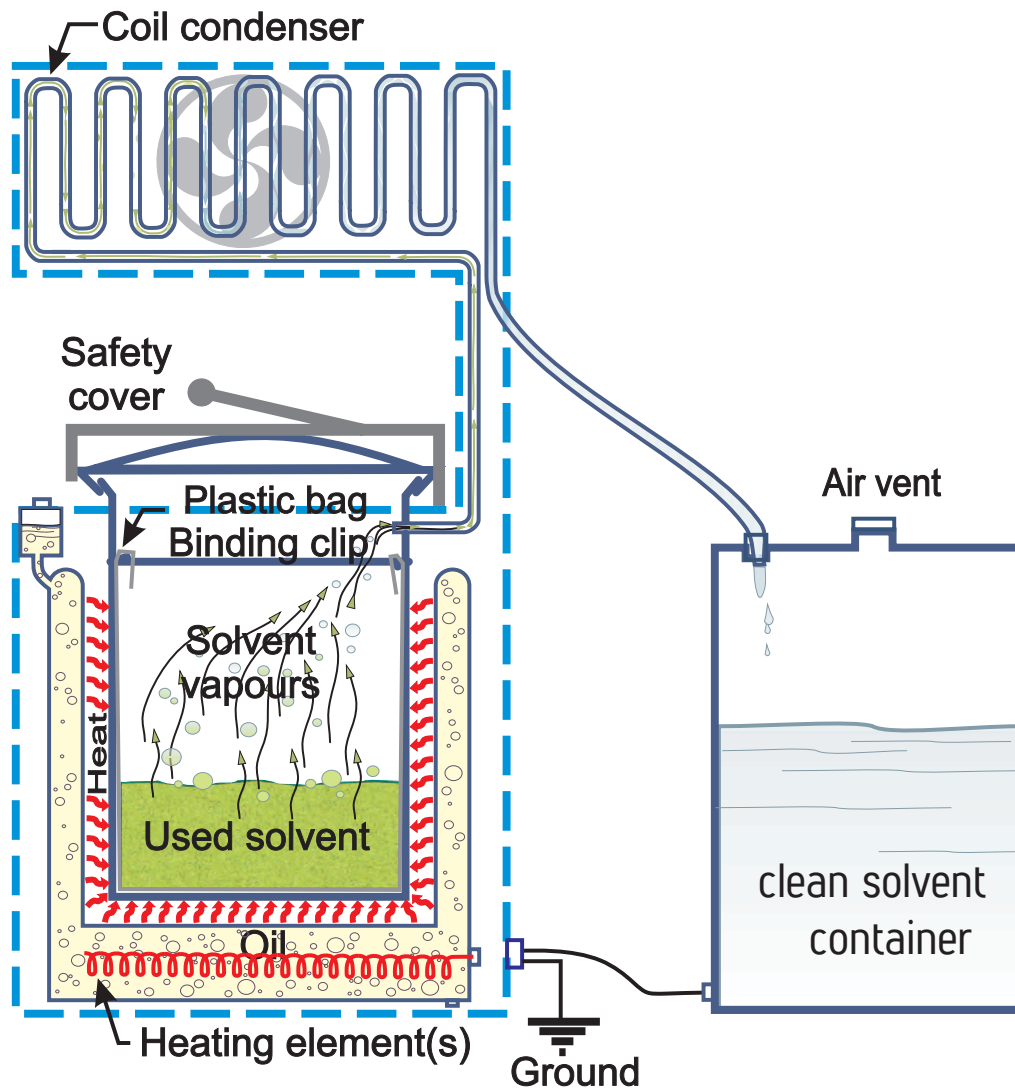

STARTING PROCEDURES (CONT'D)

1. Plastic bag installation steps

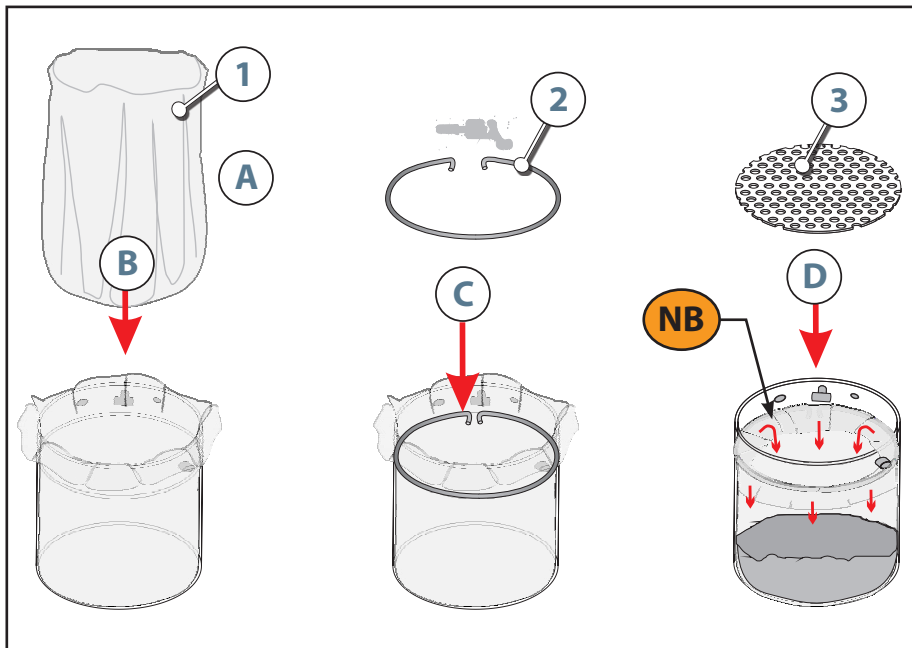

- A. Pull the bottom corner of the bag inwards.
- B. Insert the plastic bag (#1) in the boiler (#300010)
- C. Insert the retaining ring (#2) (# 323121) and insert the locking mechanism.
- D. Optional antifoam grate (#3), #324023

NB Fold the protruding portion of the bags inward as not to cover any spouts.

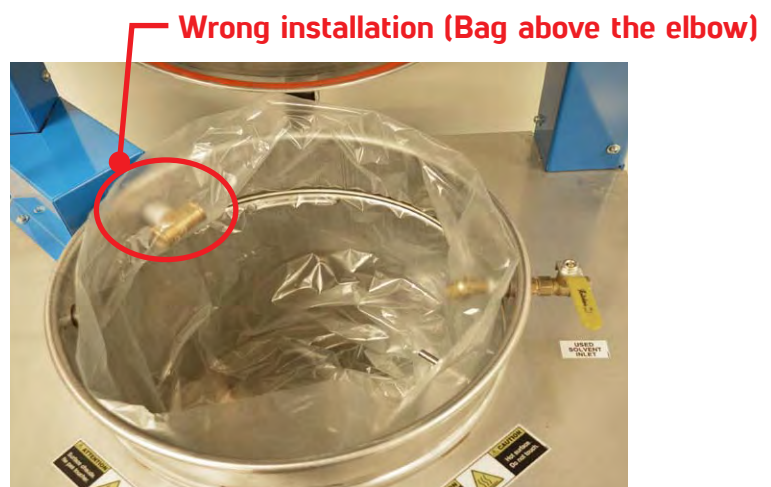

Note : the recycler shown above is a SR30, but the principle is the same for all models.

OVERFLOW PROCEDURE

If the replacement bag were to block any of the spouts found inside the boiler chamber this would create an unsafe pressure build up. A safety mechanism built into the lid would release the excess pressure and lead to a dangerous situation in which a nearby operator could be burned.

Should you experience this situation, ensure to turn off the cycle switch if safe to do so. If unable to turn off the cycle close the main circuit breaker and stay away from any solvent which may splash out of the recycler.

Important: Wait at least 1 hour before opening the unit and put on gloves and a protective mask before approaching the boiler.

STARTING PROCEDURES (END)

2. Filling up the Recycler

- A. Open the cover and manually fill the boiler with dirty solvents up to approximately 25 mm below the grooved slot mark indicating the maximum level.

Manual Mode Filling Procedures :

1. Open air pump pressure valve
 2. Open dirty solvent loading valve.
 3. The filling process will now start.
 4. Remember to shut off the dirty solvent valve when the level reaches 2 inches below the grooved slot
 5. Close the cover
 6. Press the <Start/Stop> button
 7. The <On> light will turn on
 8. The <Heating Element> light will turn on
 9. Every 5 seconds, the screen will display the following 3 readings :
 - a. Selected boiling temperature: (Thermometer light will flash).
 - b. Amount of time selected for that cycle: (Clock light will flash).
 - c. Elapsed time since starting the unit: (Clock light will be on).
 10. The recycled solvent will start dripping approximately one hour after the start-up in the internal reservoir.
 11. The recycler will stop automatically when the cycle time has ended
- B. Before closing the cover, verify the condition of the lid gasket. **It is recommended to change the oil (330068 – 6 x 19 L container) and the orange gasket seal or the black gasket seal for vacuum every 2000 hours of work or every year whichever comes first. See page 25 for oil change procedures.**
- C. **This model use a orange or black gasket cover seals.** See part numbers below :

Part # 304020 Orange Gasket Color 

Part # 304025 Black Gasket Color 

Using a non-suitable gasket will cause vapors to leak from the cover.

During the boiling phase, some solvents can foam up and lead to a decrease in the quality and quantity of solvent that can be recovered. To avoid this situation an optional anti-foam kit (part # 324023).

Pay the utmost attention while the residues are drying. Some polluting products tend to carbonize with a considerable discharge of smoke from the recycler.

In case this occurs, press the (START / STOP) button to end the cycle.

In this case it is not possible to dry the residues at atmospheric pressure; proceeding to the vacuum distillation phase may solve the problem. This technique allows you to operate at a much lower temperature.

Opening the cover before the distillation cycle is complete will cause the gasket to swell. You must wait at least one hour.











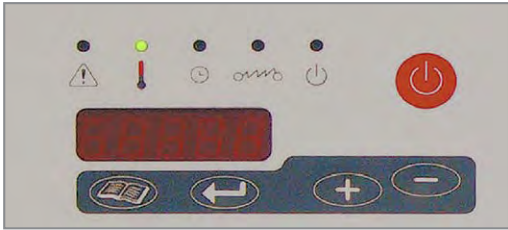

- D. Close and secure the cover properly. Your cover acts as a safety valve. **NEVER** modify the cover mechanism and **NEVER** use any tools to tighten the cover.

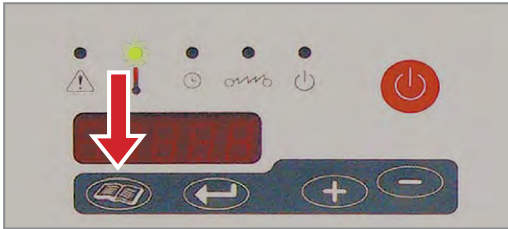
- E. **DO NOT SHAKE OR TILT** the load recycler during operation.

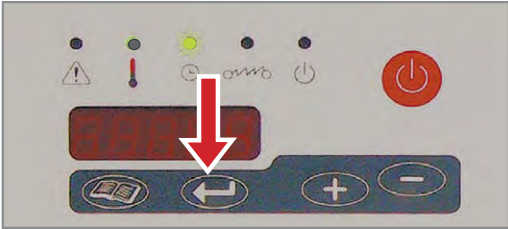

TEMPERATURE AND CYCLE TIME SELECTION

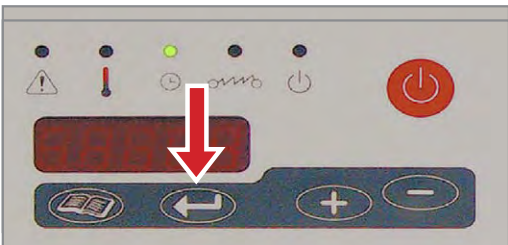
Before starting the cycle, you must select between **CELSIUS** and **FAHRENHEIT** temperatures (see p.17). Temperature settings are determined by the **BOILING POINT** of the solvent to be reclaimed. The boiling points shown are for **NEW SOLVENTS**.

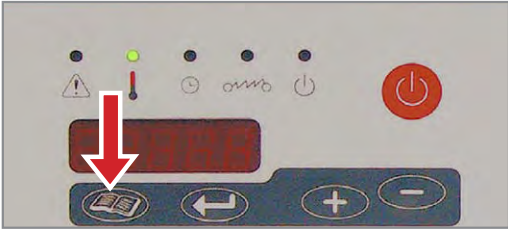
NOTE : The temperature setting starting point will vary according to the solvent used and the percentage of contaminants in the solvent.

Press	Indication	Result of the keyboard
	<p>Thermometer light is ON.</p> <p>Keyboard will display the actual temperature of the thermic oil.</p>	
	<p>Thermometer light flashes.</p> <p>You have the option to select the temperature for the cycle by pressing keys.</p> <p style="text-align: center;">  or  </p>	
	<p>You have the option to select your own amount of time for the cycle by pressing keys :</p> <p style="text-align: center;">  or  </p> <p>Recycler will automatically stop when time has expired.</p>	
	<p>Clock light is ON.</p> <p>The total amount of working hours of the recycler since day one will be displayed.</p> <p>This cannot be changed.</p> <p>For every 2,000 hours of operation the message OIL will flash to notify you to change the thermic oil.</p>	
	<p>Thermometer light is ON.</p> <p>Keyboard will display the actual temperature of the thermic oil.</p>	

STARTING PROCEDURES

Press	Indication	Result of the keyboard
	<p>Press the START/STOP key. ON light will go on.</p> <p>Electric element will start heating the thermic oil.</p> <p>Element light will go on.</p>	



DURING THE DISTILLATION CYCLE

- A. Every 5 seconds, the keyboard will display 3 different readings:
 1. Selected boiling temperature : (Thermometer light will flash).
 2. Amount of time selected for that cycle : (Clock light will flash).
 3. Elapsed time since starting the unit : (Clock light will be on).
- B. The cooling fan will start turning.
- C. The recycled solvents will start dripping approximately one hour after the start-up.
- D. At the end of the cycle, the **ON** light will flash and a count down timer will indicate the remaining time left in the cool down period (starting at 60 minutes and counting down to zero). During the cool down time the heating element will be off but the cooling fan will remain on during the cooling period. When the cycle time has ended, the display panel will indicate **-END-**.
- E. The cooling fan will automatically shut off at the end of the cooling cycle.

END OF CYCLE

- The keyboard will display the total elapsed time for that cycle.
- All lights will shut off except the ON light.
- Wait at least one hour before opening the cover.
- You can now remove the residues.
- Press the stop key. 

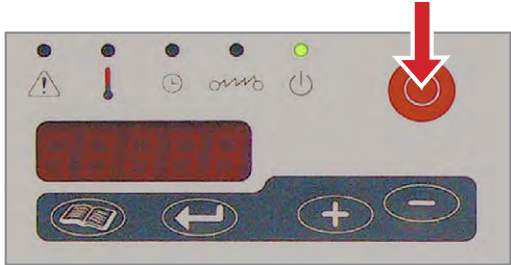
OPTION AUTO-FILL : STARTING PROCEDURES

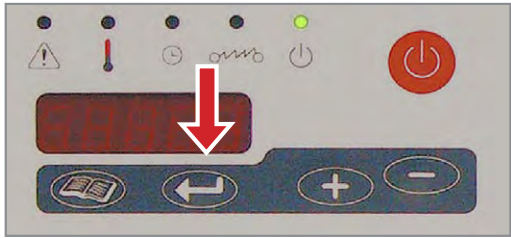
Press	Indication	Result of the keyboard
	<p>Press the START/STOP key. ON light will go on.</p> <p>Electric element will start heating the thermic oil.</p> <p>Element light will go on.</p>	
	<p>FILL signal will show on board. Make sure dirty solvent loading valve is on the ON position.</p> <p>Press the arrow to confirm you want to fill unit.</p> <p>Pump will start filling up the recycler Once unit reach level sensor ON light will go on.</p> <p>Electric element will start heating the thermic oil.</p> <p>Element light will go on .</p>	

INTERRUPT ON GOLINE IN DISTILLATION PROCESS

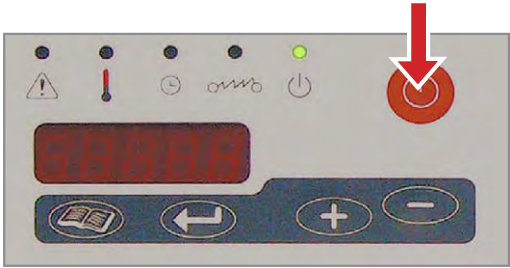
Press	Indication	Result of the keyboard
	<p>You can interrupt the distillation cycle at any time.</p> <p>The system switch to cool down mode.</p>	

FLAMMABLE SOLVENTS
(vacuum system not required)

SOLVENT TYPE	Distillation Temperature		Temperature Class	Ignition Temperature		Seal Silicone	Condenser Type	
	°C	°F		°C	°F		cop	s/st
Acetone	56	133	T-2	535	995	A	A	A
Alcohol Amyl	145	293	T-2	300	572	A		B
Alcohol Butyl	118	244	T-2	343	649	A	A	A
Methanol	65	149	T-2	440	824	A	A	A
Amyl Acetate	126-155	259-311	T-2	375	707	A	A	A
Benzol (Benzene)	80	176	T-1	498	1040	A	B	B
Butanol (Butyl Alcohol)	118	244	T-2	366	691	A	A	A
Butyl Acetate	128	262	T-2	370	698	A	B	A
Cabinol	65	149	T-2	385	725	A	B	A
Cellosolve Acetate	156	313	T-2	377	711	A	B	A
Cyclohexanone	155	311	T-2	419	786	A	B	A
Ethyl Acetate	79	174	T-2	427	801	A	A	A
Ethyl Alcohol (Ethanol)	79	175	T-2	362	684	A	A	A
Ethyl Benzene	136	277	T-1	466	871	A	A	A
Ethyl Glycol Acetate	156	313	T-2	377	711	A		
Heptane	98	208	T-2	220	428	B	A	A
Iso Amyl Acetate	125-155	257-311	T-2	375	707	A		A
Iso Butyl Acetate	104-119	219-246	T-2	420	788	A		
Iso Butyl Alcohol	111	232	T-2	430	806	A		
Iso Propane	83	181	T-2	400	752	A	B	A
Iso Propyl Acetate	89	192	T-2	460	860	A	A	A
Iso Propyl Alcohol	83	181	T-2	400	752	A		A
Iso Propyl Glycol	143	289	T-2	345	653	A		
Lacquer Solvents	140	284	T-2	535	995	A	A	A
Methyl Acetate	58	136	T-2	454	850	A	B	A
Methyl Cellosolve Acetate	156	313	T-2	377	711	A	B	A
Methyl Ethyl Ketone (M.E.K.)	80	176	T-1	530	986	A	A	A
Methyl Glycol Acetate	137-152	278-305	T-2	380	716	A	A	A
Methyl Isobutyl Ketone (M.I.B.K.)	117	243	T-1	459	858	A	B	A
N. Butyl	118	244	T-2	366	691	A		A
Pentanol	138	280	T-2	327	621	A		A
Propanol	98	208	T-2	371	700	A		A
Propyl Alcohol	98	208	T-2	371	700	A	A	A
Propyle Acetate	101	214	T-2	450	850	A	A	A
Paint Thinner	140	284	T-2	535	995	A	B	B
Sec. Butyl Alcohol	101	214	T-2	390	734	A		A
Toluol	110	231	T1	480	905	A	A	A

FLAMMABLE SOLVENTS
(vacuum system required)

SOLVENT TYPE	Distillation Temperature		Temperature Class	Ignition Temperature		Seal Teflon braided	Condenser Type	
	°C	°F		°C	°F		cop	s/st
Aliphatic hydrocarbons		370			487	A	A	A
Bottcherin		370			487	A	A	A
Citrus terpenes	176	349		237	458	A	A	A

FLAMMABLE SOLVENTS (CONT'D)

(vacuum system required)

SOLVENT TYPE	Distillation Temperature		Temperature Class	Ignition Temperature		Seal Teflon braided	Condenser Type	
	°C	°F		°C	°F		cop	s/st
D LIMONENE	176	349		237	458	A	A	A
DIMETHYLFORMAMIDE (DMF)	153	307	T-2	445	833	A	A	A
ETHER GLYCOL	210			277		A	A	A
LO NX (KODAK)	203	398		N/A	N/A	A	A	A
N-METHYLPYRROLIDONE	202	396		N/A	N/A	A	A	A
WHITE SPIRIT	150-175	302-374	T-2	353	489	A	A	A
VAR SOL	150	302	T-2	351	487	A	A	A
VIROSOL 225				N/A	N/A	A	A	A

NON - FLAMMABLE CHLORINATED SOLVENTS

(vacuum system required)

SOLVENT TYPE	Distillation Temperature		Temperature Class	Ignition Temperature		Seal Silicone	Condenser Type	
	°C	°F		°C	°F		cop	s/st
1,1,1. Trichloroethane-(Methyl Chloroform)	74	165				A		A
n-Propyl Chloride	47	117				A		A
Isopropyl chloride	40	104				A		A
Methylene chloride	40	106				A		A
Dichloroethylene	37	99				A		B
Ethylene dichloride	84	183				A		A
Monochlorobenzene	133	273				A		A
Propylene dichloride	98	208				A		A
Chloroform	61	142				A		A
Trichloroethylene	92	198				A		A
Trichloroethane	115	239				A		A
Ortho dichlorobenzene	182	361				A		A
1,2,3. trichloropropane	158	317				A		A
Carbon tetrachloride	78	172				A		A
Perchloroethylene	122	254				A		A
Tetrachloroethane	147	297				A		A



WARNING



The information and data set forth in this catalog or the information disclosed by a representative is for your general information only. Many factors influence the resistance of materials to corrosion, such as temperature, concentration, aeration and contaminants.

A – Recommended

B – Not Recommended

Blank – Information not available

THERMIC OIL CHANGING PROCEDURES

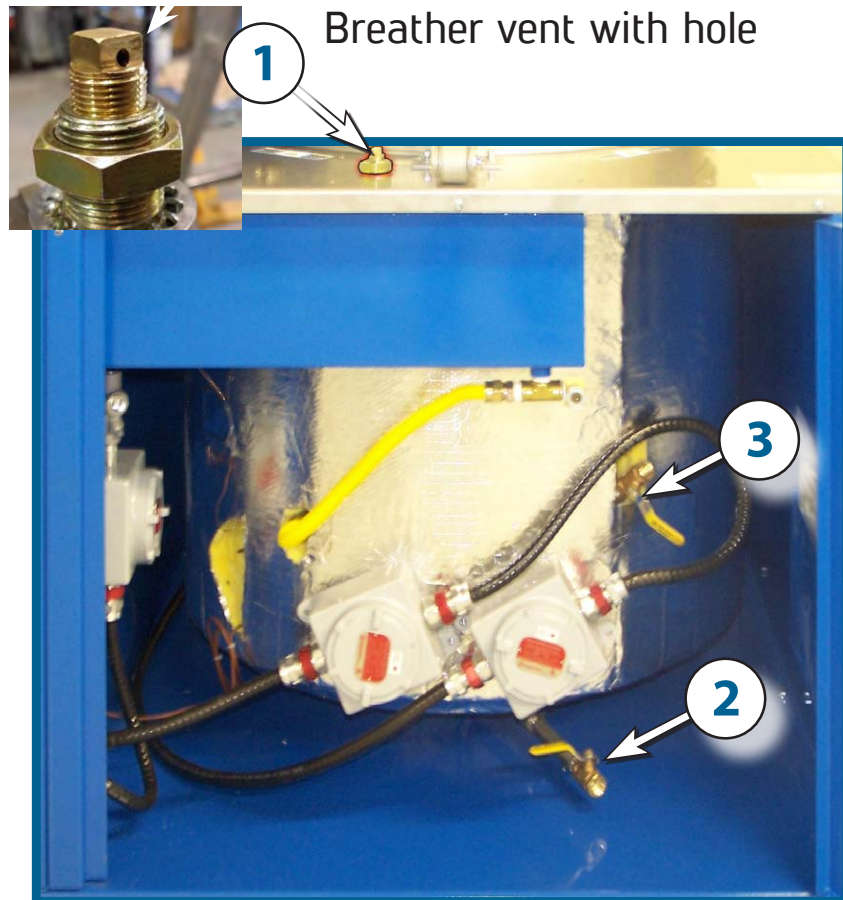

It is recommended to change the oil & the orange cover seal (304020) or 304025 (black) every 2000 hours of work or every year whichever comes first.

1. Remove the overflow valve # (1) and remove the plug on the ball valve # (2) & # (3) and open the breather valve # (3)
2. Place the empty oil collector container below the ball valve # (2) on open the valve to remove the used oil.
3. When empty, close the ball valve # (2), remove the container and re-install the plug on the ball valve # (2).
4. Install a funnel on (1) and pour new thermic oil into the funnel until full (the oil level must reach the porthole).
5. Close the ball valve (3) and re-install the vent tube plug on the ball valve (3) and the overflow valve special plug (1).

KEYBOARD ERROR CODES

There are **SIX (6) ERROR** codes that can be displayed if a problem occurs :

1. **O HI** code indicates that the **OIL** temperature is **too HIGH**.
2. **L HI** code indicates that the recycled **SOLVENT** temperature is **too HIGH**.
3. **S HI** code indicates that the recycled **SLUDGE** temperature is **too HIGH (OPTIONAL)**.
4. **P-OFF** : water pressure is **LOW** or vacuum negative pressure is **LOW**. (after 10 minutes).
5. **FILL - O** : **FILL NOT COMPLETED** after 20 minutes.
6. **PRS LO** : water pressure is **TOO LOW**.

The **ERROR** code can be erased by touching the + key (9) for each code. Once all the codes have been erased, the display returns to normal and the **ERROR** light disappears.

TROUBLESHOOTING

Distillation at Atmospheric Pressure

Defects	Causes	Remedies
Unit heats but does not distill	Boiler is dirty.	Clean the boiler.
	The solvent boiling point is higher than the temperature indicated on the control panel.	Set a higher temperature on the control panel.
	The solvent boiling temperature is higher than the recyclers highest temperature setting.	Use a solvent with a lower boiling temperature or vacuum distill with the suitable kit (optional).
	Thermic oil is worn out.	Change thermic oil.
	Lack of thermic oil.	Add thermic oil
Smoke comes out from the cover.	Polluting products overheating.	Reduce time and/or working temperature.
	Polluting products decomposing.	Possibly vacuum distill with the suitable kit.
	Dirt on cover gasket.	Clean cover gasket.
Cover gasket swells.	Cover is opened while recycler is hot.	Open the cover one hour after the cycle is complete
	The cover gasket is not suitable for the type of solvent to be distilled	Mount the suitable gasket (see page 19).

TROUBLESHOOTING (CONT'D)

Distillation at Atmospheric Pressure

Defects	Causes	Remedies
Solvent leaks from the gasket.	Worn out gasket.	Replace the gasket.
	Vapor manifold is clogged	Using a funnel, pour in clean solvent, wash vapor tube and blow air into the tube.
	Vapor condenser is clogged.	Replace the condenser.
Unit is in operation mode but does not heat. Indicator light is ON.	Temperature is set at zero.	Increase temperature.
	Burnt out heater.	Change the defective heater
	Mechanical thermostats is defective.	Change the faulty thermostat.
	Thermocouple sensor is defective	Change the faulty thermocouple
Distills only part of the dirty solvent.	Insufficient operating time selected.	Increase the operating time.
	The undistilled fraction has a boiling temperature higher than the temperature set on the control panel.	Set a higher temperature on the control panel.
	Solvent-boiling temperature is higher than the recycler's maximum working temperature.	Convert to a lower boiling solvent or use a vacuum operated unit.
Trouble light flashes and horn signals a problem	Distillate temperature is over 40°C	
	Ventilator motor burns out.	Replace the ventilator motor.
	Vapor condenser internally dirty	Clean by compressed air jet.
	Vapor condenser externally scaled.	Wash it, by pouring clean solvent with a funnel into the manifold
	The security thermostat is defective.	Replace the thermostat
Distillate comes out dirty	Loaded with a quantity superior to the maximum.	Load with the exact quantity.
	Solvent foams.	Wait at least 48 hours before beginning a new cycle
	Temperature set on control panel too high.	Reduce working temperature.
	Vapor manifold or condenser dirty.	Wash it by pouring clean solvent with a funnel into the manifold

TROUBLESHOOTING (CONT'D)

Distillation at Atmospheric Pressure

Defects	Causes	Remedies
Distillate assumes a greenish color.	Distilling solvents or reducers in general.	
	The solvent is acidic.	Replace copper condenser with a stainless steel condenser.
	Distilling a chlorinated solvent.	
	Condenser is becoming corroded.	Temperature set on the control panel is higher than the temperature indicated.
Solvent acidifies. If the temperature set on the control panel is correct, acidification occurred during process before distillation.		Replace the solvent immediately.
Distillation time is more than 4 hours.	There is a considerable percentage of water in the dirty solvent.	Replace the solvent.
	Lack of thermic oil.	Add thermic oil.
	Thermic oil is worn out.	Change thermic oil.
	Heater is scaled.	Remove thermic oil and clean the heater.
Distills only part of the dirty solvent.	Insufficient operating time selected.	Increase the operating time.
	The undistilled fraction has a boiling temperature higher than the temperature set on the control panel.	Set a higher temperature on the control panel.
	Solvent-boiling temperature is higher than the recycler's maximum working temperature.	Convert to a lower boiling solvent or use a vacuum operated unit.
Trouble light flashes and horn signals a problem	Distillate temperature is over 40 °C	
	Ventilator motor burns out.	Replace the ventilator motor.
	Vapor condenser internally dirty	Clean by compressed air jet.
	Vapor condenser externally scaled.	Wash it, by pouring clean solvent with a funnel into manifold
	The security thermostat is defective.	Replace the thermostat

TROUBLESHOOTING (END)

Distillation at Atmospheric Pressure

Defects	Causes	Remedies
No vacuum protection	Lack of compressed air.	Adjust the air pressure.
	Lack of compressed air circuit.	Check the connection.
	Distilling a chlorinated solvent.	Turn off the distillate-unloading tap.
	The rubber tube of connection to distillate container is not perfectly connected.	Check the connection towards the condenser and connection on rapid clutch.
	Rubber tube deteriorated.	Change the rubber tube.
	Lack of distillate level control.	Check the connections.
	The cover does not have a perfect seal.	Place the cover correctly on the shoulder of the boiler.
	Cover gasket deteriorated.	Replace the gasket.
	Solenoid defected.	Replace the solenoid.
	Vacuum pump damaged.	Change the vacuum pump.
During the distillation distillate comes out dirty.	Solvent foams.	Use anti-foaming discs, see page 28.
		Load less quantity of solvent.
		Reduce the working temperature.
		Reduce the compressed air feeding.
		Wait at least 48 hours before beginning a new cycle.
During drying distillate pigments.	Draws polluted products.	Separate the distillation phase than the drying ones. At the end of the distillation discharge the distillate tank and proceed to dry. At the end of drying wash the tank.

MAINTENANCE

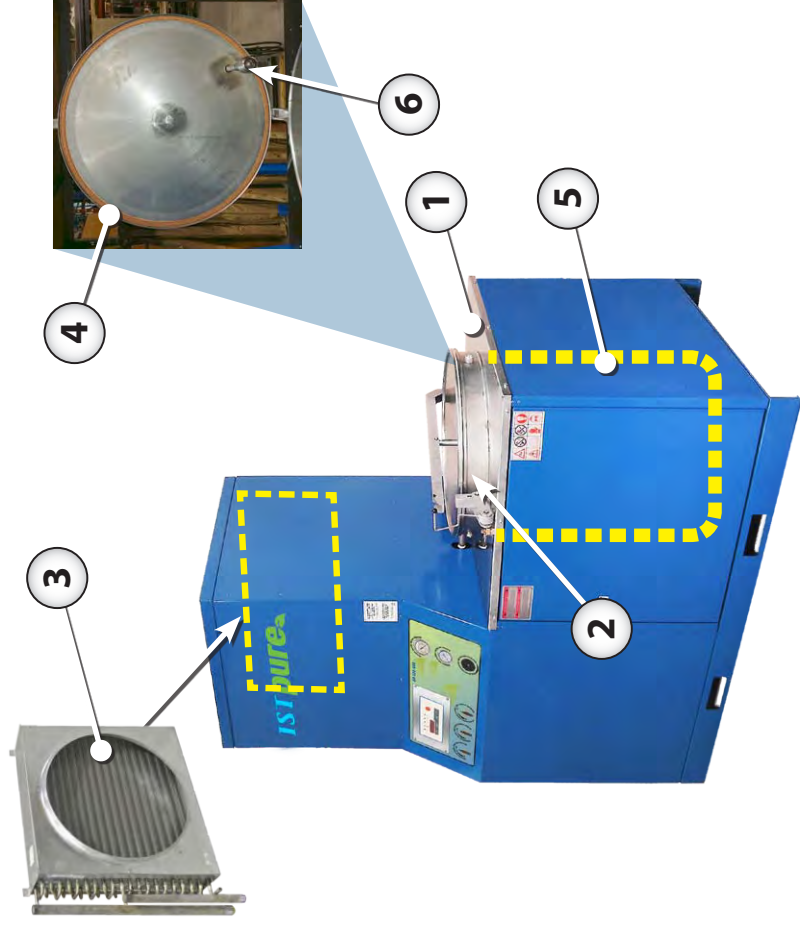

EVERY DAY

- Clean work surface **1**
- Clean boiler **2**

EVERY 2 000 HEURES OF OPERATION

- Change the cover seal **4** (see detail page 30)
- Change oil **5** (see procedure page 31)
- Cleaning the level sensor **6**

EVERY MONTH

- Clean the condenser **3** with an air blower

SPARE PARTS LIST

DESCRIPTION	PART NB
Cover Seal 4	See table under
Thermic Oil 5	
Seal Roller	NPN

Model	Oil Capacity	Parts Number 5		
SR30 TO SR240	Please refer to your product identification plate for required oil volume. 	Standard	High Temp.	Volume
		330066	330166	1 gal / 4L
		330067	330167	2.0 gal / 11L
		330068	330168	5 gal / 19L
		330069	330169	55 gal / 208 L

SR Model	Sealing gaskets 4
SR240/600V # 325230	ORANGE SEAL # 304020
SR240/480V #326230	
SR240V/600V #325231	BLACK SEAL # 304025
SR240V/480V #326231	

SCHEMATIC OF UNIT - FRONT VIEW

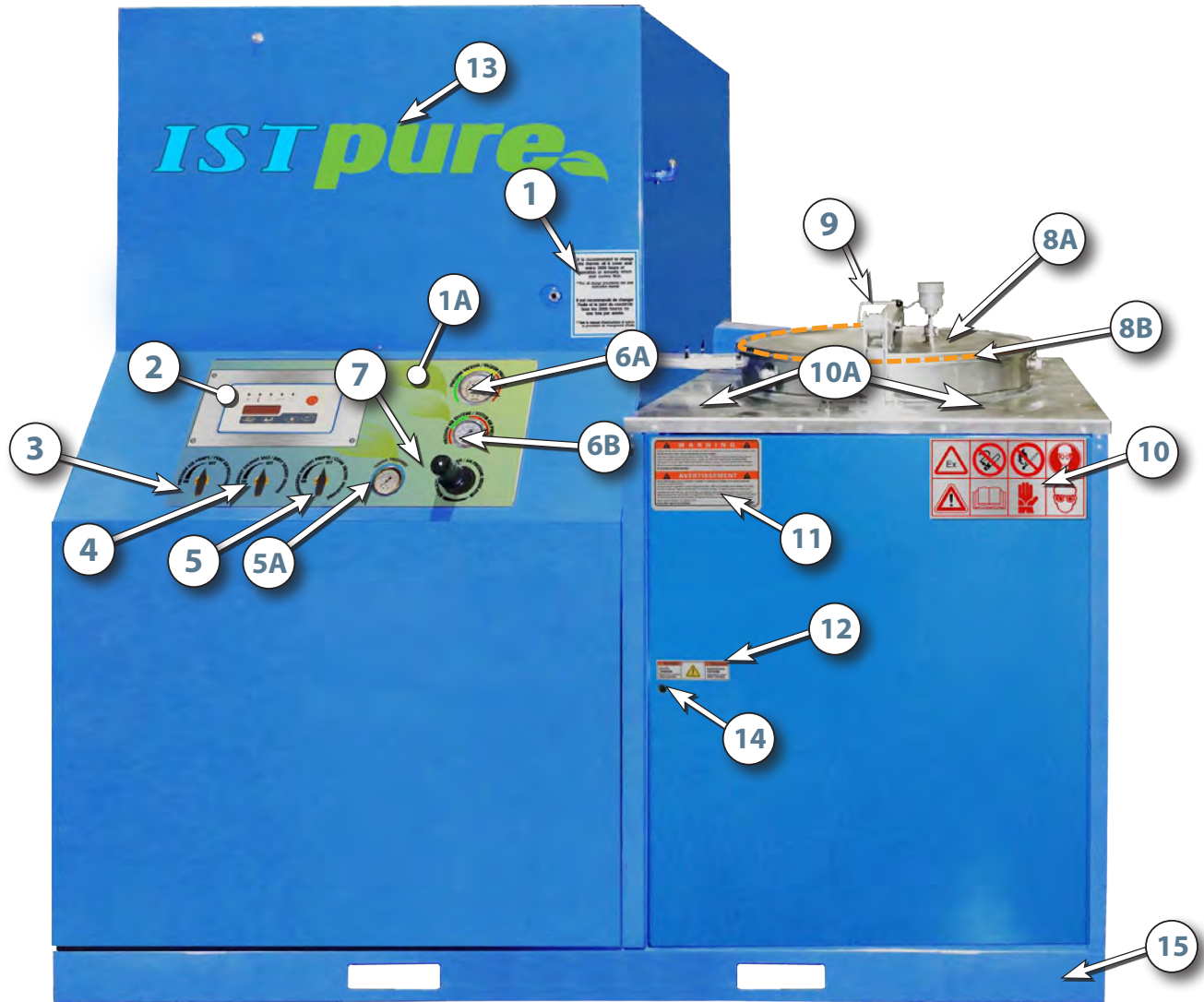

Nb	PART #	DESCRIPTION	Qty
1	331028	STICKER CHANGING OIL	1
1A	33105X	CONTROL PANEL STICKER	1
2	307003	FRONT KEY BOARD	1
3	324574	AIR CONTROL VALVE	1
4	324574	USED SOLVENT VALVE	1
5	324574	CLEAN SOLVENT VALVE	1
5A	911021	WATER PRESSURE GAUGE	1
6A	306003	VACUUM PRESSURE GAUGE	1
6B	611022	AIR PRESSURE GAUGE	1
7	608028	AIR REGULATOR	1

Nb	PART #	DESCRIPTION	Qty
8A	301022	COVER	1
8B	304020	COVER SEAL (ORANGE W/O VACUUM)	1
9	323726	2" ROUND HANDLE WITH ROD	1
10	331011	SAFETY STICKER	1
10A	331027	HOT SURFACE STICKER	1
11	331001	SAFETY STICKER	1
12	331034	HAZARDOUS VOLTAGE STICKER	1
13	331053	ISTPURE STICKER	1
14	323117	DOOR HANDLE	1
15	323075	LEVELERS	2

SCHEMATIC OF UNIT - SIDE VIEW

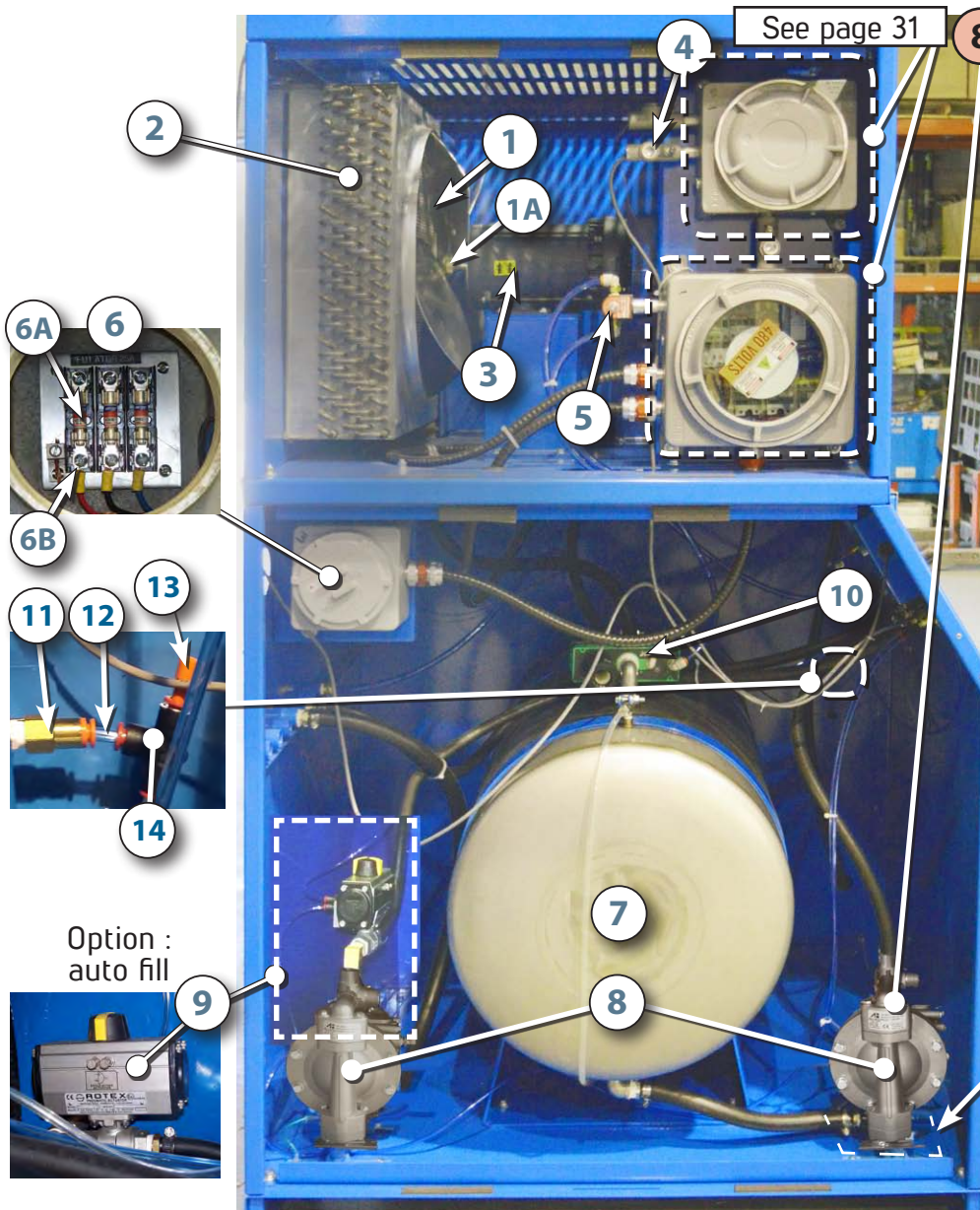

See page 31

8 If your unit was purchased prior to serial numbers below, it is running on a pump that has been replaced since.

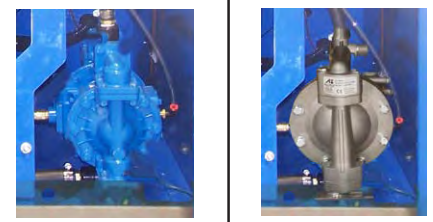

Old Pump	*New pump
324598	324596

First Units Manufactured with New Pump

Voltage	Model	Serial Nb.
380V	SR240	TI-99X3-_____

You will need a retrofit kit (includes the new pump).

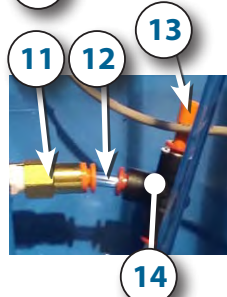
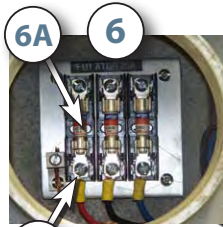

Nb	PART #	DESCRIPTION	Qty
1	303010	FAN BLADE	1
1A	303011	16 mm HUB	1
2	306016	COPPER CONDENSER	1
	306015	STAINLESS STEEL CONDENSER	1
3	303013	MOTOR 750W 400V/3Ph/50 Hz	1
4	322012	EYS CONNECTOR	1
5	324003	SOLENOID VALVE	1
6	322001	FUSES BOX	1
6A	-/-	AS PER ELECTRICAL DRAWING	3

Nb	PART #	DESCRIPTION	Qty
6B	917738	FUSE HOLDER	3
7	324115	VACUUM TANK	1
8	324596	CLEAN & USED SOLVENT PUMPS	2
8A	324592	NEW PUMP RETROFIT KIT	2
9	324532	VALVE ROTEX	1
10	314078	VACUUM GENERATOR	1
11	324573	6.35 mm PUSH-IN FEM.	1
12	NPN	SWITCH CABLE	1
13	324504	6.35 mm PUSH-IN PERFORATED PLUG	1
14	324584	6.35 mm "T" PUSH-IN FITTING	1

* Retrofit new pump : see details pages 42 to 59.

SCHEMATIC OF UNIT - OIL CHAMBER

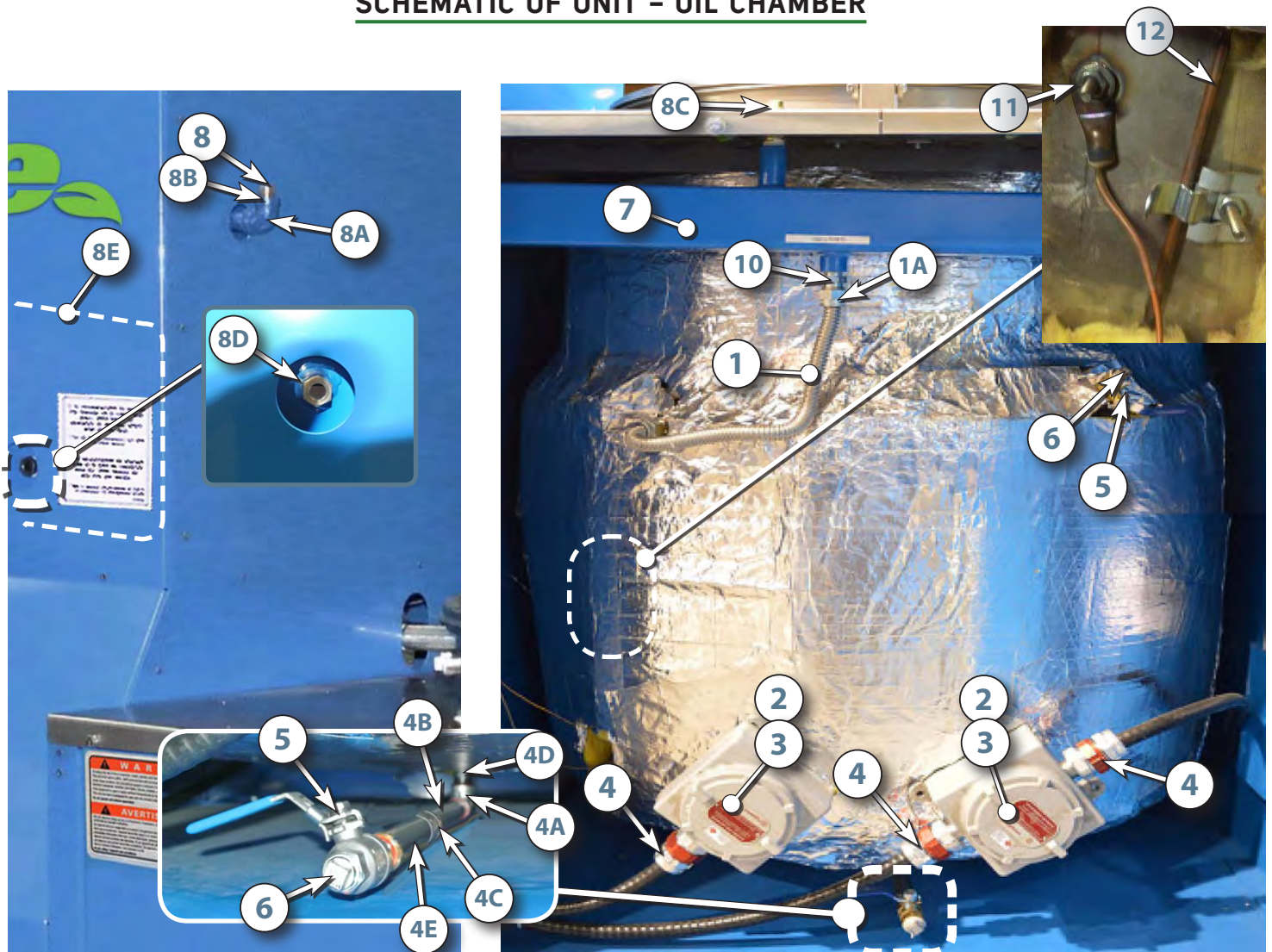

Nb	PART #	DESCRIPTION	Qty
1	323152	OIL FLEXIBLE TUBE	1
1A	323149	CONNECTOR	1
2	322002	EXPLOSION PROOF BOX	1
3	302005	HEATER 380V-6000W	1
4	322003	19.05 mm CABLE TECK CONNECTOR	5
4A	323533	90° ELBOW 12.7 mm FF	1
4B	323527	NIPPLE 203 mm x 12.7 mm	1
4C	323501	COUPLING 12.7 mm	1
4D	323525	NIPPLE 76 mm X 12.7 mm	1
4E	323526	NIPPLE 152 mm X 12.7 mm	1

Nb	PART #	DESCRIPTION	Qty
5	608102	BALL VALVE 12.7 mm	2
6	323522	PLUG 12.7 mm	1
7	NPN	OVERFLOW TANK	1
8	323063	BREATHER VALVE 9.5 mm	1
8A	630233	90° ELBOW 9.5 mm	1
8B	630206	89 mm x 9.5 mm NIPPLE	1
8C	323523	OVERFLOW TANK PLUG 9.5 mm	1
8D	310010	OIL LEVEL INDICATOR	1
8E	NPN	OIL TANK	1
10	632706	HEX NIPPLE 12.7 mm	1
11	307122	OIL TEMP. DETECTOR	1
12	308005	THERMOSTAT PROBE	1

SCHEMATIC OF UNIT - REAR VIEW



Nb	PART #	DESCRIPTION	Qty	Nb	PART #	DESCRIPTION	Qty
2	323086	GROUND CABLE WITH CLIP	1	5	NPN	STICKER " DANGER "	1
3	NPN	STICKER 380V	1	6	331059	STICKER OUTLETS ID	1
4	331024	STICKER VOLTAGE WARNING	1	7	NPN	OPTIONAL BARREL	1

SCHEMATIC OF UNIT – CONTROL BOARD

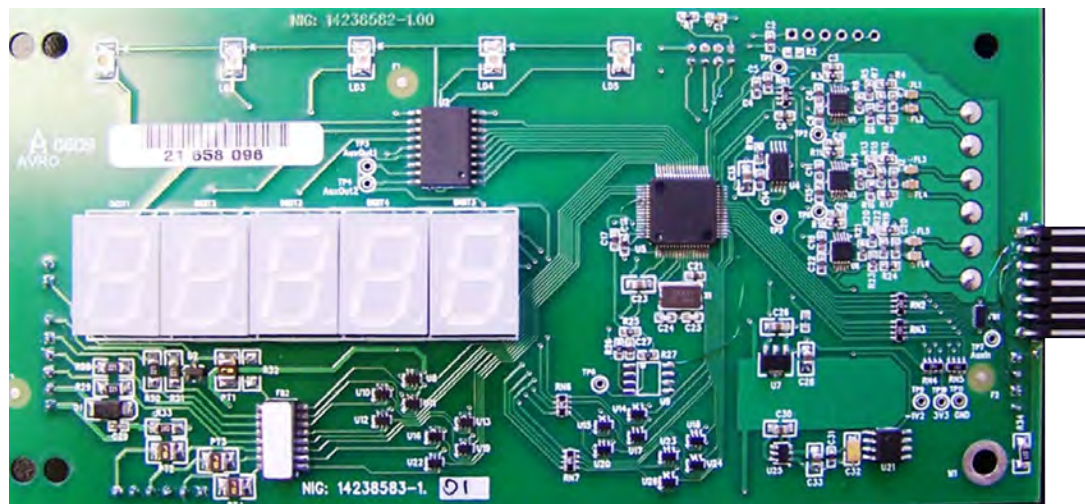
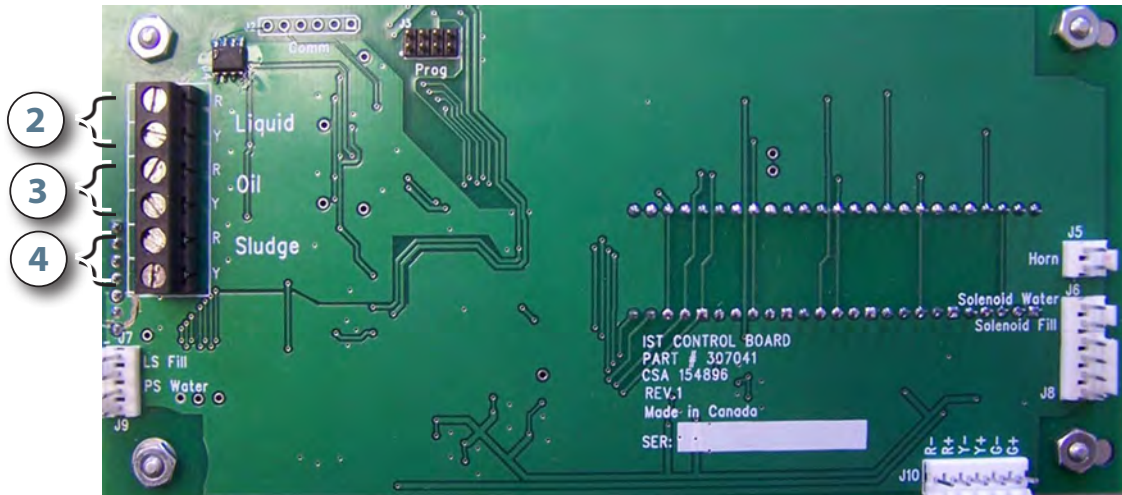

Nb	PART #	DESCRIPTION	Qty
1	307041	CONTROL BOARD	1
2	307123	TEMP. SENSOR FOR SOLVENT	1
3	307122	OIL HEAT SENSOR	1
4	321031	SLUDGE THERMOCOUPLE	1

SCHEMATIC OF UNIT - POWER SUPPLY KIT

(307040)

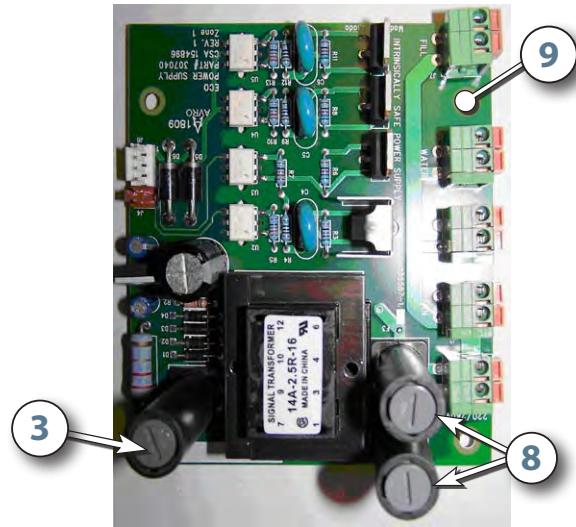
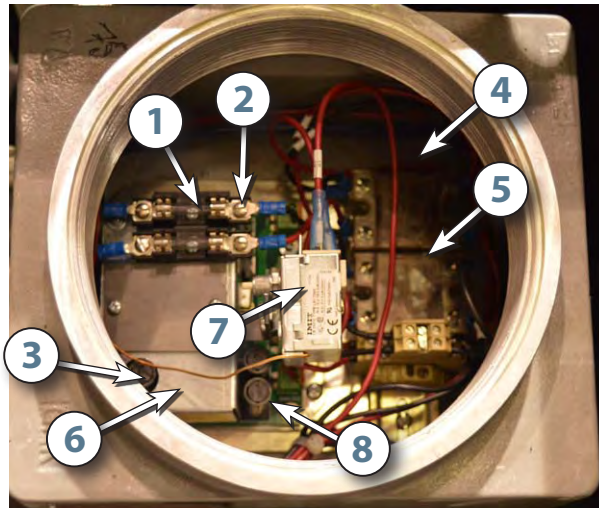

Nb	PART #	DESCRIPTION	Qty
1	307032	FUSE 0.5 A	2
2	307017	FUSE HOLDER	1
3	307131	FUSE 6.35 mm	1
4	303053	SOLID STATE RELAY	1
5	303053	SOLID STATE RELAY	1

Nb	PART #	DESCRIPTION	Qty
6	330009	INTRINSEC BARRIER	1
7	308010	HIGH LIMIT SWITCH	1
8	307130	FUSE	2
9	307040	POWER SUPPLY BOARD	1

SCHEMATIC OF UNIT - POWER SUPPLY TO LARGE EX. PROOF BOX

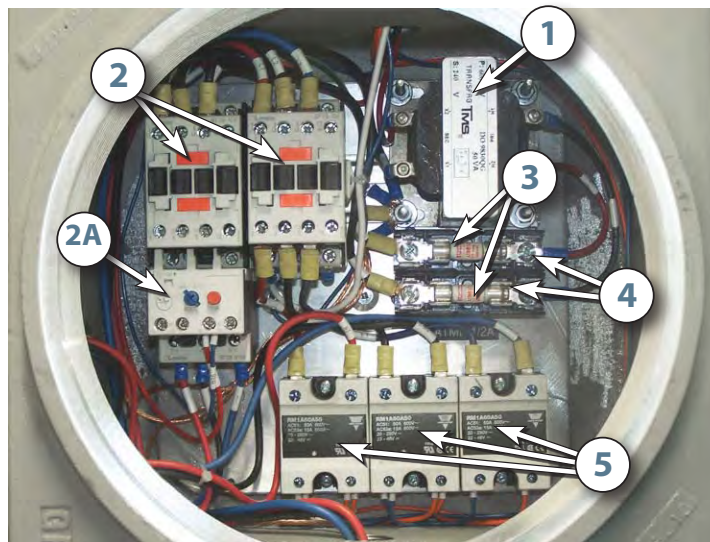

Nb	PART #	DESCRIPTION	Qty
1	314082	TRANSFO. 380/240V -1 Ph -50 Hz	1
2	314051	MOTOR CONTACTOR	2
2A	617066	MOTOR OVERLOAD 480V	1
	917730	MOTOR OVERLOAD 600V	1

Nb	PART #	DESCRIPTION	Qty
3	917726	FUSE 0.5 A	2
4	917738	FUSE HOLDER	2
5	314072	HEATERS SOLID STATE RELAYS	3

OPTIONAL EQUIPMENT SECTION

CRANE LIFTING DEVICE

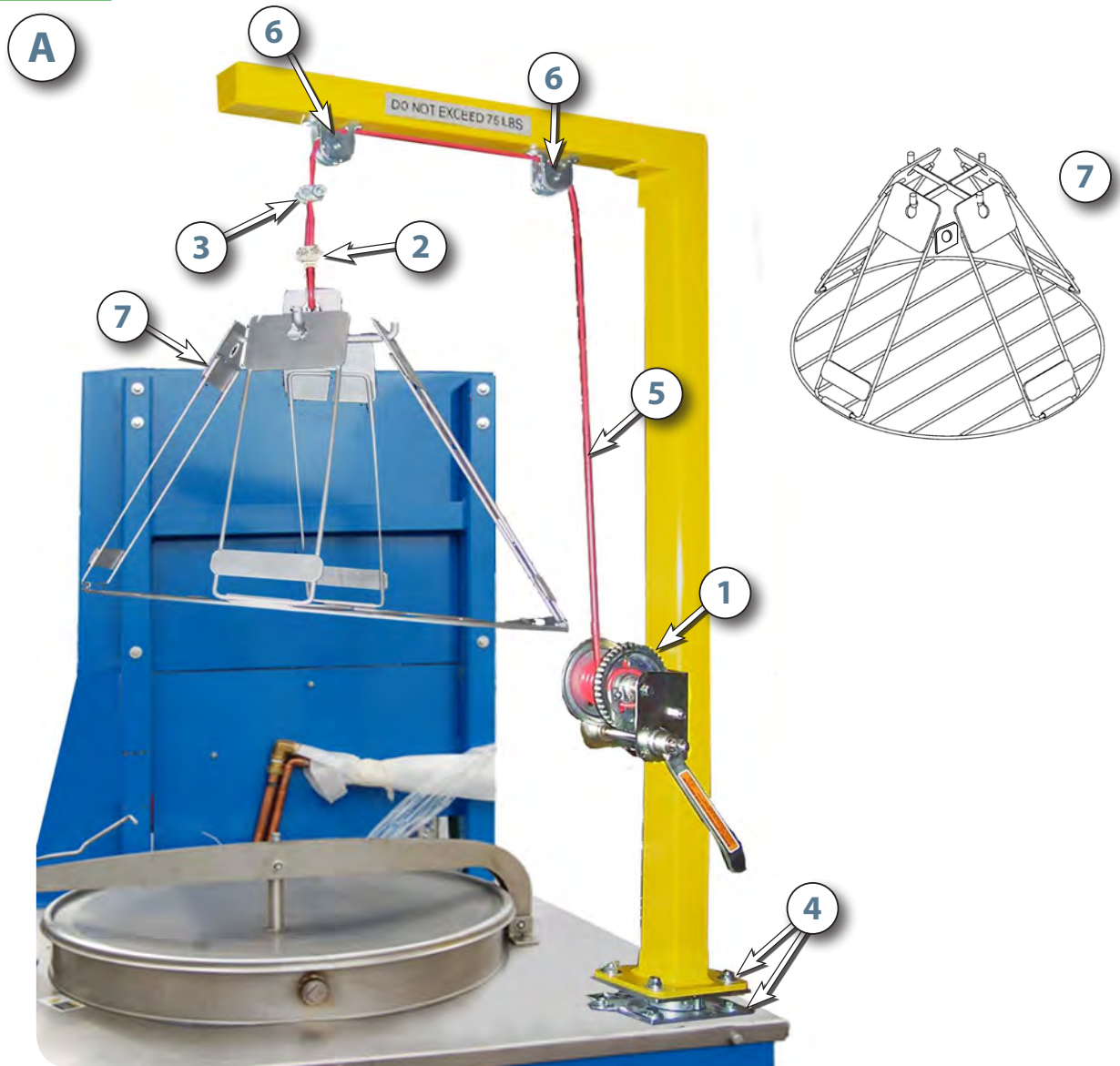

Nb	PART #	DESCRIPTION	Qty
A	320010	COMPLETE BAG LIFTING CRANE SYSTEM	1
1	301100	INCLINE-PULLING HAND WINCH WITH BRAKE EXPOSED GEAR	2
2	301102	COMBINATION WIRE ROPE CLAMP AND THIMBLE FOR 6.35 mm ROPE DIAM.	1
3	301103	DBL-SADDLE CROSBY FORGED STEEL WIRE ROPE CLIP ZINC-PLATED	1
4	301104	LOCKABLE HEAVY DUTY TURNTABLE 101.6 mm WIDTH X 152.4 mm LENGTH PLATE, 680 KG CAP.	1
5	301105	NYLON COATED WIRE ROPE	6.1m
6	301101	MOUNTED POLLEY	2
7	320055	HEAVY DUTY BAG RACK (OPTION)	1

OPTIONAL EQUIPMENT SECTION (CONT'D)

LOADING, UNLOADING & AUTO FILL UP

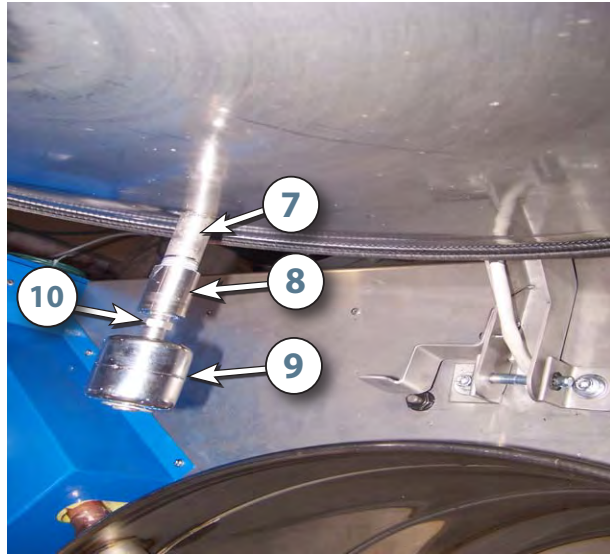
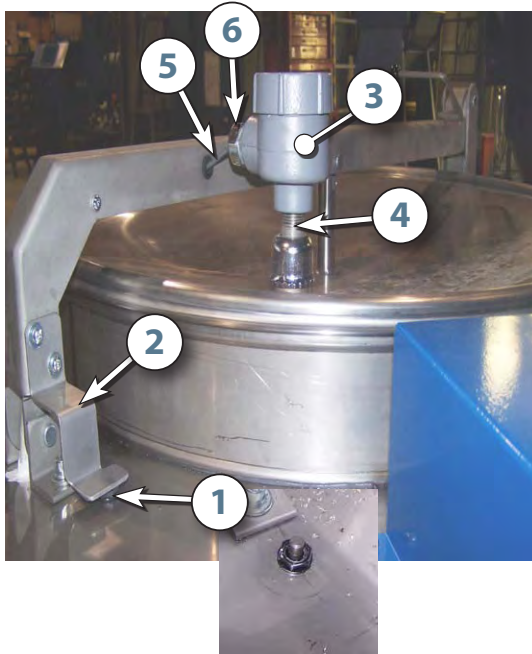

Nb	PART #	DESCRIPTION	Qty
1	324583	SWITCH FOR COVER	1
2	D323129S06	BRACKET	1
3	322006	JUNCTION BOX	1
4	323526	COUPLING	1
5	314066	COMMUNICATION CABLE	1
6	616735	CONNECTOR 2521	1
7	323527	NIPPLE	1
8	919812	REDUCING COUPLING	1
9	919810	LEVEL SWITCH	1
10	919811	COUPLING	1
11	324509	AUTOFILL VALVE	1

OPTIONAL EQUIPMENT SECTION (CONT'D)

OIL COOLING

1 - System case



NB : If you already have the nitro option your card have to be changed for : # 307043, and with the auto-fill option : # 307044

OPTIONAL EQUIPMENT SECTION (CONT'D)

OIL COOLING (CONT'D)

1 - System case and recycler rear view

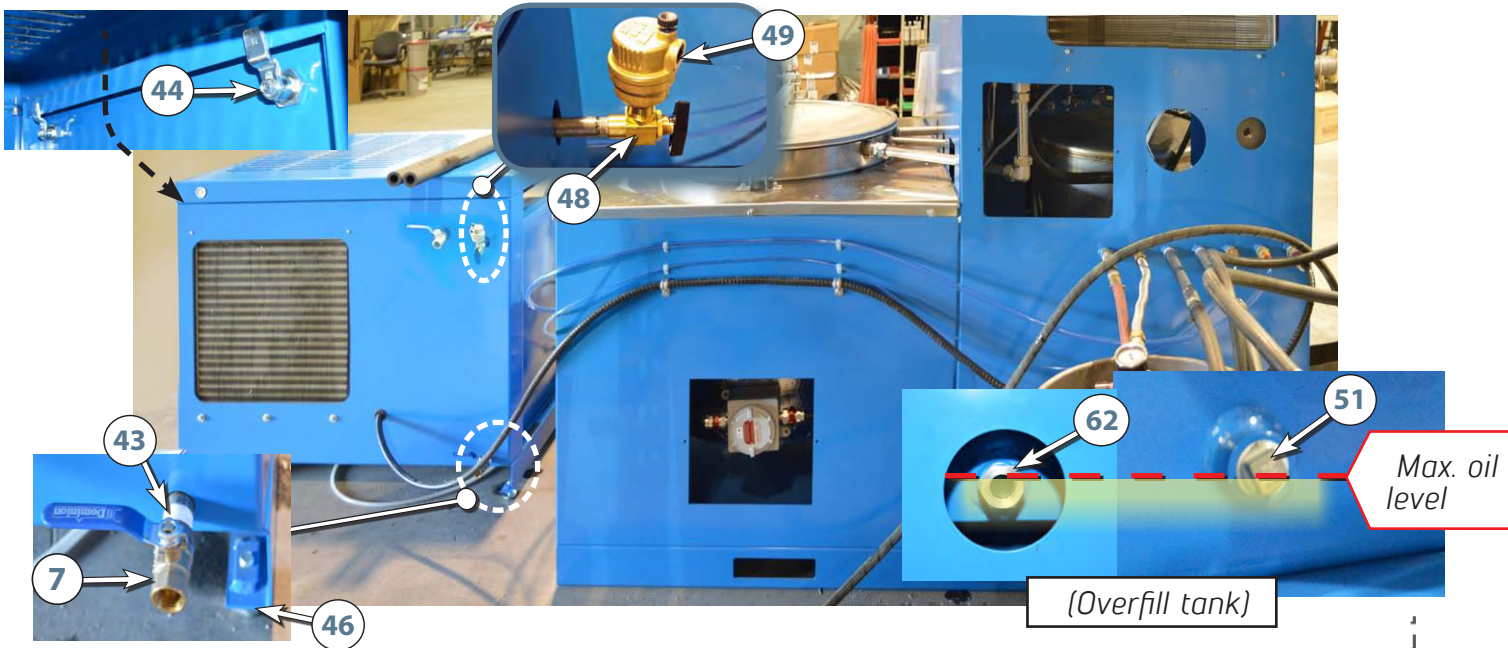

2 - Connections and additions to recycler

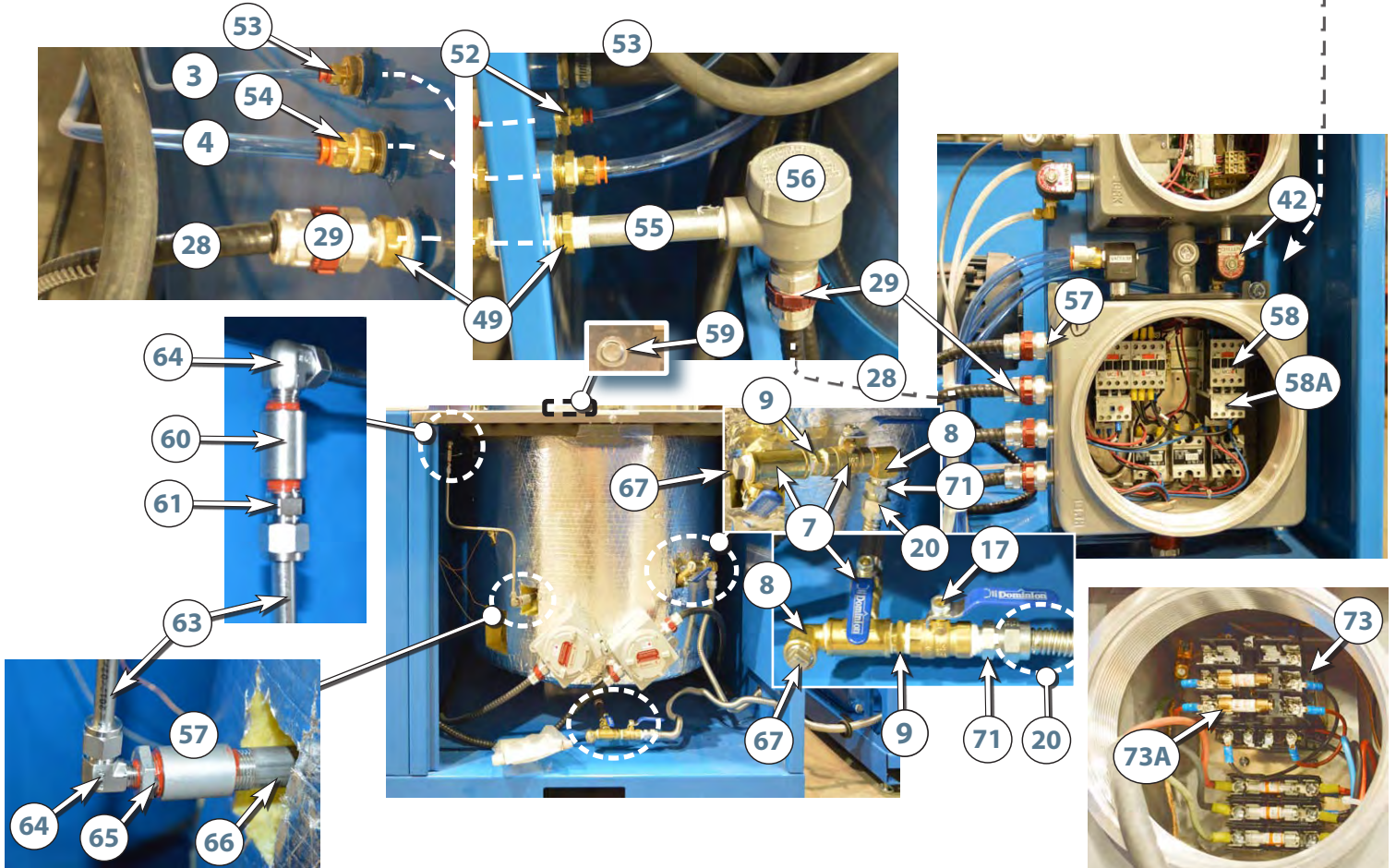

OPTIONAL EQUIPMENT SECTION (CONT'D)

OIL COOLING - PARTS LIST

#	STOCK	DESCRIPTION	#	STOCK	DESCRIPTION
1	314022	PUSH-IN 12.7 mm X 12.7 mm TUBE	31	305005	RADIATOR
2	324502	BUSHING UNION 6.35 mm	32	303012	MOTOR FAN
3	324570	POLYURETHANE HOSE 6.35 mm	32A	303011	HUB 16 mm
4	314025	POLYURETHANE HOSE 12.7 mm	33	324584	PUSH-IN TEE 6.35 mm TUBE
5	324573	PUSH-IN 6.35 X 6.35 mm TUBE	34	324570	PUSH-IN 3.2 mm - 6.35 mm TUBE
5A	324558	PUSH-IN 6.35 X 6.35 mm TUBE	35	324557	PUSH-IN "Y" 6.35 mm - 6.35 mm TUBE
6	632226	6.35 mm "T" STREET	36	323514	6.35 mm PLUG
6A	608409	ADAPTER FOR 608408	37	608534	PILOT VALVE
6B	608408	FLOW CONTROL	38	324527	MOTOR PUMP
7	608102	BALL VALVE 12.7 mm	39	324585	INSTALATING TUBE
8	632730	12.7 mm 90° ELBOW	41	632224	6.35 mm TEE
9	632706	12.7 mm HEX. NIPPLE	42	324003	SOLENOID VALVE
10	323525	12.7 mm NIPPLE x 76 mm	43	323525	NIPPLE 12.7 mm X 76 mm LG.
13	323535	REDUCER 19 mm TO 12.7 mm	44	924197	DOOR LATCH
14	632232	6.35 mm 90° ELBOW	46	323076	LEVELER
15	324509	6.35 mm X 6" NIPPLE	48	324522	2 WAYS VALVE
16	324509	12.7 mm ROTEX VALVE	49	932050	OIL BREATHER
17	324560	PUSH-IN 90° 6.35 mm X 6.35 mm TUBE	51	323522	12.7 mm PLUG
18	324539	MECHANICAL SEALS PUMP	52	323167	REDUCER 19 mm TO 6.35 mm
19	934140	19 mm 90° ELBOW FF	53	324558	PUSH-IN 6.35 mm - 6.35 mm TUBE
20	323153	GAS CONNECTOR 12.7 mm X 1220 mm	54	314022	PUSH-IN 12.7 mm - 12.7 mm TUBE
21A	632971	REDUCER 19 mm TO 12.7 mm	55	321041	ELECTRIC NIPPLE
22	323164	COMP. FITTING 12.7 mm X 16 mm TUBE	56	322006	JUNCTION BOX
23	NPN	12.7 mm FITTING	57	324528	SHAFT COUPLING
24	323192	19 mm 90° ELBOW	58	314051	CONTACTOR
25	324519	PUMP BRACKET	58A	917730	OVERLOAD
26	314058	PUSH-IN 90° 6.35 mm X 12.7 mm TUBE	59	NPN	CAP
	934029	OILER	60	323503	6.35 mm UNION
26B	323508	NIPPLE 6.35 mm X 76 mm lg.	61	323238	COMP. S.S. FITTING 6.35 mm - 9.5 mm TUBE
26C	323555	6.35 mm 90° ELBOW	62	308008	PORT HOLE
	934030	OIL FOR PUMP	63	321039	9.5 mm S.S. TUBE
27	618133	GROMMET	64	323209	90° COMP. FITTING 6.35 mm - 9.5 mm TUBE
28	916602	TECK CABLE 14-3 (gauge)	65	323206	REDUCER S/S 12.7 mm X 6.35 mm
29	322004	TECK CONNECTOR 12.7 mm	66	323525	NIPPLE 12.7 mm X 76 mm
30	303021	746 W / 460 V MOTOR			

OPTIONAL EQUIPMENT SECTION (CONT'D)

OIL COOLING (CONT'D)

3 - Oil filling procedure

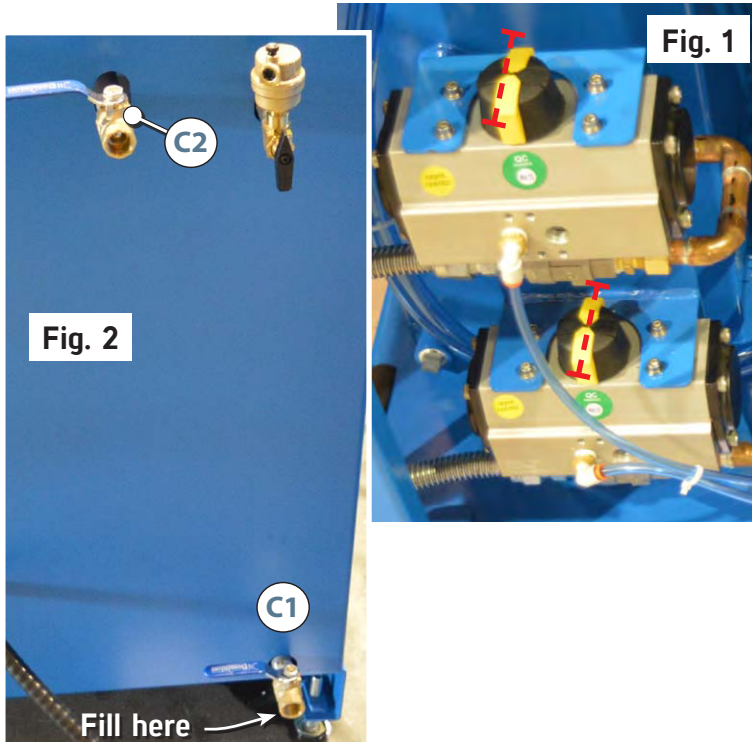

Before you begin, ensure the 2 Rotex valves (Fig. 1) are closed.

1. Start filling the tank by connecting to the ball-valve C1 (Fig. 2) of the oil cooling
2. Fill until to see oil get out of the ball valve C 2 (Fig. 2) of the oil cooling
3. Remove your oil supply hose and connect it to the ball-valve of the boiler (Fig. 5)
4. Fill to see oil go up the expansion tank control window --- (Fig. 6) (Use a flashlight if necessary to see correctly the oil level).
5. Unscrew the 6.35 mm plug located on the side of the expansion tank (Fig. 7) and continue to fill until you see the oil flow spill out of it : stop filling and rescrew the plug in place.

Remove the plug, and connect here.(the 2 boiler ball-valves must be in open position, but the 2 cooling tank ball valve must be closed to avoid over filling it)

Your filling process is now completed.

NB : ensure that the oiler pump is always filled with pneumatic oil by checking the level (Fig. 8)

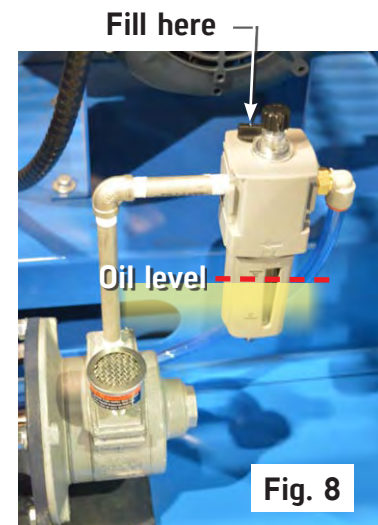
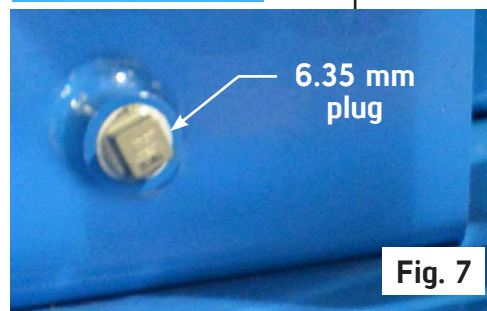
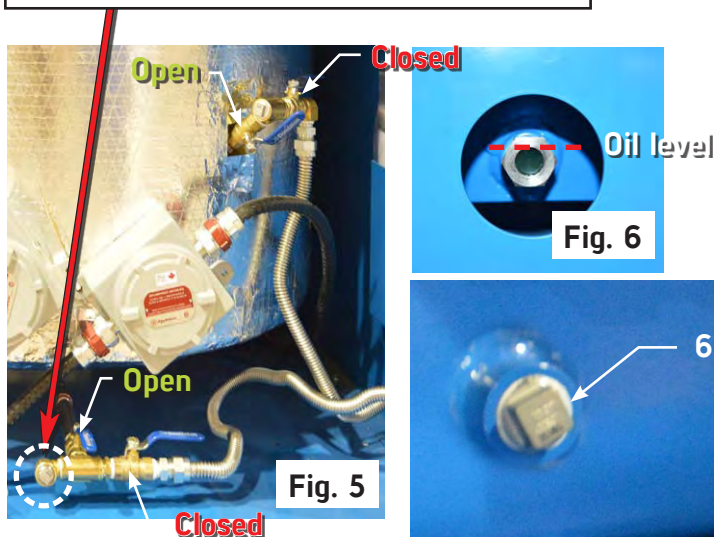

OPTIONAL EQUIPMENT SECTION (END)

ELECTRICAL LIGHTS BOX

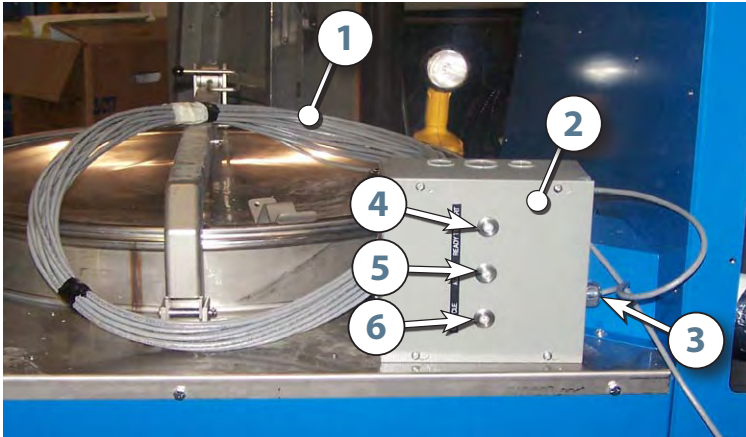

Nb	PART #	DESCRIPTION	Qty
1	314066	COMMUNICATION CABLE	3.05 m
2	314065	ELECTRICAL BOX	1
3	616740	CONNECTOR 2521	1
4	314063	GREEN LIGHT	1
5	314062	RED LIGHT	1
6	314064	YELLOW LIGHT	1

SLUDGE MONITORING SAFETY DEVICE

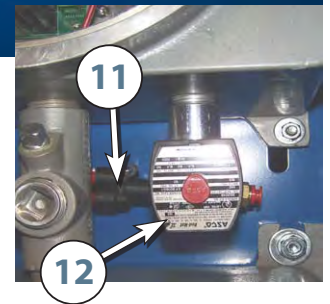
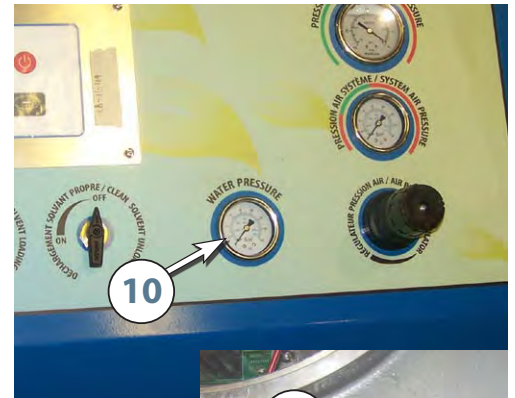
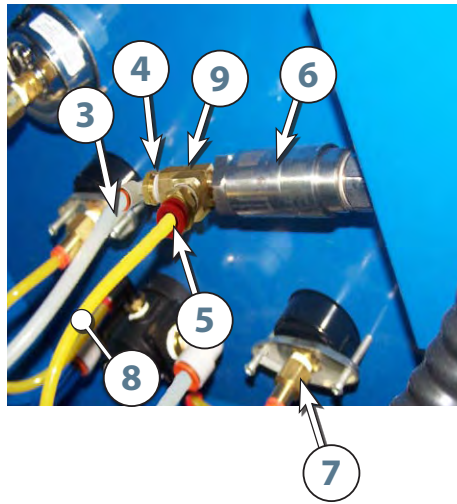
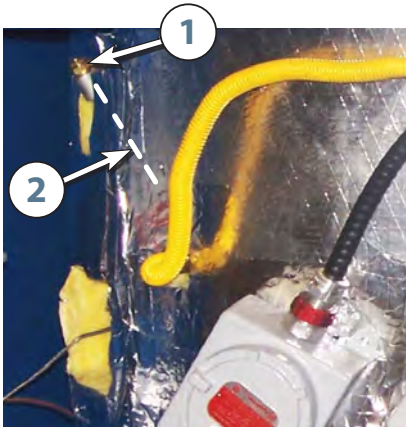

Nb	PART #	DESCRIPTION	Qty	Nb	PART #	DESCRIPTION	Qty
1	323225	CONNECTOR FOR SENSOR	1	7	324573	PUSH IN 6.35 mm F	1
2	321031	SENSOR FOR SLUDGE	1	8	324511	URETHANE HOSE	1
3	324512	CLEAR HOSE	6	9	632226	STREET TEE 6.35 mm	1
4	323130	CONNECTOR	2	10	911021	UNDER PRESSURE GAUGE	1
5	324558	PUSH IN 6.35 mm	2	11	324557	PUSH IN 6.35 mm "Y"	1
6	314068	PRESSURE SWITCH	1	12	3240030	SOLENOID VALVE	1

DOUBLE DIAPHRAGM PUMP MODEL A050 M 12.7 mm

CAUTIONS & WARNINGS

READ THESE WARNINGS AND SAFETY PRECAUTIONS PRIOR TO INSTALLATION OR OPERATION. FAILURE TO COMPLY WITH THESE INSTRUCTIONS COULD RESULT IN PERSONAL INJURY AND OR PROPERTY DAMAGE. RETAIN THESE INSTRUCTIONS FOR FUTURE REFERENCE.

WARNING This product can expose you to chemicals including Nickel, Chromium, Cadmium, or Cobalt, which are known to the State of California to cause cancer and/or birth defects or other reproductive harm. For more information, go to www.P65Warnings.ca.gov.

WARNING Pump, valves and all containers must be properly grounded prior to handling flammable fluids and/or whenever static electricity is a hazard.

WARNING Prior to servicing the pump, ensure that the air and fluid lines are closed and disconnected. While wearing personal protective equipment, flush, drain and process liquid from the pump in a safe manner.

WARNING The TX marking refers to the maximum surface temperature depending not on the equipment itself, but mainly on operating conditions. In this case, the maximum surface temperature depends upon the temperature of the process fluids.

CAUTION The temperature of the process fluid and air input must be no more than 36°F (20C) less of the maximum temperature allowed for the appropriate non-metallic material. See the list of temperatures below for each material's maximum recommended temperature:

Buna-N (Nitrile):	10°F to 180°F (-12C to 82C)
Geolast®:	10°F to 180°F (-12C to 82C)
EPDM:	-40°F to 280°F (-40C to 138C)
Santoprene®:	-40°F to 225°F (-40C to 107C)
Viton® (FKM):	-40°F to 350°F (-40C to 177C)
PTFE:	40°F to 220°F (4C to 104C)
Polyethylene:	32°F to 158°F (0C to 70C)
Polypropylene:	32°F to 180°F (0C to 82C)
PVDF:	0°F to 250°F (-18C to 121C)
Nylon:	0°F to 200°F (-18C to 93C)

Temperature limits are solely based upon mechanical stress and certain chemicals will reduce the maximum operating temperature. The allowable temperature range for the process fluid is determined by the materials in contact with the fluid being pumped. Consult a chemical resistance guide for chemical compatibility and a more precise safe temperature limit. Always use minimum air pressure when pumping at elevated temperatures.

WARNING = Hazards or unsafe practices which could result in severe personal injury, death or substantial property damage

CAUTION = Hazards or unsafe practices which could result in minor personal injury, product or property damage.

CAUTION Do not lubricate air supply.

CAUTION Do not connect a compressed air source to the exhaust port of the pump.

WARNING Use only with liquid process fluid.

WARNING Maintenance must not be performed when a hazardous atmosphere is present.

CAUTION Do not exceed 120 psig (8.3 bar) air-inlet pressure.

CAUTION Do not exceed 10 psig (0.7 bar) or 23 ft-H₂O suction pressure.

CAUTION Ensure all wetted components are chemically compatible with the process fluid and the cleaning fluid.

CAUTION Ensure pump is thoroughly cleaned and flushed prior to installation into a process line.

CAUTION Always wear Personal Protective Equipment (PPE) when operating pump.

CAUTION Close and disconnect all compressed air and bleed all air from the pump prior to service. Remove all process fluid in a safe manner prior to service.

CAUTION Blow out all compressed air lines in order to remove any debris, prior to pump installation. Ensure that the muffler is properly installed prior to pump operation.

CAUTION Ensure air exhaust is piped to atmosphere prior to a submerged installation.

CAUTION Ensure all hardware is set to correct torque values prior to operation.

DOUBLE DIAPHRAGM PUMP MODEL A050 M 12.7 MM MODEL DESIGNATION MATRIX & REPAIR KITS-BOLTED PLASTIC

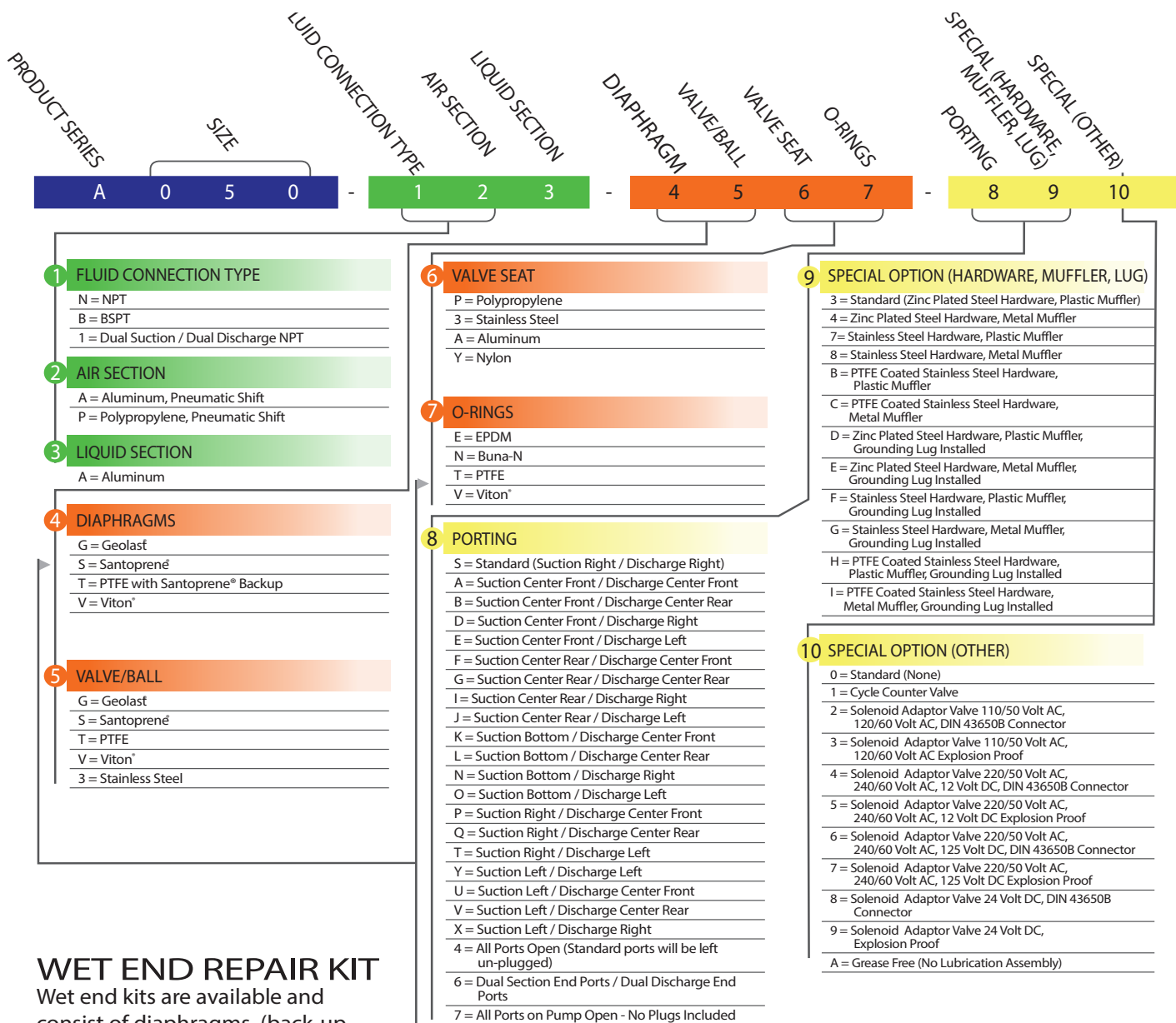

WET END REPAIR KIT

Wet end kits are available and consist of diaphragms, (back-up diaphragms if required), balls, seats and seat O-rings. See matrix below.

AIR END REPAIR KIT

Air end repair kit contains pilot sleeve assembly and main air valve.

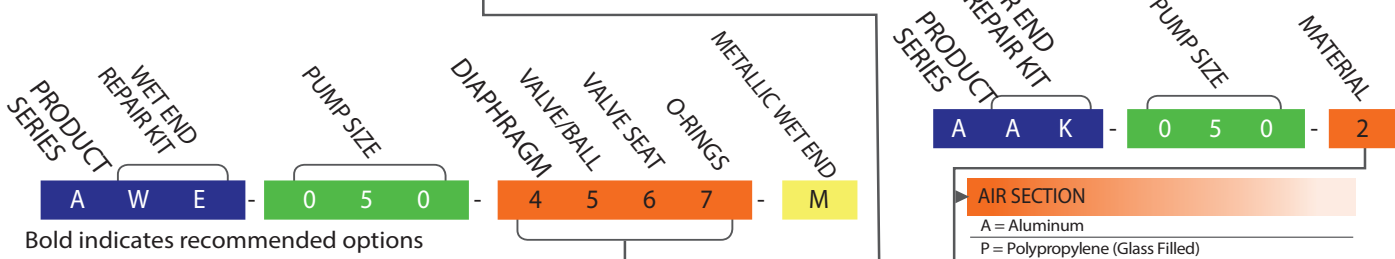

Bold indicates recommended options

* Solenoid Adaptor Valves only available on select pump models with polypropylene intermediate

DOUBLE DIAPHRAGM PUMP MODEL A050 M 12.7 MM

PRINCIPLES OF OPERATION

HOW AN AIR OPERATED DOUBLE DIAPHRAGM PUMP WORKS

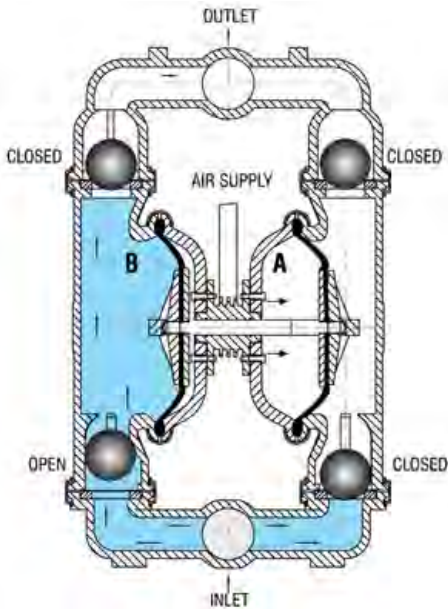

The air-valve directs pressurized air behind the diaphragm on the right, causing the diaphragm on the right to move outward (to the right).

Since both the right diaphragm and the left diaphragm are connected via a diaphragm rod, when the right diaphragm moves to the right, the left diaphragm (through the action of the diaphragm rod) moves to the right also.

When the diaphragm on the left side is moving to the right, it is referred to as suction stroke. When the left diaphragm is in its suction stroke, the left suction ball moves upward (opens) and the left discharge ball moves downward (closes). This action creates suction and draws liquid into the left side chamber.

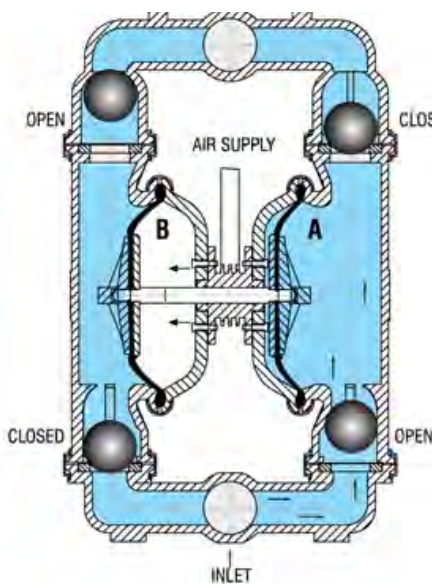

The air-valve directs pressurized air behind the left diaphragm, causing the left diaphragm to move outward (to the left).

Since both the left diaphragm and the right diaphragm are connected via a diaphragm rod, when the left diaphragm moves to the left, the right diaphragm (through the action of the diaphragm rod) moves to the left also.

When the diaphragm on the left side moves outward, the left discharge ball moves upward (opens) and the left suction ball moves downward (closes). This causes the liquid to leave the left side liquid outlet of the pump.

Simultaneously, the right diaphragm moves inward (to the left), which causes the right suction ball to open and the right discharge to close, which in turn causes suction, drawing liquid into the right chamber.

The process of alternating right suction / left discharge (and vice-versa) continues as long as compressed air is supplied to the pump.

DOUBLE DIAPHRAGM PUMP MODEL A050 M 12.7 MM
1/2" PUMP DIMENSIONS

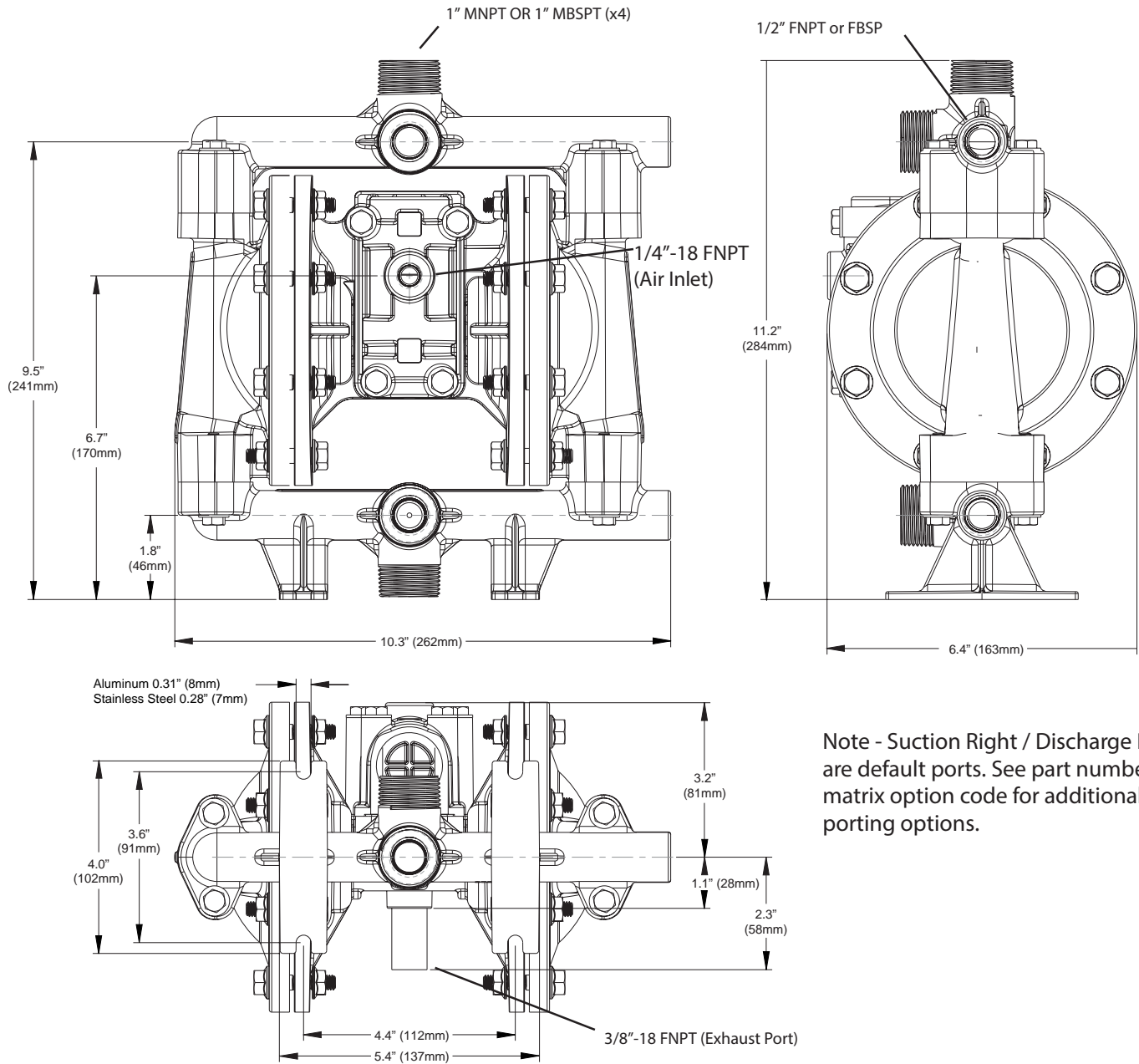

Note - Suction Right / Discharge Right are default ports. See part number matrix option code for additional porting options.

DOUBLE DIAPHRAGM PUMP MODEL A050 M 12.7 MM

INSTALLATION

PIPING

Whenever possible ensure the pump is installed using the shortest possible pipe lengths with the minimum amount of pipe fittings. Ensure all piping is supported independent of the pump.

Suction and discharge piping should not be smaller than the connection size of the pump. When pumping liquids of high viscosity, larger piping may be used, in order to reduce frictional pipe loss.

Employ flexible hoses in order to eliminate the vibration caused by the pump. Mounting feet can also be used to reduce vibration effects.

All hoses should be reinforced, non-collapsible and be capable of high vacuum service. Ensure that all piping and hoses are chemically compatible with the process and cleaning fluid.

For processes where pulsation effects should be reduced, employ a pulsation dampener on the discharge side of the pump.

For self-priming applications, ensure all connections are airtight and the application is within the pumps dry-lift capability. Refer to product specifications for further details.

For flooded suction applications, install a gate valve on the suction piping in order to facilitate service.

For unattended flooded suction operation, it is recommended to pipe the exhaust air above the liquid source. In the event of a diaphragm failure this will reduce or eliminate the possibility of liquid discharging through the exhaust onto the ground.

LOCATION

Ensure that the pump is installed in an accessible location, in order to facilitate future service and maintenance.

AIR

Ensure that the air supply is sufficient for the volume of air required by the pump. Refer to product specifications for further details. For reliable operation, install a 5 micron air filter, air-valve and pressure regulator. Do not exceed the pumps maximum operating pressure of 120 psig.

REMOTE OPERATION

Utilize a three way solenoid valve for remote operation. This ensures that air between the solenoid and the pump is allowed to "bleed off," ensuring reliable operation. Liquid transfer volume is estimated by multiplying displacement per stroke times the number of strokes per minute.

NOISE

Correct installation of the muffler reduces sound levels. Refer to product specifications for further details.

SUBMERGED OPERATION

For submersible operation, pipe the air exhaust to atmosphere.

GROUNDING THE PUMP

Loosen grounding screw and install a grounding wire. Tighten grounding screw. Wire size should be a 12 gauge wire or larger. Connect the other end of the wire to a true earth ground. Equipment must be grounded to achieve ATEX rating and it is recommended to configure the pump with a grounding lug option.



DOUBLE DIAPHRAGM PUMP MODEL A050 M 12.7 MM

TROUBLESHOOTING

PROBLEM	EFFECT/SOLUTION
Pump Will Not Cycle	<ul style="list-style-type: none"> Discharge line closed or plugged Discharge filter blocked Check valve stuck Air filter blocked Air supply valve closed Air supply hooked up to muffler side of pump Compressor not producing air or turned off Muffler iced or blinded Diaphragm ruptured Plant air supply line ruptured Air valve wear/debris Pilot sleeve wear/debris Diaphragm rod broken Diaphragm plate loose
Pumped Fluid Coming Out of Muffler	<ul style="list-style-type: none"> Diaphragm ruptured Diaphragm plate loose Inlet liquid pressure excessive (above 10 psig)
Pump Cycles but no Flow	<ul style="list-style-type: none"> Inlet strainer clogged Suction valve closed Suction line plugged No liquid in the suction tank Suction lift excessive Debris stuck in valves Excessive wear of check valves Air leak on suction side with suction lift
Pump Cycles with Closed Discharge Valve	<ul style="list-style-type: none"> Debris stuck in check valve Excessive wear of check valves
Pump Running Slowly/Not Steady	<ul style="list-style-type: none"> Air compressor undersized Leak in air supply Air-line, filter regulator or needle valve undersized Muffler partially iced or blinded Air valve gasket leak or misalignment Air valve wear/debris Pilot sleeve wear/debris Liquid fluid filter blocked Pump may be cavitating, reduce speed of operation Suction strainer clogged
Pump Will Not Prime	<ul style="list-style-type: none"> Air leak in suction pipe Air leak in pump manifold connections Suction strainer and lines clogged Excessive lift conditions Check valve wear Debris in check valve

DOUBLE DIAPHRAGM PUMP MODEL A050 M 12.7 MM

OPERATIO & MAINTENANCE

OPERATION

The Air-Operated Double Diaphragm Pump requires a minimum of 20 psig of air to operate, with some variation according to diaphragm material. Increasing the air pressure results in a more rapid cycling of the pump and thus a higher liquid flow rate. In order to not exceed 120 psig of inlet air pressure, and for accurate control of the pump, it is suggested to use a pressure regulator on the air inlet.

An alternate means of controlling the flow-rate of the pump is to use an inlet air valve and partially open or close accordingly. When the air valve is completely in the closed position, the pump will cease to operate.

A third method of controlling the flow rate of the pump is to use a liquid discharge valve. Closing the liquid discharge valve will cause a decrease in the flow rate since the pump will operate against a higher discharge pressure.

Solenoid control of the inlet air may also be used in order to facilitate remote operation. A three way solenoid valve is recommended, in order to allow the air to “bleed off” between the solenoid and the pump.

Do not use valves for flow control on the suction side of the pump. (Closing or partially closing a liquid suction valve restrict the suction line and may cause damage to the diaphragms.) Suction strainers may be employed to reduce or eliminate larger solids, but routine maintenance is necessary in order to prevent a restriction on the suction.

MAINTENANCE

Due to the unique nature of each application, periodic inspection of the pump is the best method to determine a proper maintenance schedule. A record should be kept of all repairs made to an installed pump. This will serve as the best predictor of future maintenance.

Typical maintenance involves replacing of “wear-parts” such as the diaphragms, balls, valve seats and O-rings. Proper maintenance can ensure trouble-free operation of the pump. Refer to repair and assembly instructions for further details.

 **WARNING** Maintenance must not be performed when a hazardous atmosphere is present.

MAINTENANCE SCHEDULE

WEEKLY (OR DAILY)

Make a visual check of the pump. If pumped fluid is leaking out of the pump, pipe fittings or muffler turn off pump and schedule maintenance.

EVERY THREE MONTHS

Inspect fasteners and tighten any loose fasteners to recommended torque settings.

Schedule pump service based on pump’s service history.

DOUBLE DIAPHRAGM PUMP MODEL A050 M 12.7 MM

REPAIR AND ASSEMBLY : PUMP WET END REMOVAL

TOOLS NEEDED

- 1) One Wrench, $\frac{7}{16}$ Inch
- 2) Two Wrenches, $\frac{1}{2}$ Inch
- 3) Two Wrenches, $\frac{3}{4}$ Inch
- 4) One Screwdriver, Slotted Head

! WARNING Prior to servicing the pump, ensure that the air and fluid lines are closed and disconnected. While wearing personal protective equipment, flush, drain and process liquid from the pump in a safe manner.

! WARNING Maintenance must not be performed when a hazardous atmosphere is present.

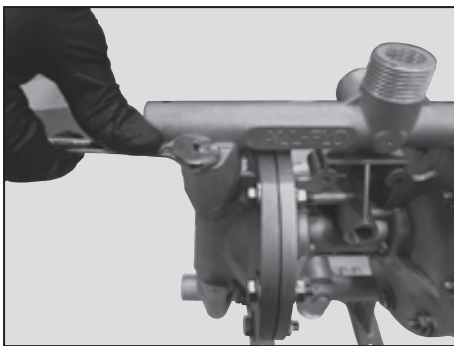

STEP 1

Using the $\frac{7}{16}$ inch wrench remove four "Hex-Head Cap Screws ($\frac{1}{4}$ "-20 x 1- $\frac{3}{4}$ ")" and four "Flat Washers ($\frac{1}{4}$ ")" from the "Discharge Manifold"

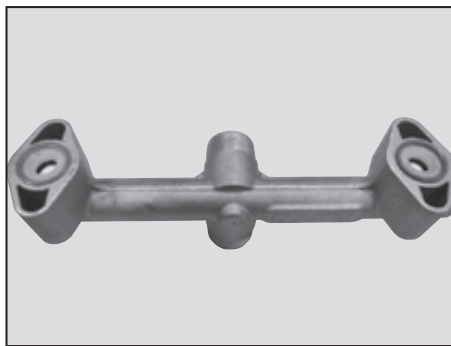

STEP 2

Remove the "Discharge Manifold".



STEP 3

Remove the "O-Ring", "Valve Seat" and "Ball" from the "Discharge Manifold".

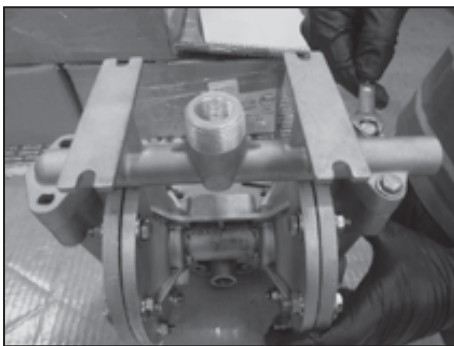

STEP 4

Using the $\frac{7}{16}$ inch wrench remove four "Hex-Head Cap Screws ($\frac{1}{4}$ "-20 x 1- $\frac{3}{4}$ ")" and four "Flat Washers ($\frac{1}{4}$ ")" from the "Suction Manifold".

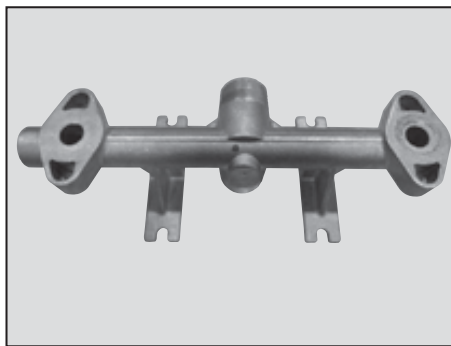

STEP 5

Remove the "Suction Manifold".

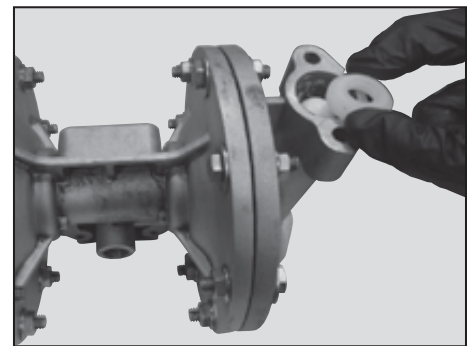

STEP 6

Remove the "O-Ring", "Valve Seat" and "Ball" from the "Suction Manifold".

DOUBLE DIAPHRAGM PUMP MODEL A050 M 12.7 MM

REPAIR AND ASSEMBLY : PUMP WET END (CONT'D)

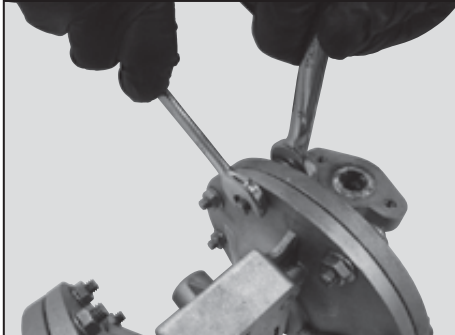

STEP 7

In order to remove "Outer Chambers", using two ½ inch wrenches, remove eight "Hex Head Cap Screws (5/16"-18 x 1-3/4)", eight "Flat and Lock Washers (5/16")" and eight "Hex Flange Nuts (5/16"-18)" from each side.

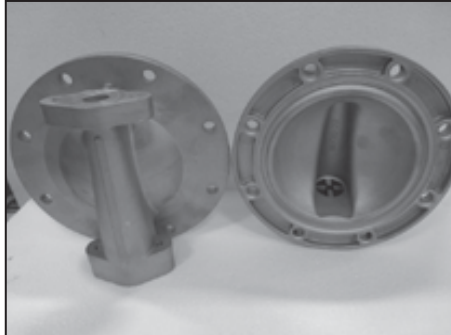

STEP 8

Remove both "Outer Chambers" from the "Intermediate".



STEP 9

Using two ¾ Inch wrenches, remove "Outer Diaphragm Plate", "Diaphragm", "Inner Diaphragm Plate" and "Flat Washer (1/4")" from one side of the pump.



STEP 10

Placing the ¾ inch wrench on the remaining "Outer Diaphragm Plate", and the 7/16 inch wrench on the "Diaphragm Rod Assembly", remove the remaining "Outer Diaphragm Plate", "Diaphragm", "Inner Diaphragm Plate" and "Flat Washer (1/4")" from the other side of the pump.

DOUBLE DIAPHRAGM PUMP MODEL A050 M 12.7 MM

REPAIR AND ASSEMBLY : AIR VALVE (CONT'D)

TOOLS NEEDED

- 1) One Wrench, $\frac{7}{16}$ Inch
- 2) One Pick, General Purpose
- 3) One Pair of Pliers

! WARNING Prior to servicing the pump, ensure that the air and fluid lines are closed and disconnected. While wearing personal protective equipment, flush, drain and process liquid from the pump in a safe manner.

! WARNING Maintenance must not be performed when a hazardous atmosphere is present.

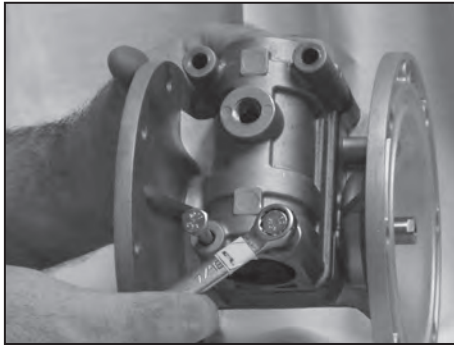

STEP 1

Using the $\frac{7}{16}$ inch wrench, remove four "Hex Head Cap Screws (1/4" - 20)", four "Lock Washers (1/4")" and four "Flat Washers (1/4")".



STEP 2

Remove the main "Air-Valve Assembly" from the pump.

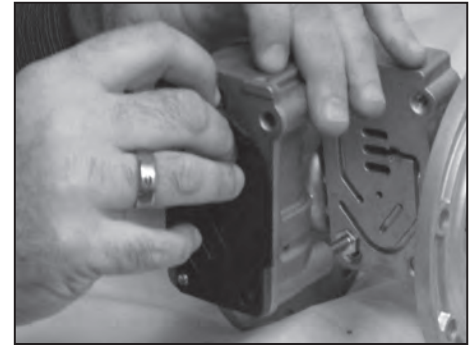

STEP 3

Remove the "Air-Valve Gasket" from the main "Air-Valve Assembly".

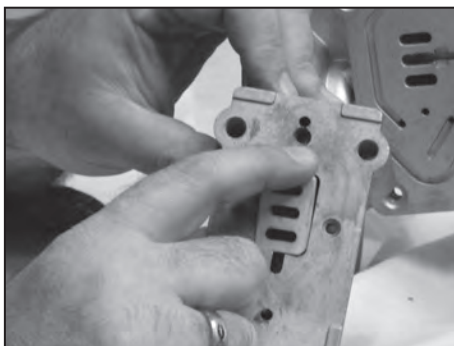

STEP 4

Remove the "Shuttle Plate" from the main "Air-Valve Assembly".

Note: The smooth shiny side of the shuttle plate should be toward the shuttle car.



STEP 5

Remove the "Shuttle" from the main "Air-Valve Assembly".



STEP 6

Using the pair of pliers, remove the "Air Valve End Plug" from the main "Air-Valve Assembly".

Ensure the "O-Ring" is installed when reassembling.

DOUBLE DIAPHRAGM PUMP MODEL A050 M 12.7 MM

REPAIR AND ASSEMBLY : AIR VALVE (END)



STEP 7

Remove the "Air Valve Spool" from the main "Air-Valve Assembly".

Note: Insert larger chamfer first. The smaller chamfer is to be on the plug side.

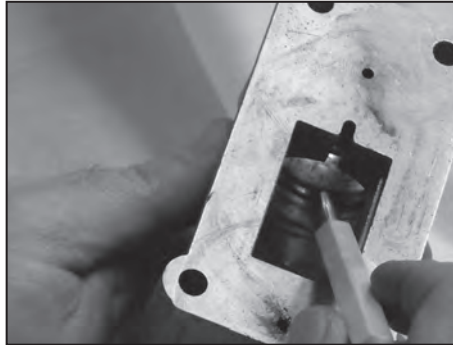

STEP 8

Using the pick, remove the "Lip Seal (Air Valve)" from the main "Air-Valve Assembly".



STEP 9

Using the pick, remove the second "Lip Seal (Air Valve)" from the main "Air-Valve Assembly".

AIR VALVE ASSEMBLY

To assemble the air valve, reverse the order of disassembly. During assembly, ensure that the open side of the lip-seals are both facing each other inward. Install the shuttle plate with the smooth/shiny side toward the shuttle car. Lubrication of the air valve assembly, with a non-synthetic lubricant, is recommended. Magna-Lube or Magna-Plate are recommended for assembly lubrication (see detailed parts list for ordering information).

Note that if the lip-seals are installed incorrectly, they will be unable to rotate. Insert the spool, larger chamfer first, smaller chamfer to be on the plug side (longer piston/smaller boss), ensure O-ring is installed and then the air-valve end plug into position.

DOUBLE DIAPHRAGM PUMP MODEL A050 M 12.7 MM

REPAIR AND ASSEMBLY : PILOT VALVE

REMOVAL

TOOLS NEEDED

- 1) One Screwdriver, #2 Phillips
- 2) Two Wrenches, 7/16 Inch

! WARNING Prior to servicing the pump, ensure that the air and fluid lines are closed and disconnected. While wearing personal protective equipment, flush, drain and process liquid from the pump in a safe manner.

! WARNING Maintenance must not be performed when a hazardous atmosphere is present.

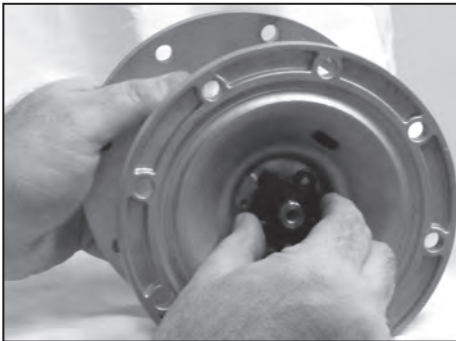

STEP 1

Using the screwdriver, remove three "Phillips Pan-Head Screws (#6-32)" in order to remove the "Retaining Plate". Repeat for both sides of the pump.



STEP 2

Remove the diaphragm rod and the pilot sleeve assembly from the "Intermediate".

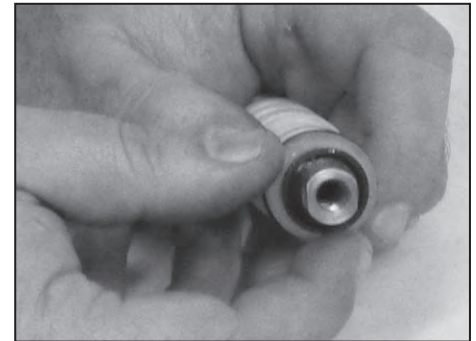

STEP 3

Remove both "Lip Seals (Diaphragm Rod)" and both "End Spacers (Pilot Sleeve)" from the pilot sleeve assembly. Remove both "O-Rings (End Spacer)" from both "End Spacers (Pilot Sleeve)".



STEP 4

Remove three "Inner Spacers (Pilot Sleeve)" and four "O-Rings (Pilot Sleeve)" from the pilot sleeve assembly.



STEP 5

Using two 7/16 inch wrenches, disassemble the "Diaphragm Rod Assembly" into its two parts.

Note: They are installed with thread locker.



STEP 6

Remove the "Pilot Sleeve" from the disassembled "Diaphragm Rod Assembly".

DOUBLE DIAPHRAGM PUMP MODEL A050 M 12.7 MM

REPAIR AND ASSEMBLY : PILOT VALVE

ASSEMBLY

To assemble the pilot valve, reverse the order of disassembly. Should process fluid have contact with the pilot valve O-Rings, they should be replaced as swelling may occur and cause irregular operation. During assembly, ensure that the open side of the lip-seals are facing outward.

Lubrication of the pilot sleeve assembly, with a non-synthetic lubricant, is recommended in order to facilitate re-assembly into the intermediate.

Magna-Lube or Magna-Plate are recommended for assembly lubrication (see detailed parts list for ordering information).

RECOMMENDED TORQUE SPECIFICATIONS

	1/2" Pumps	Wrench Size
Manifold Bolts	78 in-lb (8.8 N-m)	7/16"
Chamber Bolts	85 in-lb (9.6 N-m)	1/2"
Air Valve Bolts	40 in-lb (4.5 N-m)	7/16"
Diaphragm plate	70 in-lb (7.9 N-m)	3/4"
Diaphragm plate (PTFE)	70 in-lb (7.9 N-m)	3/4"

DOUBLE DIAPHRAGM PUMP MODEL A050 M 12.7 MM

EXPLODED VIEW

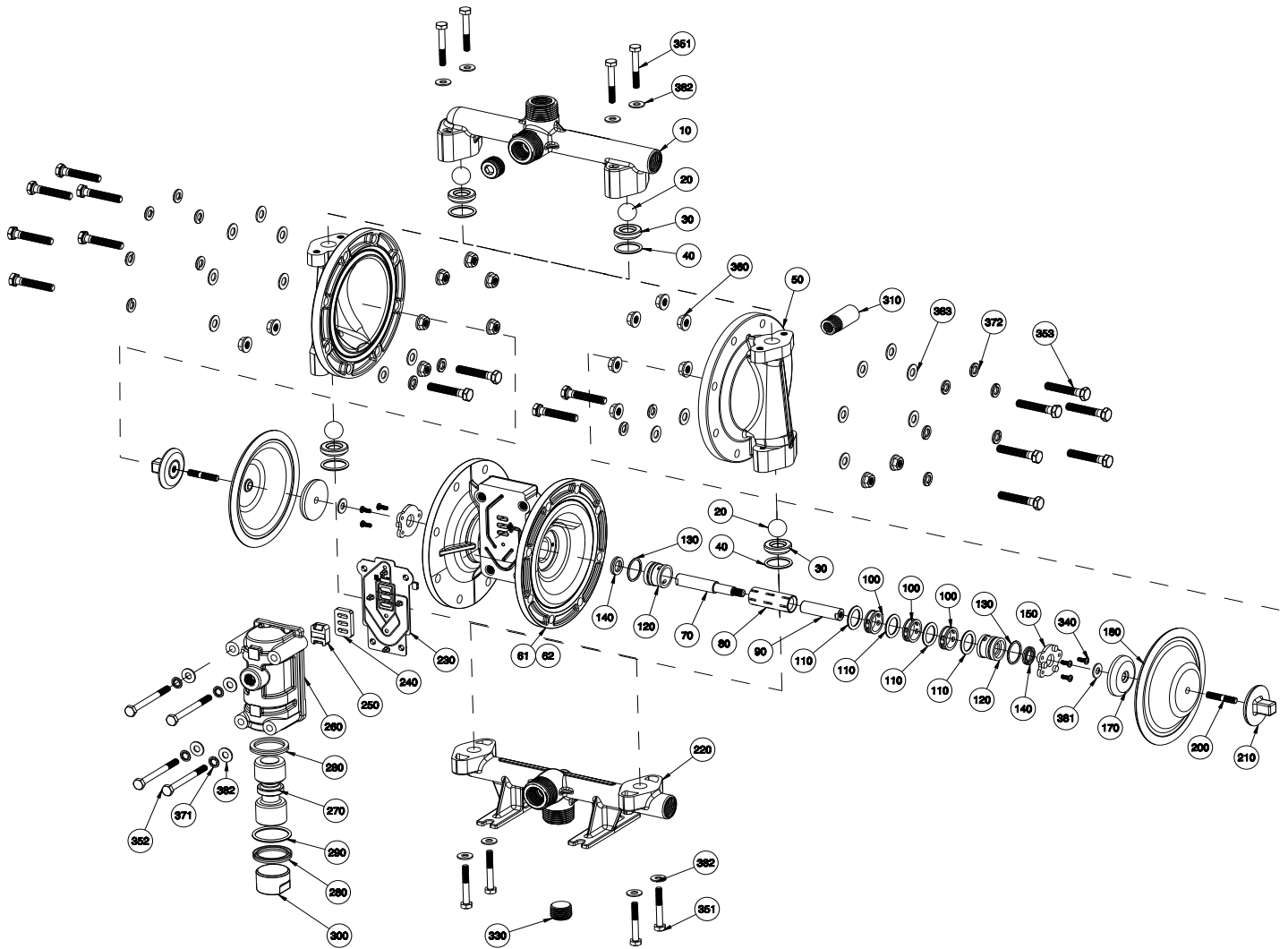
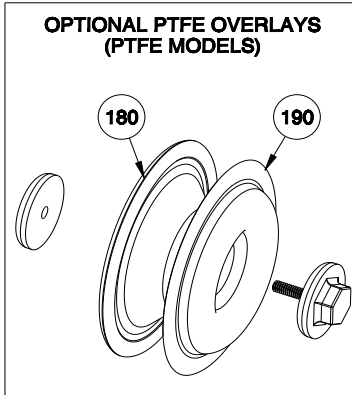

DOUBLE DIAPHRAGM PUMP MODEL A050 M 12.7 MM

PARTS LIST

ITEM	DESCRIPTION	QTY	PUMP MODEL	PART NO.	MATERIAL
10	DISCHARGE MANIFOLD	1	A050-N*A-****-0**	11329-20-NPT	Aluminum
			A050-B*A-****-0**	11329-20-BSPT	Aluminum
			A050-N*3-****-0**	11329-26-NPT	Stainless Steel
			A050-B*3-****-0**	11329-26-BSPT	Stainless Steel
20	BALL	4	A050-***.V***.***	11000-13 †	Viton® /FKM
			A050-***.G***.***	11000-19 †	Geolast®
			A050-***.S***.***	11000-23 †	Santoprene®
			A050-***.3***.***	11000-26 †	Stainless Steel
			A050-***.T***.***	11000-45 †	PTFE
30	VALVE SEAT	4	A050-***.A***.***	10900-20 †	Aluminum
			A050-***.3***.***	10900-26 †	Stainless Steel
			A050-***.P***.***	10900-40 †	Polypropylene
			A050-***.Y***.***	10900-42 †	Nylon
40	O-RING (VALVE SEAT)	4	A050-***.K***.***	10900-56 †	PVDF
			A050-***.N***.***	11904-11 †	Nitrile
			A050-***.V***.***	11904-13 †	Viton® /FKM
			A050-***.E***.***	11904-15 †	EPDM
40	O-RING (VALVE SEAT)	4	A050-***.T***.***	11904-17 †	PTFE
			A050-***.A***.***	10720-20	Aluminum
			A050-***.3***.***	10720-26	Stainless Steel
			A050-***.A***.***	11527-20	Aluminum
61 & 62	INTERMEDIATE	1	ALL MODELS	33000-00	Stainless Steel
70 & 90	DIAPHRAGM ROD ASSEMBLY	1	ALL MODELS	10105-31 Δ	Acetel
80	PILOT SLEEVE	1	ALL MODELS	10203-40 Δ	Polypropylene
100	INNER SPACER (PILOT SLEEVE)	3	ALL MODELS	11920-16 Δ	Urethane
110	O-RING (PILOT SLEEVE)	4	ALL MODELS	10204-40 Δ	Polypropylene
120	END SPACER (PILOT SLEEVE)	2	ALL MODELS	11923-11 Δ	Nitrile
130	O-RING (END SPACER)	2	ALL MODELS	12000-76 Δ	Nitrile
140	LIP SEAL (DIAPHRAGM ROD)	2	ALL MODELS	12708-54	Nylon
150	RETAINING PLATE	2	ALL MODELS		
160	N/A				
170	INNER DIAPHRAGM PLATE	2	ALL MODELS	11100-40	Polypropylene
180	DIAPHRAGM	2	A050-***.V***.***	10600-13 †	Viton® /FKM
			A050-***.G***.***	10600-19 †	Geolast®
			A050-***.N***.***	10600-21 †	Nitrile
			A050-***.S***.***	10600-23 †	Santoprene®
			A050-***.T***.***	10600-23 †	Santoprene®
190	OVERLAY (OPTIONAL)	2	A050-***.T***.***	11400-59 †	PTFE
200 & 210	OUTER DIAPHRAGM PLATE	2	A050-***.A***.***	11208-20	Aluminum
			A050-***.3***.***	11208-26	Stainless Steel
220	SUCTION MANIFOLD	1	A050-N*A-****-0**	11328-20-NPT	Aluminum
			A050-B*A-****-0**	11328-20-BSPT	Aluminum
			A050-N*3-****-0**	11328-26-NPT	Stainless Steel
			A050-B*3-****-0**	11328-26-BSPT	Stainless Steel
230	AIR VALVE GASKET	1	ALL MODELS	12126-19 ‡	Nitrile
240	SHUTTLE PLATE	1	ALL MODELS	10416-77 ‡	Ceramic
250	SHUTTLE	1	ALL MODELS	10415-00 ‡	Special
260	AIR VALVE BODY	1	A050-***.A***.***	42001-20 ‡	Aluminum
270	AIR VALVE SPOOL	1	ALL MODELS	10480-31 ‡	Acetel
280	LIP SEAL (AIR VALVE)	2	ALL MODELS	12003-76 ‡	Nitrile
290	O-RING (AIR VALVE END PLUG)	1	ALL MODELS	11913-11 ‡	Nitrile

DOUBLE DIAPHRAGM PUMP MODEL A050 M 12.7 MM

PARTS LIST (CONT'D)

ITEM	DESCRIPTION	QTY	PUMP MODEL	PART NO.	MATERIAL
300	AIR VALVE END PLUG	1	A050-*A*-*-*-*-*	11706-20 ‡	Aluminum
310	MUFFLER MUFFLER (METAL)	1	ALL MODELS Optional	13008-00 13002-00	Standard Metal
320	N/A				
330	PIPE PLUG	2	A050-N*A*-*-*-*-* A050-B*A*-*-*-*-* A050-N*3-*-*-*-* A050-B*3-*-*-*-*	12255-20-NPT 12255-20-BSPT 12255-26-NPT 12255-26-BSPT	Aluminum Aluminum Stainless Steel Stainless Steel
340	PAN-HEAD MACH SCREW (#6-32 x 7/16)	6	A050-**A*-*-*-*-*	12585-26	Stainless Steel
351	HEX HEAD CAP SCREW (1/4"-20 x 1-3/4")	8	A050-**A*-*-*-*-* A050-**3-*-*-*-*	12500-25 12500-26	Plated Steel Stainless Steel
352	HEX HEAD CAP SCREW (1/4"-20 x 2-3/4")	4	A050-**AA*-*-*-*-* A050-**A3*-*-*-*-*	12576-25 12576-26	Plated Steel Stainless Steel
353	HEX HEAD CAP SCREW (5/16-18 x 1-3/4")	16	A050-**A*-*-*-*-* A050-**3-*-*-*-*	12503-25 12503-26	Plated Steel Stainless Steel
360	HEX FLANGE NUT (5/16"-18)	16	A050-**A*-*-*-*-* A050-**3-*-*-*-*	12608-25 12608-26	Plated Steel Stainless Steel
371	LOCK WASHER (1/4")	4	A050-**A*-*-*-*-* A050-**3-*-*-*-*	12350-25 12350-26	Plated Steel Stainless Steel
372	WASHER, SPLIT LOCK (5/16")	16	A050-**A*-*-*-*-* A050-**3-*-*-*-*	12313-25 12313-26	Plated Steel Stainless Steel
381	WASHER (1/4")	2	ALL MODELS	12300-26	Stainless Steel
382	WASHER (1/4")	12 12	A050-**A*-*-*-*-* A050-**3-*-*-*-*	12300-25 12300-26	Plated Steel Stainless Steel
383	WASHER (5/16")	16	A050-**A*-*-*-*-* A050-**3-*-*-*-*	12310-25 12310-26	Plated Steel Stainless Steel
390	N/A				
400		1	OPTIONAL	13481-20	Aluminum
-/-	Magnalube® .75 oz. (As Required)	-/-	ALL MODELS	13404-00	Grease

* Any Character

‡ , Δ Only sold as part of assembly

ASSEMBLY PART NUMBERS	PUMP MODEL	PART NO.	MATERIAL
‡ AIR VALVE ASSEMBLY INCLUDES 230, 240, 250, 260, 270, 280, 290, 300	A050-*A*-*-*-*-*	AMK-050-A	Various
Δ PILOT SIEVE ASSEMBLY INCLUDES 80, 100, 110, 120, 130, 140	A050-*A*-*-*-*-*	APK-050-A	Various
† WET END REPAIR KIT 20, 30, 40, 180, 190	A050-*A*-*-*-*-*	AWE-050-****-M	Various

DOUBLE DIAPHRAGM PUMP MODEL A050 M 12.7 MM

WETTED ELASTOMERS

BUNA-N (NITRILE)

is a general purpose elastomer used with water and many oils. Temperature range 10°F to 180°F (-12C to 82C).

GEOLAST®

is an injection molded thermoplastic material with characteristics similar to Nitrile. Has excellent abrasion resistance. Temperature range 10°F to 180°F (-12C to 82C).

EPDM

is a general purpose elastomer with good resistance to many acids and bases. Temperature range -40°F to 280°F (-40C to 138C).

SANTOPRENE®

is an injection molded material with characteristics similar to EPDM. Has excellent abrasion resistance. Temperature range -40°F to 225°F (-40C to 107C).

VITON®

is an elastomer with good corrosion resistance to a wide variety of chemicals. Temperature range -40°F to 350°F (-40C to 177C).

FKM

is an elastomer with good corrosion resistance to a wide variety of chemicals. Similar in chemical resistance to Viton®. Temperature range -40°F to 350°F (-40C to 177C).

PTFE (POLYTETRAFLUOROETHYLENE)

is a thermoplastic polymer that is inert to most chemicals. Similar in chemical resistance to Teflon®. Temperature range 40°F to 220°F (4C to 104C).

Most of the above elastomers are available in FDA approved formulations.

Viton® is a registered trademark of DuPont Performance Elastomers L.L.C.
Geolast® is a registered trademark of ExxonMobil Chemical Co.
Santoprene® is a registered trademark of ExxonMobil Chemical Co.
Teflon® is a registered trademark of DuPont Performance Elastomers L.L.C.
Hytrel® is a registered trademark of DuPont Performance Elastomers L.L.C.
Magnalube® is a registered trademark of Carleton-Stuart Corp.



II 2 GD c TX

Warning: The TX marking refers to the maximum surface temperature depending not on the equipment itself, but mainly on operating conditions. In this case, the maximum surface temperature depends upon the temperature of the process fluids.

DOUBLE DIAPHRAGM PUMP MODEL A050 M 12.7 MM

WARRANTY AND REGISTRATION

All All-Flo products shall be covered by the standard All-Flo Limited Warranty in effect at the time of shipment. This warranty (which may be modified by All-Flo at any time) provides:

MATERIALS SOLD ARE WARRANTED TO THE ORIGINAL USER AGAINST DEFECTS IN WORKMANSHIP OR MATERIALS UNDER NORMAL USE (RENTAL USE EXCLUDED) FOR FIVE YEARS AFTER PURCHASE DATE. ANY PUMP WHICH IS DETERMINED TO BE DEFECTIVE IN MATERIAL AND WORKMANSHIP AND RETURNED TO ALL-FLO, SHIPPING COSTS PREPAID, WILL BE REPAIRED OR REPLACED AT ALL-FLO'S OPTION. CUSTOMER SHALL NOTIFY ALL-FLO IN WRITING WITHIN 30 DAYS OF ANY CLAIMED DEFECTS. NO MATERIALS CAN BE RETURNED WITHOUT THE PRIOR CONSENT OF ALL-FLO, AND IF APPROVED SHALL BE RETURNED TO ALL-FLO FREIGHT PREPAID. ALL-FLO'S LIABILITY FOR ANY BREACH OF THIS WARRANTY SHALL BE LIMITED TO EITHER REPLACEMENT OF THE MATERIALS OR, AT ALL-FLO'S SOLE OPTION, THE REFUND OF THE PURCHASE PRICE. ALL-FLO SHALL NOT BE HELD LIABLE FOR ANY INCIDENTAL OR CONSEQUENTIAL DAMAGES CAUSED BY BREACH OF THIS WARRANTY. THIS EXCLUSION APPLIES WHETHER SUCH DAMAGES WERE SOUGHT BASED ON BREACH OF WARRANTY, BREACH OF CONTRACT, NEGLIGENCE, STRICT LIABILITY IN TORT, OR ANY OTHER LEGAL THEORY. FURTHER, ALL-FLO SHALL NOT BE LIABLE FOR LOSSES, DELAYS, LABOR COSTS, OR ANY OTHER COST OR EXPENSE DIRECTLY OR INDIRECTLY ARISING FROM THE USE OF MATERIALS. ALL-FLO'S LIABILITY IS EXPRESSLY LIMITED TO THE REPLACEMENT OR REPAIR OF DEFECTIVE GOODS, OR THE TOTAL VALUE OF SUCH GOODS. THIS WARRANTY IS IN LIEU OF ALL OTHER WARRANTIES, WHETHER EXPRESS, IMPLIED, OR ORAL INCLUDING THE IMPLIED WARRANTY OF MERCHANTABILITY, ANY IMPLIED WARRANTY OF FITNESS FOR A PARTICULAR PURPOSE, AND ANY IMPLIED WARRANTIES OTHERWISE ARISING FROM A COURSE OF DEALING OR TRADE.

All-Flo will not, in ANY event, be liable for any loss of profit, interruption of business or any other special, consequential or incidental damages suffered or sustained by Customer. All-Flo's total maximum liability to the customer in respect of sale of materials or services rendered by All-Flo is limited to the total monies received by All-Flo from the customer for the particular materials described in Customer's order.

All-Flo does not warrant any part or component that it does not manufacture, but will assign to the original end-user purchaser of any warranty received by it from the manufacturer, to extent such pass through is permitted by the manufacturer.

REGISTRATION FORM



Pump Model _____ Pump Serial Number _____

Company Name _____

Name _____ Email _____

Phone # _____ City _____ State _____ Zip _____

Qty of Pumps _____ Fluid Pumping _____

How did you hear about us? Existing All-Flo user,
Web, Distributor, Magazine...

MAIL TO: All-Flo Pump Co. | Attn: Product Registration
PO BOX 1870 | Mentor, OH 44061



Scan QR code and complete form on mobile phone or visit

www.all-flo.com/registration-form.html

ELECTRICAL BOX GRM (EB1)

EXPLOSION PROOF BOX (EB1)

DESIGNED BY:	VINCENT	DATE:	2020-11-02
CONCLU PAR:	VINCENT	REVISION:	0
DRAWN BY:	VINCENT	DWG. NO.:	GRM_SR126-SR240
DESSINE PAR:	VINCENT	NO. DESSIN:	
CHECKED BY:		SCALE:	1:3
VÉRIFIÉ PAR:		PAGE:	1 OF 1

For mechanical thread ASSY on enclosure and heater, A minimum of 4 threads hand tightened must be inserted before applying mechanical force with tools

1 Pitch: 14 threads per inch
Number of threads: 7.44 threads
Overall External thread length: 0.7935"

3 5 threads minimum must be engaged after applying mechanical torque with air tool set at 90 PSI for all threaded ASSY

4 Pitch: 0.7 mm
Number of threads: 15.73 threads
Standard thread length: 1.4 mm

5

SECTION A-A
SCALE 1:3

EXPLOSION PROOF BOX (EB1)

DESIGNED BY:	VINCENT	DATE:	2020-11-02
CONCLU PAR:	VINCENT	REVISION:	0
DRAWN BY:	VINCENT	DWG. NO.:	GRM_SR126-SR240
DESSINE PAR:	VINCENT	NO. DESSIN:	
CHECKED BY:		SCALE:	1:3
VÉRIFIÉ PAR:		PAGE:	1 OF 1

ISTpure
1050 Des Forges Street, Hwy. 640 Industrial Park
Terrebonne, QC Tel 1 877 629-8202 • 450 963-4400

TOLERANCE DE FABRICATIONS

TOLERIE/SOUDURE	MACHINAGE
FRACTIONS: ±1/16"	FRACTIONS: ±1/32"
DECIMAL: XX: ±0.015	DECIMAL: XXX: ±0.003
PLIAGE/BENDING: ±1°	

EXCLUSIVE RIGHTS
THIS DRAWING IS THE EXCLUSIVE PROPERTY OF IST SURFACE INC. INFORMATION CONTAINED HEREIN CAN BE USED ONLY WHEN SPECIFICALLY AUTHORIZED BY IST SURFACE INC. POSSESSION OF THIS DRAWING DOES NOT AUTHORIZE USE NOR TRANSMISSION TO ANY OTHER ORGANISATION.

DROITS D'AUTEUR
CE DESSIN EST LA PROPRIÉTÉ DE IST SURFACE INC. LES INFORMATIONS QU'IL CONTIENT NE PEUVENT ÊTRE UTILISÉES QU'AVEC L'ACCORD PRÉALABLE DE IST SURFACE INC. LA POSSESSION DE CE DESSIN N'AUTORISE NI L'UTILISATION NI LA TRANSMISSION A QUICONQUE LES INFORMATIONS QU'IL CONTIENT

Note: (For Group II, IIA and IIB Ex component enclosure) the content of the Ex component enclosure equipment may be placed in any arrangement, provided that an area of at least 20% of each cross-sectional area remains free to permit an unimpeded gas flow and, therefore, unrestricted development of an explosion. Separate relief areas may be aggregated provided that each area has a minimum dimension in any direction of 12.5 mm:

ELECTRICAL BOX GRB (EB2)

1 For mechanical thread ASSY on enclosure and heater, A minimum of 4 threads hand tightened must be inserted before applying mechanical force with tools

2 Pitch : 14 threads per inch
Number of Threads: 6.56 Threads
Overall External thread length : 0.7935"

3 Pitch : 11.5 threads per inch
Number of Threads: 6.33 Threads
Overall External thread length : 1.0582"

4 5 Threads minimum must be engaged after applying mechanical torque with air tool set at 90 PSI for all threaded ASSY

5 Pitch : 0.7 mm
Number of Threads: 15.73 threads
Standard thread length : 14 mm

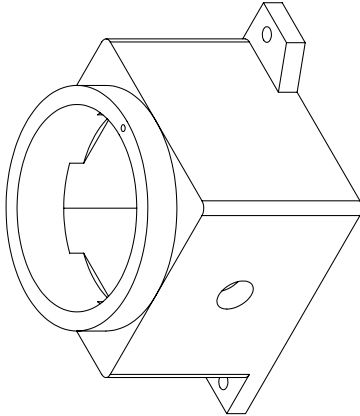
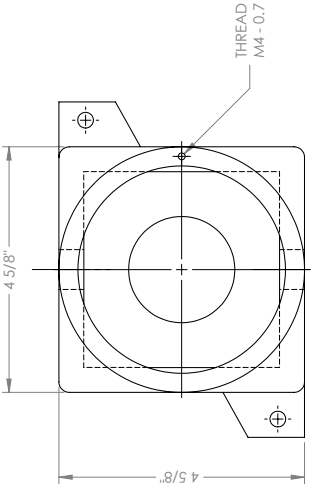
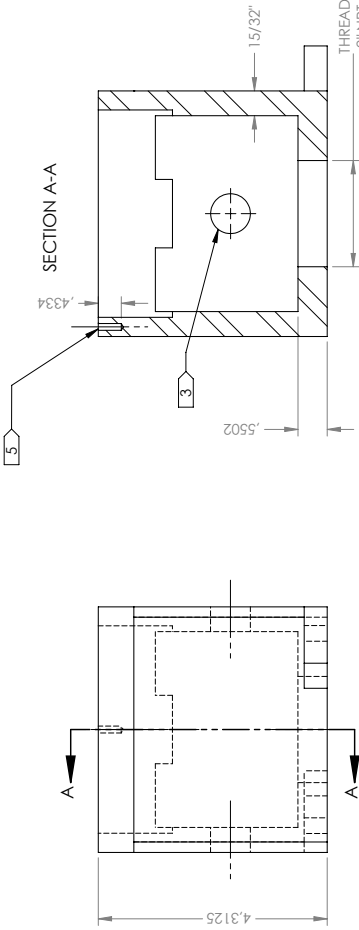
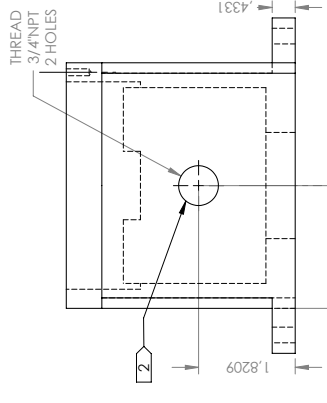
Note: (For Group II, IIA and IIB Ex component enclosures) the content of the Ex component enclosure equipment may be placed in any arrangement, provided that an area of at least 20 % of each cross-sectional area remains free to permit an unimpeded gas flow and, therefore, unrestricted development of an explosion. Separate relief areas may be aggregated provided that each area has a minimum dimension in any direction of 12.5 mm.

EXPLOSION PROOF BOX (EB2)		TOLERANCE DE FABRICATIONS	
DESIGNED BY: VINCENT	DATE: 2020-11-02	TOLERIE/SOLIDURE	MACHINAGE
DRAWN BY: VINCENT	DWG. NO.: GRB_SR60	FRACTIONS: ±1/16"	FRACTIONS: ±1/32"
DESIGNED BY: VINCENT	NO. DESSIN: GRB_SR60	PLIAGE/BENDING: ±1°	DECIMAL :XX: ±0.015
CHECKED BY: VINCENT	SCALE: 1:2	DECIMAL :XXX: ±0.005	
	ECHELLE: 1:2		
	PAGE 1 OF 1		



ISTpure
1050 Des Forges Street, Hwy. 640 Industrial Park
Terrebonne, QC Tel 1 877 629-8202 - 450 963-4400

CE DESSIN EST LA PROPRIETE DE IST SURFACE INC. LES INFORMATIONS QUIL CONTIENT NE PEUVENT ETRE UTILISEES QU'AVEC L'ACCORD PREALABLE DE IST SURFACE INC. LA POSSESSION DE CE DESSIN AUTORISE NI L'UTILISATION NI LA TRANSMISSION A QUICONQUE LES INFORMATIONS QUIL CONTIENT

THIS DRAWING IS THE EXCLUSIVE PROPERTY OF IST SURFACE INC. INFORMATION CONTAINED HEREIN CAN BE USED ONLY WHEN SPECIFICALLY AUTHORIZED BY IST SURFACE INC. POSSESSION OF THIS DRAWING DOES NOT AUTHORIZE USE NOR TRANSMISSION TO ANY OTHER ORGANISATION.

ELECTRICAL BOX GRK (EB3)

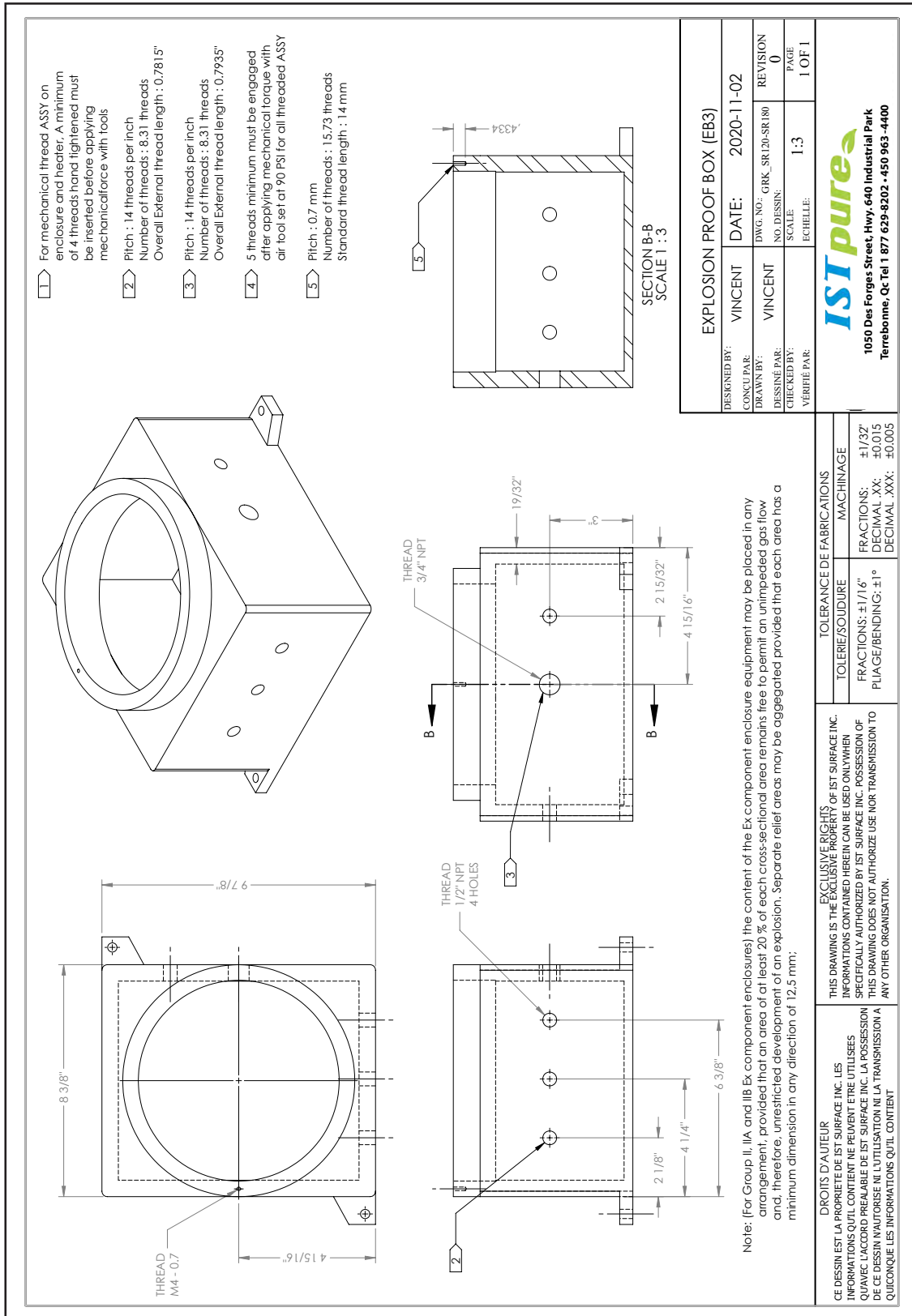

ELECTRICAL BOX GRH (EB4)

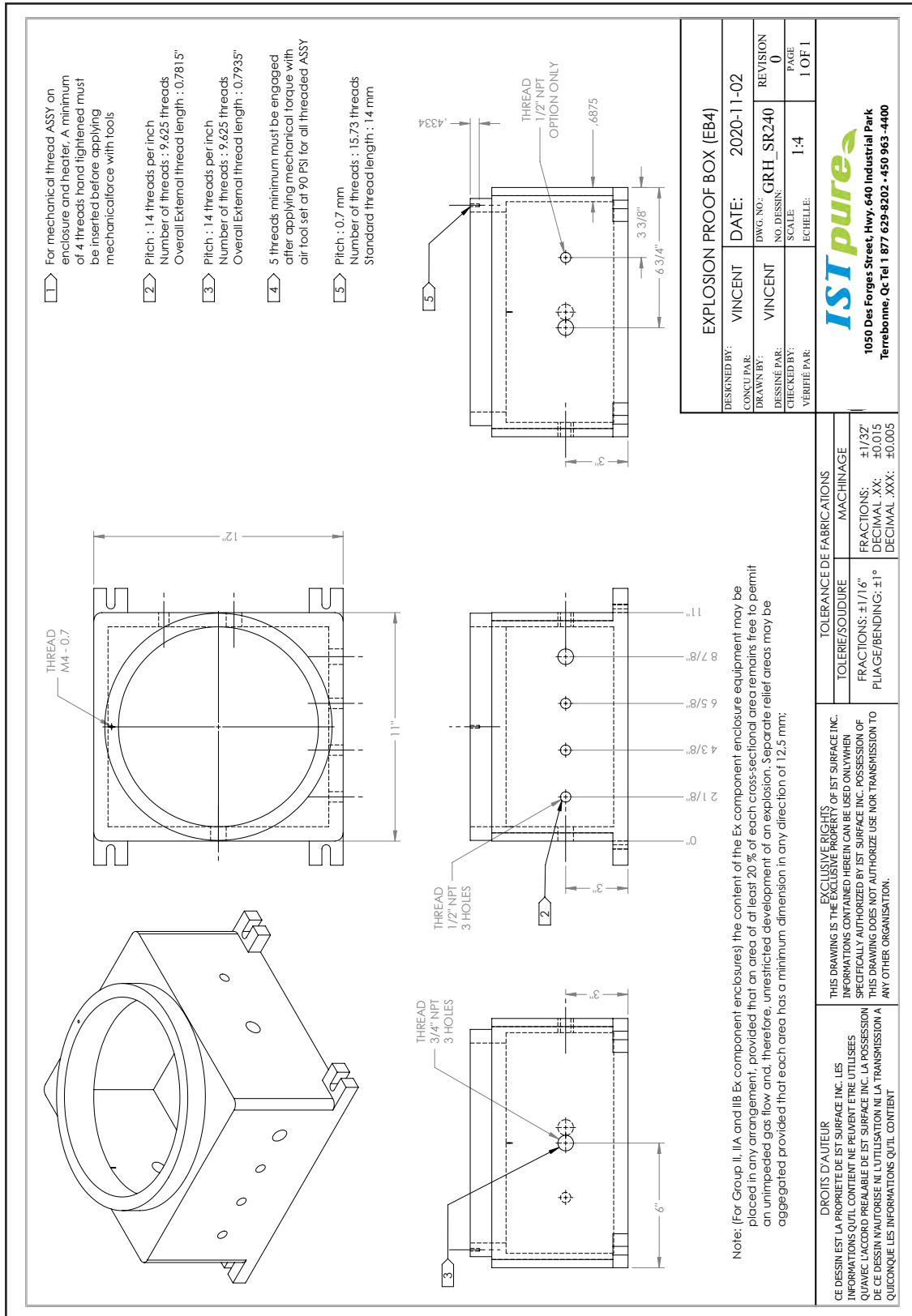

LOADING AND UNLOADING DIAGRAM

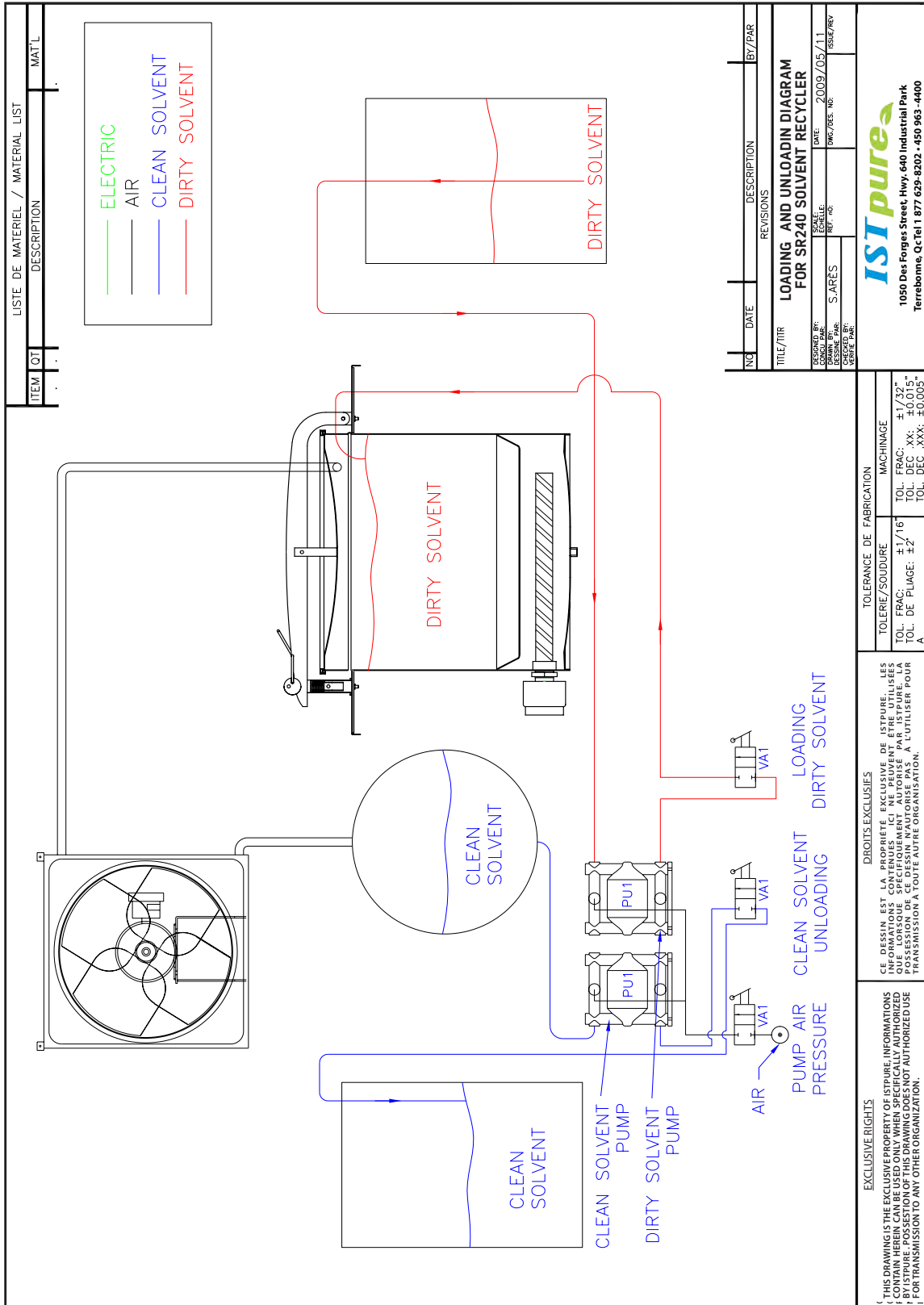

VACUUM OPTION DIAGRAM

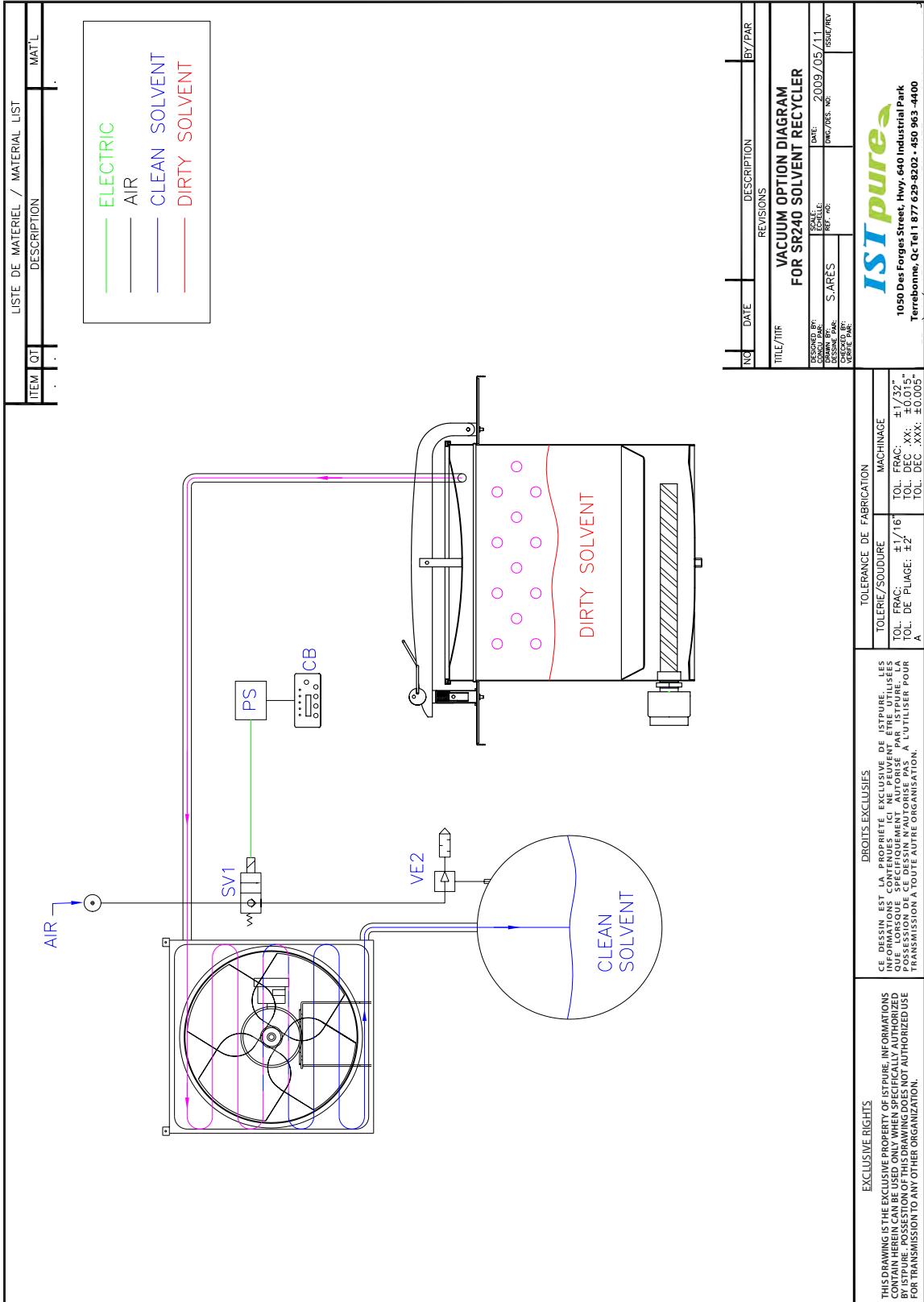

SLUDGE OPTION TEMPERATURE DIAGRAM

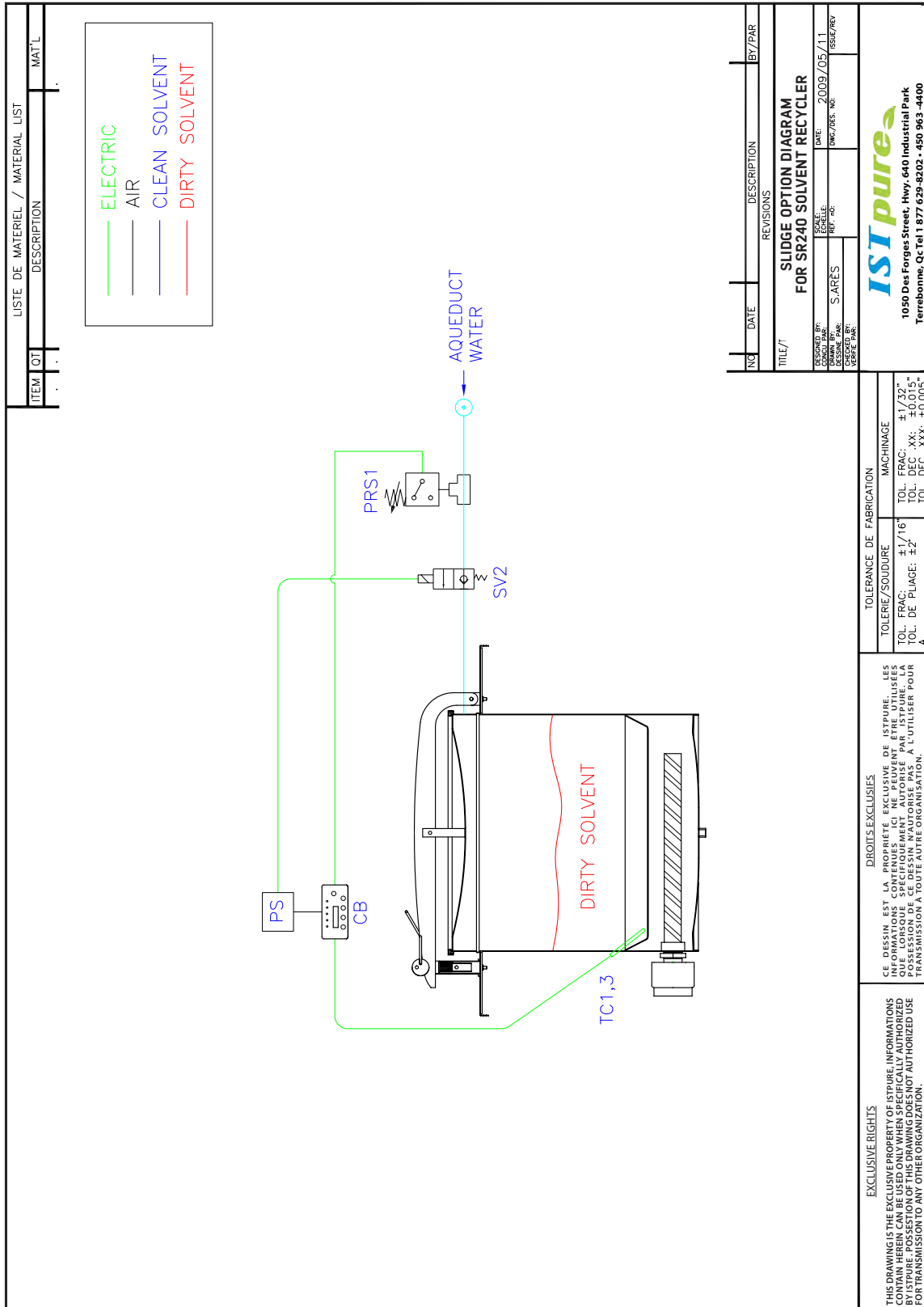

LOADING-UNLOADING & AUTOFILL-UP DIAGRAM

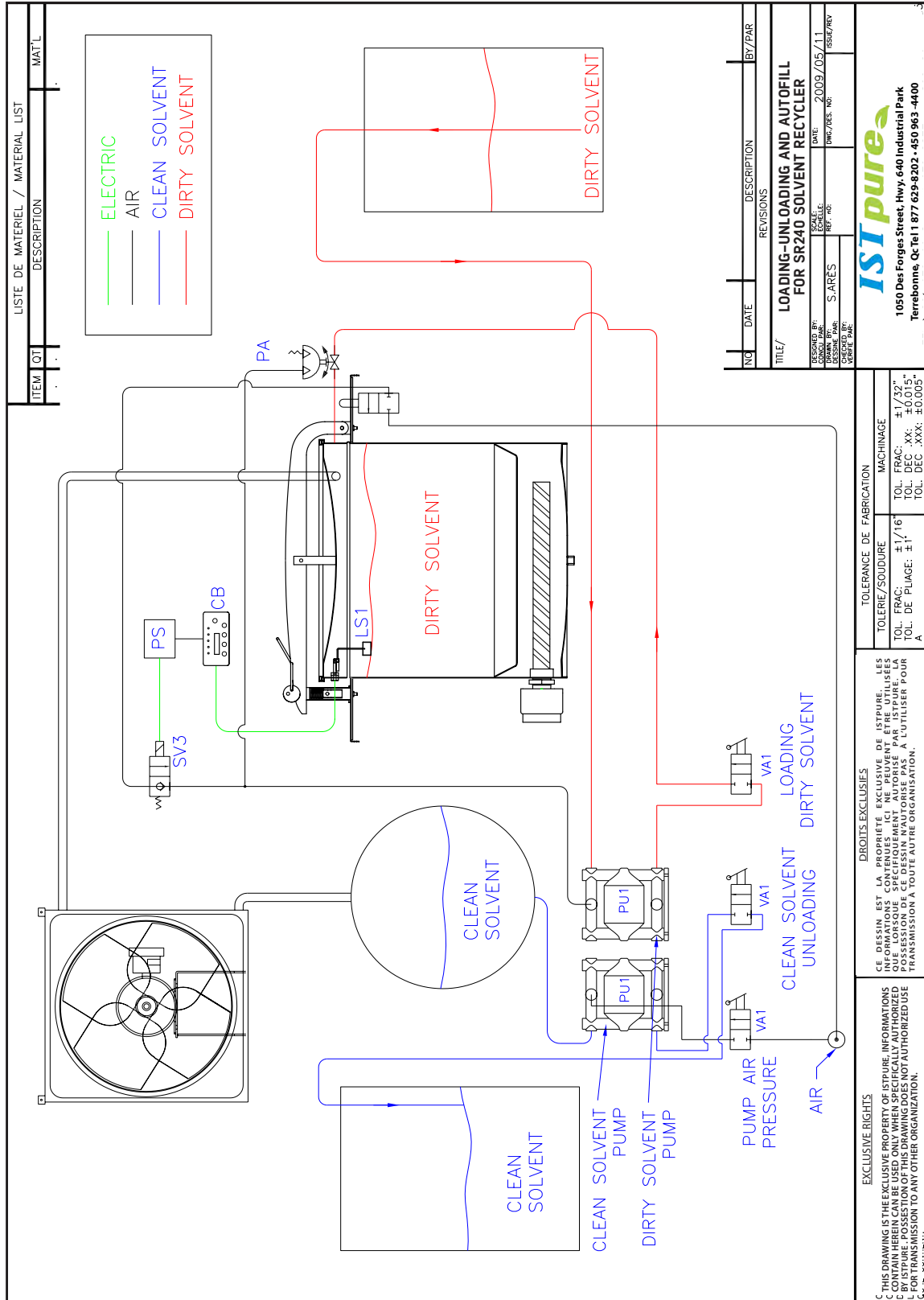

OPTION OIL COOLING - PNEUMATIC DIAGRAM

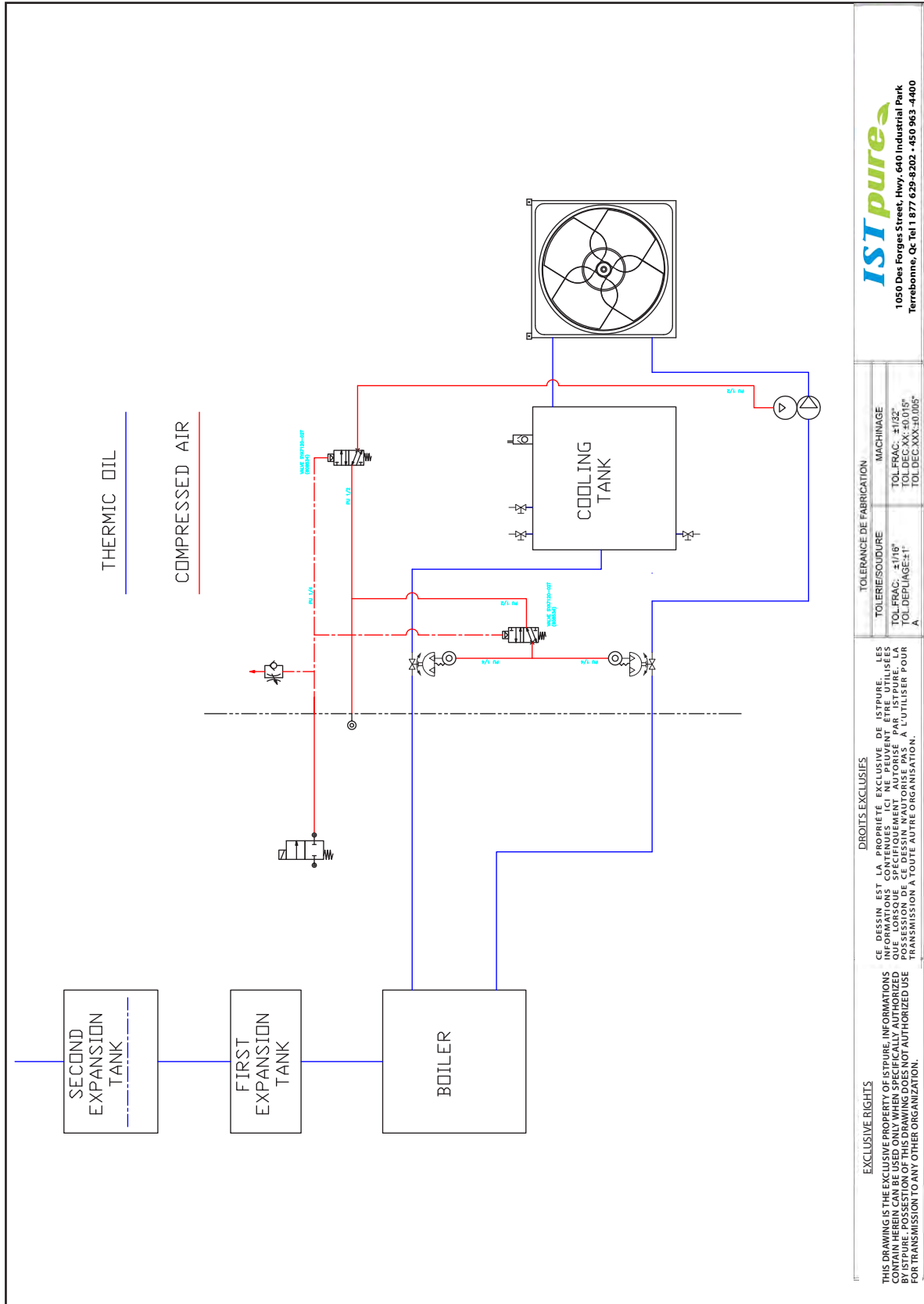

ISTpure
1050 Des Forges Street, Hwy. 640 Industrial Park
TerraBonne, QC, Tel 1 877 629-8202 - 450 963 -4400

TOLERANCE DE FABRICATION	MACHINAGE
TOLERANCE DE FABRICATION	TOLERANCE DE FABRICATION
TOL.FRAC. : ±1/16"	TOL.FRAC. : ±1/32"
TOL.DÉPLACEMENT	TOL.DÉPLACEMENT
TOL.DÉPLACEMENT	TOL.DÉPLACEMENT

DROITS EXCLUSIFS
CE Dessin est la propriété exclusive de ISTPURE. LES DROITS EXCLUSIFS DE CE Dessin sont réservés à ISTPURE. LA POSSESSION DE CE Dessin n'autorise pas à l'utiliser pour la transmission à toute autre organisation.

EXCLUSIVE RIGHTS
THIS DRAWING IS THE EXCLUSIVE PROPERTY OF ISTPURE. INFORMATION CONTAINED HEREIN CAN BE USED ONLY WHEN SPECIFICALLY AUTHORIZED BY ISTPURE. POSSESSION OF THIS DRAWING DOES NOT AUTHORIZE USE FOR TRANSMISSION TO ANY OTHER ORGANIZATION.

OPTIONAL VACUUM DISTILLATION SECTION

Examples

Product to be distilled : Perchloroethylene

Distillation temperature at atmospheric pressure : 121°C
 Distillation temperature at vacuum condition (223 mbar) : 84°C
 Critical temperature of decomposition : 150°C

A. Boiling range of clean perchloroethylene at atmospheric pressure: 1,000 mbar.



The distillation temperature of a clean solvent remains the same until the process of the whole cycle is complete.

B. Boiling range of clean perchloroethylene at vacuum condition: 223 mbar



The distillation temperature of a clean solvent remains the same until the process of the whole cycle is complete.

C. Boiling range at atmospheric pressure (1,000 hPa) of a mixture of 90% perchloroethylene + 10% of oil.

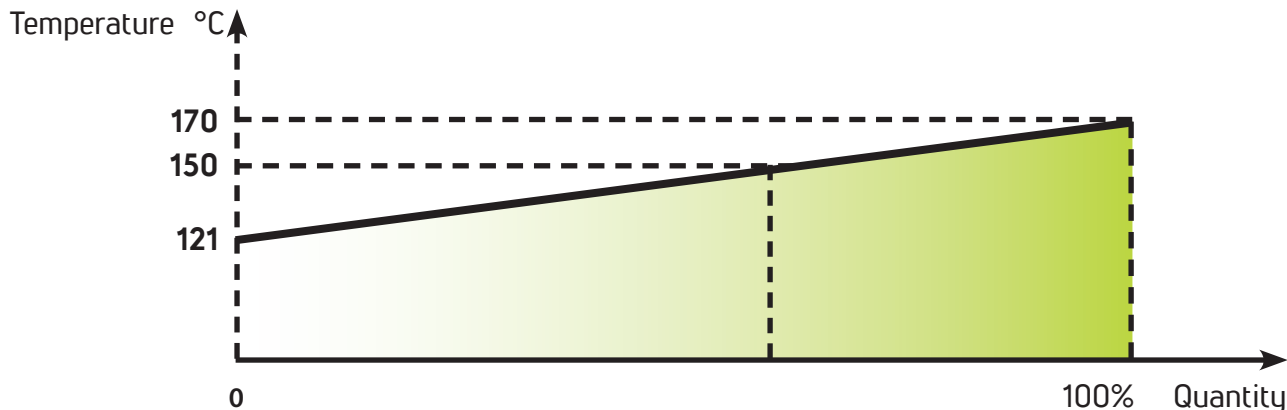

Once a temperature of 150 °C is reached, which is the critical non-supportable temperature, only 80% of perchloroethylene will be recovered.

The distillation temperature of the contaminated solvents increases during the process; this variation depends on the degree of contamination and on the type of contaminating substances.

OPTIONAL VACUUM DISTILLATION SECTION

D. Distillation temperature at vacuum condition (223 mbar) of a mixture of 90% perchloroethylene + 10% of

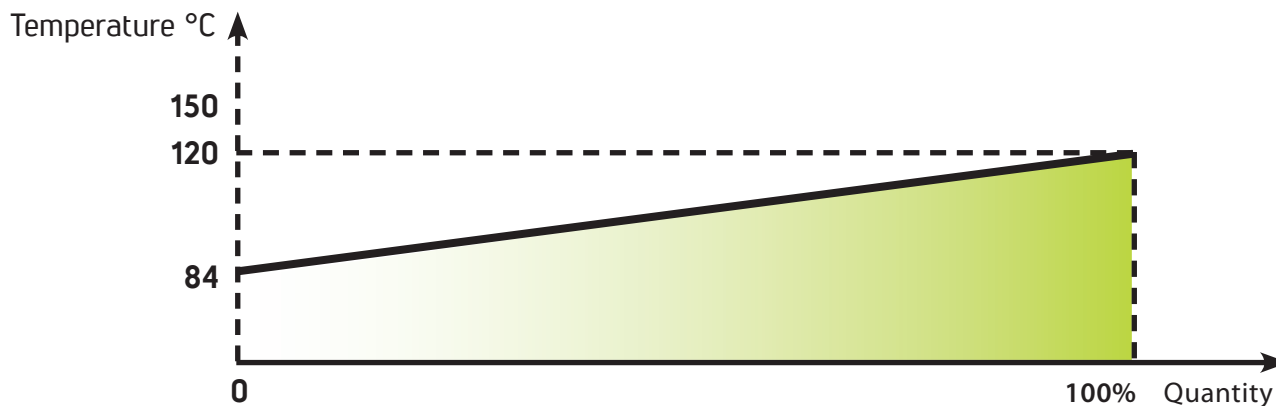

Operating with vacuum condition, 100% of perchloroethylene will be recovered when set at 120 °C and very far from the critical temperature of 150 °C

When distilling chlorinated solvents, the vacuum distillation is indispensable; this type of process is also necessary for minimal quantities of contaminants because of two specific reasons:

1. Yields 100%.
2. If the residual oil is contaminated with more than 2 % of solvent, waste recycling companies will not accept it.

The distillation temperature of the contaminated solvents increases during the process; this variation depends on the degree of contamination and on the type of contaminating substances.

OPERATING PRINCIPLES – VACUUM DISTILLATION

Before reading this section, it is mandatory to read the previous section regarding the distillation at atmospheric pressure.

Unlike what occurs during atmospheric distillation, the distillation unit and the distillate collection tank are a single body.

A pneumatic vacuum generator joined at the solvent recovery tank provides the creation of the vacuum circuit.

Boiler Condenser Tank

The vacuum generator is fed with compressed air with a pressure of 483–690 kPa with a maximum negative pressure of –186 kPa, –590 mm Hg.

NOTE : WITH VACUUM DISTILLATION IT IS POSSIBLE TO DISTILL SOLVENTS WITH DISTILLATION TEMPERATURE HIGHER THAN 60°C AT ATMOSPHERIC PRESSURE.

For example, distilling at vacuum condition the Acetone, which has a distillation temperature of 56 °C at atmospheric pressure, will reach a boiling point of 39 °C. Considering that the condenser is by air, if the temperature result is higher than 20 °C you will obtain a partial condensation of the solvent with an emission of Acetone vapor in the air.

OPERATING METHODS

DISTILLATION : AT ATMOSPHERIC PRESSURE

DRYING : AT VACUUM CONDITIONS

When processing solvents with distillation temperature lower than 60 °C, polluted with liquid products.

DISTILLATION : AT ATMOSPHERIC PRESSURE

DRYING : AT VACUUM CONDITIONS

When processing solvents with distillation temperature higher than 60 °C, polluted with solid products.

DISTILLATION : AT ATMOSPHERIC PRESSURE

DRYING : AT VACUUM CONDITIONS

In this case the process of the solvent reducers distillation temperatures between 60°–200 °C, and polluted with liquid products.

OPERATING PRINCIPLES – VACUUM DISTILLATION

Distillation at Atmospheric Pressure

Defects	Causes	Remedies
No vacuum protection	Lack of compressed air.	Adjust the air pressure.
	Lack of compressed air circuit.	Check the connection.
	Distilling a chlorinated solvent.	Turn off the distillate-unloading tap.
	The rubber tube of connection to distillate container is not perfectly connected.	Check the connection towards the condenser and connection on rapid clutch.
	Rubber tube deteriorated.	Change the rubber tube.
	Lack of distillate level control.	Check the connections.
	The cover does not have a perfect seal.	Place the cover correctly on the shoulder of the boiler.
	Cover gasket deteriorated.	Replace the gasket.
	Solenoid defected.	Replace the solenoid.
	Vacuum pump damaged.	Change the vacuum pump.
During the distillation distillate comes out dirty.	Solvent foams.	Use anti-foaming discs, see page 17.
		Load less quantity of solvent.
		Reduce working temperature.
		Reduce the compressed air feeding.
		Wait at least 48 hours after utilizing the solvent before starting the next distillation.
During drying distillate pigments.	Draws polluted products.	Separate the distillation phase than the drying ones. At the end of the distillation discharge the distillate tank and proceed to dry. At the end of drying wash the tank.

INFORMATION / TECHNICAL ASSISTANCE

ISTpure is a registered trademark of:



For more information, pricing or technical support, contact your local IST distributor or call / fax to our Consumer Information

TEL.: 1 877 629-8202 & 450 963-4400

Or visit us at:
istsurface.com

ABOUT THE COMPANY

WHO WE ARE

IST is a leading manufacturer of equipment for the surface treatment industry and the solvent recycling industry. Our extensive line of equipment includes batch units and automated machines designed to achieve the highest manufacturing standards.

MISSION

IST works tightly with their customers to transform industrial processes to improve their quality, productivity, and environmental footprint.

OUR SERVICES

- Custom Design & Fabrication
- Installation & Startup
- Preventative Maintenance Program
- Private Labels
- Testing Lab
- 24/7 Technical Support

INDUSTRIES WE SERVE

- Aerospace & Aviation
- Aluminium Smelters
- Automotive
- Construction & Civil Engineering
- Flexography (labelling) & Lithography
- Foundry & Forge
- General Manufacturing
- Military
- Power & Energy
- Rail & Mass Transit
- Shipyards
- Wood finishing

